

WORTHINGTON

DISTRIBUTION

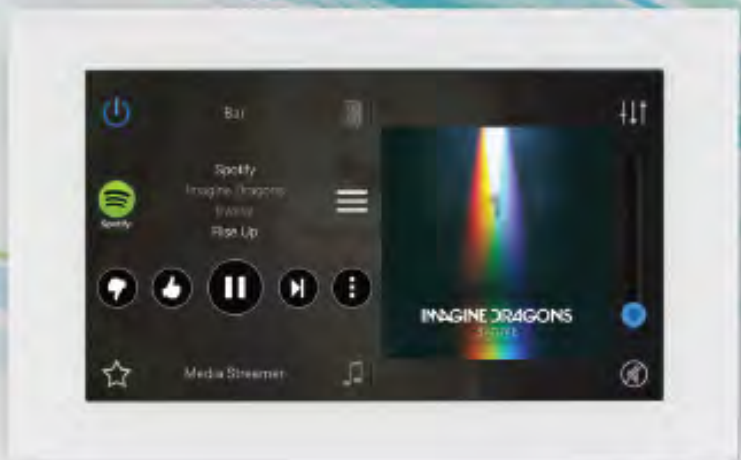
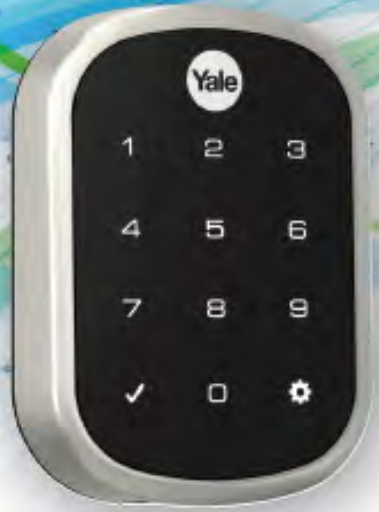

NATIONAL DISTRIBUTOR

800-282-8864 | WWW.WORThDIST.COM



Jump start a new level of comfort.

Leviton and Samsung SmartThings have teamed up to offer the perfect home automation starter kit.



LEVITON AND SAMSUNG SMARTTHINGS

Create a complete eco-system with the best partners and products. The bundled kit includes the Samsung SmartThings Hub, plus a wireless Leviton Z-Wave universal dimmer and light switch. Expand with other thermostats, sensors, audio and extra lighting controls.

Learn more at leviton.com/smartthings



THE FUTURE IS ON®

LEVITON®

Alexa and Russound



Voice Control with Amazon Alexa is now available for all of Russound's internet-connected products: MCA-66, MCA-88, MCA-88X, XSource, XZone4, and XZone70V.

Learn more about using Alexa with Russound products at www.russound.com/Alexa

Landscape Speakers



AW4-LS-BR

Landscape Satellite Speaker

- 4" woofer with ¾" PEI tweeter
- Color-molded composite design won't chip, peel or fade
- Rust-proof aluminum grille
- Adjustable 70v/100v/8Ω design
- Includes 11" mounting stake

AW10-LSUB-BR

10" Landscape Subwoofer

- Rugged PVC enclosure for underground use
- Custom tuned port tube for deep, tight bass
- Full Bandpass Design
- Adjustable 70v/100v/8Ω design
- Includes 3' burial-rated cable and weatherproof wire-nuts

WORTHINGTON STAFF

RICHARD F. SCHOLL, JR.

Founder



RICHIE SCHOLL

President

Richie has a background in information systems and has been with Worthington since its inception. His focus is on network and telephony products as well as bringing dealers the right products and systems with the support to back them up.



BARRY HAMPE

Technical Sales Manager

Barry has experience with computer systems and networking and has been with Worthington for 15 years. He has experience with nearly all the products we carry and specializes in the Z-Wave ecosystem and Omni.

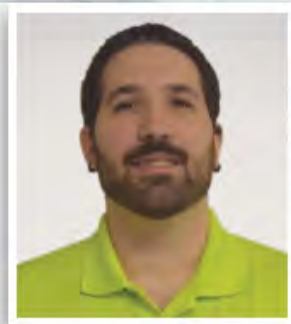

JOHN ZITZELMAN

Technical Sales

John has experience with board-level electronics and has extensive customer service experience. He specializes in automation gateways and plays a major role in the Worthington window treatment program.



STEVE HOH

Technical Sales

Steve has extensive field experience as an alarm and A/V system installer. His product specialties include surveillance systems, IP telephony, security, and commercial audio.

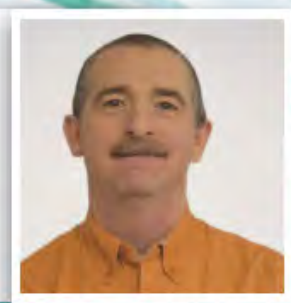

CHRIS KUBRAK

Purchasing

Chris's time on our Technical Sales Team provides him with invaluable experience in the Purchasing position. His knowledge of our systems and how they work together helps us ensure we have the products you need when you need them.



JOEL DEYOUNG

Technical Sales

Joel has broad experience with the range of Z-Wave devices that are on the market today. Joel is our Lutron champion and specializes in sales and support of Z-Wave hubs and gateways.

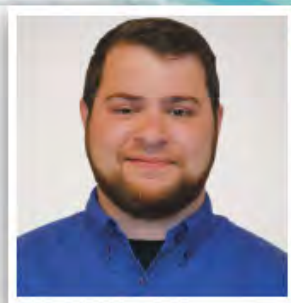

MEET THE TEAM



Business Simplified



Dear Professional Dealer/Installer,

First and foremost, we would like to thank you for your business. Our primary goal is to provide you with products that fit the needs of today's customers at the right prices. Our team of factory trained and field experienced representatives is here to help you succeed. We spend time learning the products we carry before we ever offer them for sale. They get powered up and tested with other products just as they would in the field. This allows us to provide you with first-hand knowledge on how the products work and what you can expect during your installations.

Whether you are installing an automation system, security system, A/V system, or something else, we understand that it's rarely made up of products from one manufacturer. This is just another reason that we remain focused on product knowledge. You can lean on us for tips, tricks, and advice on compatibility and successful cross-vendor solutions.

There has been a lot of discussion recently about the rise in awareness of DIY products and what that means to the professional integrator. We believe this increased awareness can only amount to more business for you. Many homeowners learn about cool products like thermostats, cameras, locks, light switches, etc., and realize that they would like to have them in their own house, but are not willing to install them. That's where you come in!

In addition to a broad selection of products geared towards residential use, we also have products that are just as at home in commercial settings. A/V control in conference rooms and meeting rooms is a common application. Worthington can supply A/V control systems that bring together lighting, displays and screens, audio gear, and more into a single user interface on a touchscreen or tablet.

We now offer pre-programming services on just about every item we sell. We'll go through a simple interview process to determine your needs and provide a quote for the work. We then send you the product configured and labeled, reducing your installation time.

If you have done business with us in the past, we greatly appreciate it. If not, we would appreciate the opportunity to earn your business. We believe you will find us easy to work with, helpful, and invested in a positive experience.

Sincerely,

Rich Scholl
Founder



Richie Scholl
President

New for 2018 Contact Worthington via SMS/Text

How to contact Worthington Sales via Text (SMS):

Number (570) 266-7122
Message Let us know what you need!

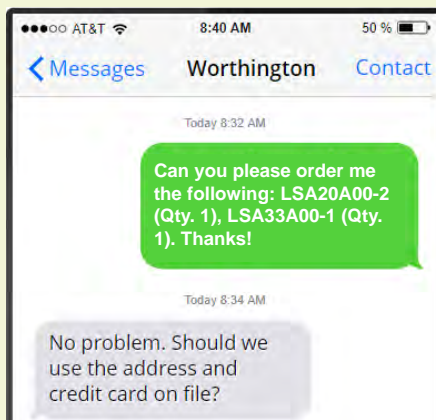
- 1) For your first text, please be sure to include your name and your company name. Future texts will not need that information unless you change phone numbers.
- 2) Texts will be handled by a member of the Worthington staff and you will receive a response typically within 30 minutes (during normal business hours).
- 3) Please DO NOT send credit card information via text. If credit card information is required, a member of the Worthington staff will contact you.
- 4) Texts can include photos if your situation requires it.



(570) 266-7122

Category Index

Z-Wave	9-33			
Accessories				
Controllers				
Garage Door/Door Locks				
Sensors				
Irrigation	43			
Lighting Control	45-67			
Boxes/Wallplates				
Centralized Dimming				
Occupancy				
Radio RA2/Radio RA2 Select/Caséta				
UPB				
ZigBee				
Energy Technologies	70-71			
Power Quality	72-73			
Battery Backup/UPS				
Structured Wiring				
Whole House Surge				
Window Treatments	75-81			
Automation	35-43, 68-69, 82-111			
Accessories				
Audio				
Controllers				
HVAC				
Interfaces				
iPad/iPod Mounts				
Lighting				
Software				
Touchscreens				
Vehicle Detection				
Wireless				
Security	112-137			
Access Control				
Accessories				
Cameras				
Contacts				
Door Strikes/Maglocks				
Environmental				
Keypad Locks				
Lighting				
Motion/Occupancy				
Panels				
Wireless				
Video Surveillance	139-147			
Cameras				
DVRs				
IP Cameras and NVRs				
Multiroom A/V	148-165			
Commercial				
Intercom				
iPod				
IR Distribution				
Multi-Source				
Single-Source				
Speakers	158-163			
All Weather				
Rock				
In-Ceiling/In-Wall				
Sound Dampening				
Subwoofers				
A/V Distribution	167-171			
Cat 5e				
Standard				
Home Theater	172-178			
Cables				
Cooling				
Mounts				
Projection				
Racks				
Speakers				
Communication	179-184			
Door Stations				
Headsets				
Intercom Systems				
IP Phone Systems				
Paging Systems				
Central Vacuum	185			
Structured Wiring	187-203			
Accessories				
Audio				
Data Modules				
Enclosures				
Phone Modules				
Power Modules				
Video Modules				
Wallplates and Inserts				
Tools	205-208			
Installation				
Labeling				
Installation Materials	209-212			
Accessories				
Brackets/Mudrings				
Wire and Cable	214-215			

Check out our sales flyer for monthly deals and savings!

Manufacturer Index

New Manufacturers	
Guardian	• Water Valve
MCO Home	• Z-Wave Thermostats
Nuvo	• Multiroom Audio
Ring	• Doorbell Camera
New Products	
Alula	• Connect+
Arlo	• Arlo Go
Centralite	• Villa
Comelit	• Visto Doorbell
HomeSeer	• 200 Series Devices
iPort	• LuxePort
Legrand	• Nuvo Audio
Leviton	• Load Center
Lutron	• Radio RA2 Select

2GIG Technologies	113-116, 130
ACNC (Doorbell Fon)	184
Aeotec	19
Alarm.com	116
Alarm Controls	90, 137
Altronix	133, 142, 145
Alula	89, 116, 123-125
Aprilaire	107
Arlington	49, 156, 209, 211
Arlo	147
ATW Security	87-88, 122
August	27
Belden	191, 206-207
BitWise	35, 93
Carlson	210, 212
Cartell	111
CasaTunes	95, 152, 158
Centralite	65-67
Channel Vision	202-203
Comelit	183
Dakota Alert	109
DataComm	201
Dome	21
Domotz	69
Draper	175
DSC Security	12, 88, 117-121, 123
Dymo/Rhino	205
Dynamat	166
ELK Products	102-106, 116, 131, 133
Encore	130
ESI	80-81
EverFocus	145
Fibaro	10-11

FortrezZ	29	Optoma	175
Global Cache	12, 36	PCS	60-61
Grandstream	12, 92, 180-181	Platinum Tools	191, 206, 208
Greenfield	96	Proficient Audio	160-164
GRI	88, 134	Rachio	12, 43
Guardian	40	Radio Thermostat	31
Harmony Remotes	41	RCS	31
HomeSeer	19, 23	Ring	37
IntelliTouch	182	Russound	12, 148-156, 158
Ion Security	89, 116, 122	Schlage	26, 31, 33
iPort	39	Seco-Larm	137
Jasco	33, 90	SensorSwitch	88
JBL	173	Sillites	83
Keri Systems	136	Simply Automated	62-63
Key Digital	168-169, 172	SmartThings	16
Kwikset	24, 90, 113	Snom	180-181
Legrand	59, 193-199	Somfy	77-79, 99
Leviton	15-17, 59, 70-73, 89, 91-92, 94-95, 158, 182, 188-192	Speco Technologies	140-143, 165
Leviton Omni	86-87, 89-90, 92, 97, 99-103	Stelpro	31
Logenex	12, 182	System Sensor	88, 130
Lutron	48-58	Telguard	123
Luxul	68-69, 92, 141, 182	Trane	31
Macurco	88, 130	Tripp-Lite	73, 145
MCO Home	31	URC	40
Middle Atlantic	73, 176-177	United Security	135
Muxlab	140, 171	Vera Control, Inc	18
Napco	88, 123, 127-129	Visonic	122
Nest	42-43	Wavenet Wire	145, 152, 155, 214-215
Nortek (Linear)	23	Wheelock	130
NuTone	185	Wilson (zBoost)	123
Nuvo	159	Winland	135
Optex	88	Xantech	157
		Yale	25, 90
		Zipato	13

The Worthington Difference

Knowledge Base

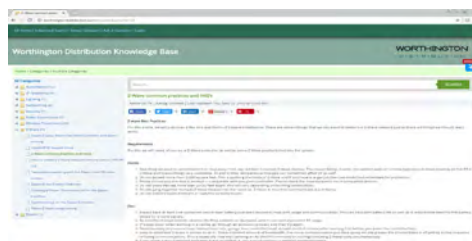

- Product Information
- Product Tips
- How-to-Articles
- Common Practices and FAQs

<http://www.worthingtondistribution.com/kb/>

Webinars and Online Trainings



- Recorded Webinars and Online Trainings
- Worthington University Schedule and Sign Up
- Manufacturer Trainings

<http://www.worthingtonu.com>

Nuvo®

whole-home audio designed with the complete solution in mind.



P500 | Sound Bar and Subwoofer

Why Nuvo?

From easy installation to seamless integration, Nuvo's design principles are built around supporting the needs of professional integrators. Dedicated to engineering exceptional and innovative products for multi-room audio, our passion for music is matched only by our desire to deliver it with brilliant quality – to any (or every) room of the home.



P400 | Tabletop Speaker

In-Wall Control



P30 | 7" Android Touch Screen



P20
In-Wall Keypad

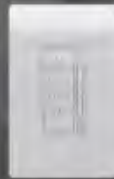

P10
In-Wall Keypad

Professional Rack-Mount Players



P4300 | 3 Zones at 110 Watts per Zone



P3100 | 3 Zones at 40 Watts per Zone

Wireless Players



P300 | 1 Pre-Amp Zone



P100 | 1 Zone at 40 Watts



P200 | 1 Zone at 120 Watts



Designed by Audiophiles. Installed by Professionals.

Learn more at www.legrand.us/nuvo

 **legrand**®

Understanding Z-Wave Technology

A Mesh Network

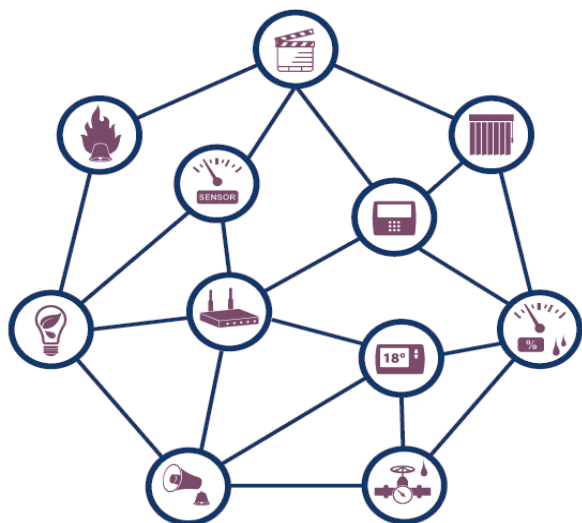

- Z-Wave is a 900MHz radio frequency mesh network communication technology which allows devices in the home to work together
- A key advantage of Z-Wave is that all Z-Wave devices can be added to any Z-Wave network
- Z-Wave is a communication standard at both the radio and protocol level. This ensures all Z-Wave products can work together (see Z-Wave - Interoperability for further details).
- Being a mesh network, Z-Wave uses other devices already on the network to deliver messages from one device to another. This applies to all devices that are plugged in or permanently powered. Battery devices do not repeat messages.
- The more devices that exist on a Z-Wave network, the better the network coverage
- To achieve Z-Wave certification, a Z-Wave device must be able to achieve 131' open air communication
- Due to construction materials and large metal objects, plan on typical installed communication distances of 30' to 35'

Interoperability



- Z-Wave devices are designed to be learned into any Z-Wave controller. Certain controllers may limit functionality with some Z-Wave devices.
- The most important example of product differentiation in the Z-Wave ecosystem centers around lighting devices. To know if a light is on or off, the controller should poll the device for a status update. Leviton devices are unique because they have the ability to tell a controller or keypad that their status has changed without being polled.

Primary Controller

- Every Z-Wave network is created with a primary controller
- The primary controller is responsible for adding and removing devices to the Z-Wave network



• Gateway Controller

- A gateway controller often (but not always) connects to a Local Area Network (LAN) and provides Z-Wave control in the home and from mobile interfaces such as an iOS device or Android phone
- Gateway controllers allow for advanced network maintenance functions, lock communication setup, and some provide interfaces to other technologies

Network Wide Inclusion (NWI) and Explorer Frames

Network Wide Inclusion (NWI) was developed to make the installation of new devices into a Z-Wave network easier. NWI will use the existing devices in your Z-Wave network to route the information about the new device being added to the controller that is handling the inclusion process. NWI started to appear in devices in 2011, and a large number of the total devices in your network as well as your inclusion controller, have to support NWI for the technology to work.

The Explorer Frame technology started appearing in 2013. It is used when the regular Z-Wave routing fails, perhaps because a Z-Wave node was unplugged or it failed.

All devices with the Z-Wave Plus mark will have NWI and support for Explorer Frames. Check the catalog of Certified Z-Wave Products at <http://Products.Z-WaveAlliance.org>; the advanced search allows you to look for devices supporting NWI and the Explorer Frame.

Certified Installer Toolkit (CIT)

The Certified Installer Toolkit (CIT) is a tool for installers to test a Z-Wave network prior to completion to ensure a robust, reliable mesh network is in place. It is a powerful tool for troubleshooting and diagnosing problems. It may be left behind for logging or even permanent off-site maintenance.

Developed by the Z-Wave Alliance with the latest capabilities & offerings, the Z-Wave Certified Installer Toolkit is a versatile tool for every installer:

- Comprehensive network diagnostics & device management, accessible from anywhere in the world
- Rapidly identifies potential problems
- Spectrum analyzer shows noise in the Z-Wave channels
- Routing table displays which nodes are neighbors
- Network map graphically displays how nodes are connected to each other
- Z-Wave network sniffer (ZNIffer) shows what is actually sent by nodes and identifies the type of message
- Displays advanced node information such as device version, battery level, Z-Wave library version, and more
- Access to Z-Wave device product information including manuals and technical data
- The CIT may be left at a site for long-term testing allowing you to connect to it remotely

The CIT is Z-Wave Plus certified as a controller. As a fully capable controller it can set configuration parameters and communicate with all nodes on the network, including those using Z-Wave S0 security.

The CIT is available only to Z-Wave Alliance members. Purchase a CIT from Worthington Distribution and get your first year for only \$1 (\$250 auto-renew for second year). Contact Worthington Distribution to learn about the benefits of integrator membership in the Z-Wave Alliance and the latest Z-Wave products available for you to start installing today.

Troubleshoot and diagnose Z-Wave networks.



Fibaro is a leading manufacturer of residential IoT solutions and designs. They are engineers and manufacturers of innovative and compact smart home devices that make up the advanced home intelligence platform, known as the Fibaro System. Many of Fibaro's sensors have built-in Z-Wave network range testers, support wireless firmware updates, and features network wide inclusion.

Fibaro's wireless Z-Wave smart home system can be controlled from anywhere in the world via smartphone, laptop and/or tablet. The system, along with a suite of Fibaro accessory devices and sensors allows users to create easy-to-access scenes, manage energy usage, and integrate hundreds of devices including cameras, lights, locks, shades and numerous household systems, including entertainment.

Home Center Controllers

The Fibaro Home Center controllers are comprehensive Z-Wave gateways with a stunning user interface, full home control, and automation capability. They include an extensive library of 3rd party plug-ins for smart TVs, VOIP (HC2 only), cameras, thermostats, alarm panels, and media players. AV integrations can be made with Virtual Device Creation via RS232 or HTTP as well. Home Center 2 also allows for legacy alarm integration and includes a detailed energy management panel.

Features	Home Center 2 (HC2)	Home Center lite (HCL)
Graphic Scene Editor	Yes	Yes
LUA Programming	Yes	No
LUA Based Scenes	Yes	No
LUA Based Devices	Yes	No
Virtual Multimedia devices	Yes	Yes
Amazon Alexa	Yes	Yes
Google Assistant	Yes	Yes
Voice Over IP server	Yes	No
Processor	Intel Atom 1.6Ghz	ARM Cortex-A8 (720MHz)



FIBFGHC2

FIBFGHCL

FIBFGHCL	Fibaro Home Center Lite	227.31
FIBFGHC2	Fibaro Home Center 2	608.88

For information on third party plug-in's, see page 12!

Home Center Controller's Interface



The Home Center's interface allows you to install additional sets of icons for rooms, devices, scenes, etc., without having to interfere with the graphics. Fibaro has also made it possible to change the arrangement of particular icons and to move them about in such a way so that the ones used most frequently are always close at hand. The "Everyday Activities" bar has been designed for users to create their own shortcuts to the scenes they use most often.

iOS and Android Apps



This rich user interface makes it easy to find things on the fly. With quick links to rooms or devices, you can have control at your fingertips in no time at all. With iOS and Android apps, we have a solution for any homeowner!

Main Web interface



The main panel in the web interface gives you access to the entire system. With 1 click you could be anywhere in the system you'd like.

Consumption Panel



The consumption panel will give you a full system total on power consumption from whole house monitors down to single device estimations.

Sensors

Fibaro manufactures a family of innovative and well-designed Z-wave sensors, switches, and controllers. They have been successful in Europe for years and are now making their products available in the US, with a domestic presence to fully support them. Fibaro sensors are some of the best-looking available, and they have some very innovative features. Many sensors have Z-Wave range testing included, which is a valuable installation tool (see full explanation below). Fibaro also makes a micro-dimmer that can Z-Wave enable any standard light switch. When it comes to Z-Wave hubs, the Fibaro Home Centers sets themselves apart through simple auto-inclusion and an elegant user interface.

Door/Window Sensor 2

- Compact sensor comes in white (Other colors coming soon)
- Internal temperature reading
- Dual tamper (opening device or movement)
- Binary input terminal allows for additional expandability of wired binary devices (smoke, CO, motion detectors)
- Binary input can incorporate push button switches
- Remote auto firmware update (HCL or HC2)
- Scene activator for lighting and security system



FIBFGDW-002-1US Door / Window Sensor 2 - White 40.58

*Only Available in White - For other colors call 800-282-8864

Flood Sensor

- Universal, Z-Wave-compatible, water and temperature sensor
- Battery or VDC powered (12/24VDC)
- Alarm panel integration capable
- Built in LED indicator and acoustic alarm
- Dual tamper protection (movement or opening device)
- Built-in Z-Wave network range tester
- Remote automatic firmware update with HCL or HC2



FIBFGFS-101 Fibaro Flood Sensor 48.70

Motion Sensor

- Wide angle, ultra sensitive detection with finite adjustment capability
- Visual color LED alerts of temperature, alarms, and battery status
- User selected color alert, intensity, duration, or off
- Built in Z-Wave network range tester
- Convenient small size and tamper protection



FIBFGMS-001ZW5 Fibaro Motion Sensor 48.70

Scene Control

Button



This small but very powerful Fibaro Button allows the user to run five preprogrammed scenes along with a Panic Scene. Different scenes can be triggered with a single push, double push, or by holding the Button down. This useful device is battery powered and comes in 8 different colors.

FIBFGPB-101-* Fibaro Button 40.58

* 1-White, 2-Black, 3-Red, 4-Yellow, 5-Green, 6-Blue, 7-Brown, 8-Orange

The Fibaro KeyFob is a Z-Wave Plus compatible, battery-powered, compact remote control. Six buttons allow you to control other devices through the Z-Wave network and run various scenes defined in Fibaro System. Configure actions for one, two, three clicks and holding the button to suit all your needs. Built-in locking system will ensure that unauthorized persons will not take control of your home.



FIBFGKF-601 Fibaro 6-button KeyFob 40.58

Swipe

The Fibaro Swipe is a revolutionary gesture-control pad that provides control of home automation devices within the Fibaro eco-system without actually touching anything. The control is made possible by associating a gesture to a command. The placement and possibilities of the Fibaro Swipe are truly endless. Mount Swipe under the countertop or behind the wall for completely seamless integration. Imagine swiping up to open the roller shades, swiping down to turn off the lights, swiping right and the music comes on, swiping left to turn the TV on. With four short swipes, the living room is transformed into a home theater! The Swipe's only limit is your imagination.



FIBFGG-001 Fibaro Swipe 122.40

Wall Plug

The Fibaro Wall Plug is a 15 amp plug-in module with power metering built in. The Wall Plug is one of the smallest on the market with a built in USB receptacle with constant power to charge all of your favorite devices. The LED ring will give you real-time power consumption. One of the best features is getting notifications based on power consumption!



FIBFGKF-601 Fibaro Wall Plug - With USB outlet 40.58

FIBFGWPB-111ZW5 Fibaro Wall Plug - No USB outlet 40.58

RGBW Controller

FIBFGRGBWM-441 RGB/RGBW Controller for compatible LED color changing lights 56.82

The Fibaro RGBW Controller is a universal, Z-Wave compatible module that controls LED, RGB, RGBW strips, halogen lights and fans via 12/24VDC. Change the color of the lights right from your mobile device. The controller supports up to four 0-10V passive analog sensors such as temperature sensors, humidity sensors, wind sensors, air quality sensors and light sensors. All IN and OUT terminals may be user-configured for LED control 0-10V signal readouts.



Use the preconfigured scenes or create your own custom RGBW scenes for a personalized lighting experience.

Actors

FIBFGD-212 Dimmer 2 Universal Dimmer 48.70

FIBFGS-213ZW5 Single Switch 2 48.70

FIBFGS-223ZW5 Double Switch 2 48.70

Fibaro load controllers are designed to fit in a wallbox behind existing switches. They can also be used anywhere control is desired.



Install the Fibaro Actors into locations where you don't want to replace the existing switches and dimmers.

Audio Plug-ins

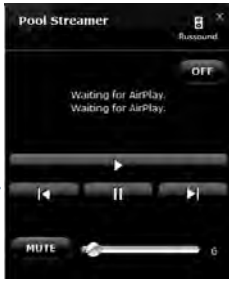

Fibaro offers plug-ins for Russound's streaming devices including the Russound MCA88X, XSOURCE, XZONE4, and XZONE70V. The plug-in will give you the ability to control your sources, volume control and play/pause and skip functions. Only compatible with the Home Center 2.

RSXSOURCE	Russound Single Source Streamer	255.84
RSXZONE4	Russound 4 Zone Streaming amplifier	1,215.76
RSXZONE70V	Russound 4 Zone Streaming 70V Amplifier	743.60
RSMCA-88X	Eight Source, Eight Zone Controller Amplifier with built in streamer	1,818.96

You can view the entire Russound product line on pages 148-156.

Irrigation Plug-ins



Rachio is a wi-fi operated smart sprinkler controller that can handle either 8 or 16 zones of sprinklers. You can save up to 50% on water expenses just by switching to Rachio! Integrate it with your smart lighting and schedule it based on weather and other events.

RAC8ZULW	Rachio 8 Zone Sprinkler Controller	159.87
RAC16ZULW	Rachio 16 Zone Sprinkler Controller	199.84

Security Integration Plug-ins



The Fibaro Home Center Controllers will integrate with the DSC Powerseries panels to create not only a very robust security system but you will also have the ability to trigger automation based on the state of the sensors on the DSC panel. This integration requires an IP bridge from Global Cache. The Global Cache GCIP2SL will give you the ability to go from the DSC IT100 hardwired serial module to an IP communication speaking with the Home Center Controller.



DSCIT100

DSCIT100	Serial Interface Module	53.51
----------	-------------------------	-------

You can view the entire DSC product line on pages 119-121

Security Integration Plug-ins



The Global Caché family of connectivity products provides choices for the industry professional and the consumer – significantly reducing costs and providing a scalable platform for today and the future.



GCIP2SL

GCWF2IR	Wireless to IR, control IR devices over Wi-Fi, 3 emitters, 1 blaster, power supply	109.91
GCIP2IR	Wired to IR, control IR devices over IP, 3 emitters, 1 blaster, power supply	91.18
GCWF2SL	Wireless to serial, control serial over Wi-Fi, power supply	109.91
GCIP2SL	Wired to serial, control serial over IP, power supply	91.18

You can view the entire Global Cache product line on page 36.

IP Phone/Intercom Integration

Fibaro offers a SIP server exclusively with the Fibaro Home Center 2, which means we have the ability to program phone extensions and create a local/remote phone system. This also means that we can include an outdoor video intercom unit to work with the phones inside your home.

GRAGXV3275	Grandstream Android powered 7" color touchscreen desk phone with camera	180.59
LSAINDS1-S	Leviton IP enabled SIP door station	498.60
LGXTPC	Logenex Teleport IP Door station controller only	389.33
LGXTP202XVC	Surface mount IP video door station with panning camera	200.64



For a complete listing of Grandstream IP phone options, please refer to pages 180-181.



GRAGXV3275



LSAINDS1-S



LGXTP202XVC

Camera Integration Plug-ins

Integration with security cameras doesn't get any more seamless than this. All you need to do is download the Speco Technologies Plug-in specifically for your camera and you can then add it to your Fibaro via an IP address to view your live feed. Not all Speco Cameras are supported at this time. Call for more details.



You can view the entire Speco Technologies product line on pages 140-143.



Zipato Automation Controllers



ZipaTile with Z-wave and Zigbee is the complete home control system in the form of a single device. It can be easily mounted on any wall, in any home. Featuring a large number of built-in sensors and hardware modules, ZipaTile will replace numerous home devices such as a security system, thermostat, automation controller, IP camera, alarm siren, or intercom. This brings it all together in one, smart and beautiful device.

- SIP Server client
- Door phone control
- Conference calls
- Video calls
- Dual-network IP connectivity
- Remote control with smartphone



ZIPZTWUSZBEE	Zipatile touchscreen controller with Z-Wave AND ZigBee Android powered - Black	298.22
ZIPZTWUSZBEEWH	Zipatile touchscreen controller with Z-Wave AND ZigBee Android powered - White	298.22

Zipabox Controller



Zipabox is a next-generation automation controller that lets you control all of your home electronics. Most often it uses simple, reliable, low-power radio waves that easily travel through walls, floors and cabinets but it can also use existing powerlines or BUS wires to connect your home electronics. Zipabox can control many electronic devices in your house, such as appliances, window shades, thermostats, and home lighting.

Zipamicro Controller

Zipamicro is a new release from Zipato and is a Z-wave Controller for connecting and managing smart home devices. At its core, the Zipamicro is running Zipato's Local Server which is an essential part of the Zipato platform, The world's most versatile Smart Home platform. The Zipamicro includes Z-Wave's latest 500 series chipset and works with a wide range of 3rd party devices including Nest, Philip Hue and many more!



ZIPZBWUS	Expandable Z-Wave Automation Controller	156.59
ZIPZMWUS	Zipamicro Z-Wave Automation Controller	70.03

Ziapro Zipabox Expansion Modules



ZIPZBMBACKUPV2	Provides whole system with up to 24 hours of power autonomy	77.90
ZIPZBMZIGBEE	Add ZigBee to Zipabox	46.43
ZIPZBMSERIAL	Add RS-232/485 and USB to Zipabox	38.56
ZIPZBMSECURITY	Add up to 6 wired security zones and RS-232/485 to Zipabox	109.37
ZIPZBMPower	Add power metering for 4 circuits to Zipabox	117.24
ZIPAMPCLAMP35	AC current sensor with DC male plug. For use with the power module	19.67



Zigbee Security Sensors

ZIPPHPSG01US	Smoke Sensor, Zigbee	46.43
ZIPHMHS1CAM	Carbon Monoxide Sensor, Zigbee	46.43
ZIPHMHS1CGMUS	Gas sensor, Zigbee	38.56
ZIPHMHS1WLM	Flood Sensor, Zigbee	22.82



ZIPHMHS1CAM



ZIPPHPSG01US



ZIPHMHS1CGMUS



ZIPHMHS1WLM



Accessories

ZIPHPAN08US	MicroModule motor controller, 230V for blinds, shutters, etc., 1.8 amp max. output	46.43
ZIPHPSE02US	Multi-sound indoor siren	62.16
ZIPLNRTL8152	USB to Ethernet adapter - Zipatile only	22.82
ZIPWTRFIDUS	Z-Wave Mini Keypad w/ RFID	46.43
ZIPHPSM02US	Multi-sensor quad, door/window contact, presence detector, temperature sensor, and light sensor	46.43



ZIPHPSE02US



ZIPLNRTL8152



ZIPWTRFIDUS



Open to Anything!



2GIG Vario System. Hybrid Wireless/Wired Security. For Commercial and Residential.

We believe that the best devices have no limits. That's why we've left the 2GIG Vario Panel open. Open to all applications. Open to all types of customers. Open to all accessories. Vario Hybrid Wires/Wireless Security & Control Solution meets the needs of both the residential and the commercial customers.

 **2GIG.**
VARIO



Visit 2GIG.com for more information on the latest Smart devices with features your customers will love.

decora smart™ Wi-Fi

Leviton offers a revolutionary new innovative Wi-Fi based lighting system that uses your Smartphone. Simply download the free app which is available for Android and iOS devices. The app is used to control the system, and it also adjusts scenes and schedules that are built into the devices. This allows for a full lighting system, **no hardware controller needed!** Keep an eye out later this year for integration with other home automation devices from other manufacturers.



1  **Decora Smart Switch**

2  **Decora Smart 600W Dimmer**

3  **Decora Smart Plug-in Dimmer**

4  **Decora Smart Plug-in Outlet**

5  **Decora Smart 1000W Dimmer**

6  **Voice Control and Activation**

7  **Remote access and control**

Keep an eye out for cloud-to-cloud functionality with other manufacturers coming soon!

decora® smart™



LEVDW1KD-1BZ

LEVDW15S-1BZ

Dimmers

LEVDW1KD-1BZ	Dimmer, 1000W incandescent, 450W CFL and LED, 1000VA Mark 10 ballasts, 120VAC. Neutral required.	49.95
LEVDW6HD-1BZ	Dimmer, 600W incandescent, 300W CFL and LED, 120VAC. Neutral required.	44.95
LEVDD00R-DLZ	Matching remote dimmer with LED indicator. Neutral required.	14.00

White and Light Almond included.
Call for Ivory, Gray, Black, and Brown color change kits.

Switches

LEVDW15S-1BZ	Switch, 15A, 120VAC. Neutral required.	44.95
LEVDD0SR-1Z	Coordinating remote switch, no LED indicator.	18.15
LEVDD0SR-DLZ	Matching remote switch, with LED indicator. Neutral required.	20.73

White and Light Almond included.
Call for Ivory, Gray, Black, and Brown color change kits.

Plug-Ins



LEVDW3HL-1BW

LEVDW15A-1BW

LEVDW3HL-1BW	Plug-In Dimmer, 300W incandescent, 100W CFL and LED. 120VAC	39.96
LEVDW15A-1BW	Appliance Module, 15A, 120VAC	39.96

Want to use Leviton decora smart WiFi with your Omni system? Give us a call to find out how!

decora smart™ Home Kit

Hey Siri®,
Turn On my...
Smart Home from Leviton



LEVDDH1KD-1BZ	Dimmer, 1000W incandescent, 450W CFL and LED, 1000VA Mark 10 ballasts, 120VAC. Neutral required.	49.95
LEVDDH6HD-1BZ	Dimmer, 600W incandescent, 300W CFL and LED, 120VAC. Neutral required.	44.95
LEVDDH15S-1BZ	Switch, 15A, 120VAC. Neutral required.	44.95
LEVDD00R-DLZ	Matching remote dimmer with LED indicator. Neutral required.	14.00
LEVDD0SR-DLZ	Matching remote switch, with LED indicator. Neutral required.	20.73

White and Light Almond included.
Call for Ivory, Gray, Black, and Brown color change kits.

SmartThings



Whole House Automation
Made Simple



Start your next smart home project with the Samsung SmartThings Hub and Leviton Vizia RF + bundle. Wirelessly control lighting in the home to protect property, save energy, and make everyday living more fun with app control and automation. Set Leviton lighting controls to activate when there's motion, or turn off when there isn't, and automate multiple lights with one button. Connect all of your smart devices to one hub for simple control of your home. SmartThings is a refined hub that allows for powerful user control.

SmartThings uses geofencing to work with your favorite Leviton products!

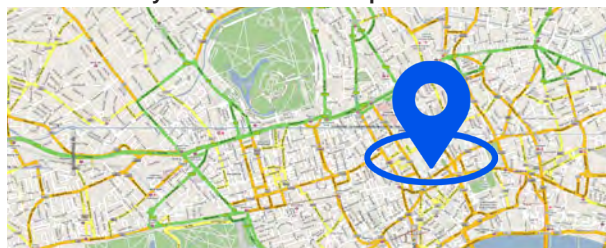

LEVSTKIT-2DS	SmartThings Bundle. Includes the SmartThings Hub, (1) LEVDZ6HD-1BZ Dimmer and (1) LEVDZ15S-1BZ Switch	189.85
--------------	-------------------------------------------------------------------------------------------------------	--------

LEVDZ6HD-1BZ	Z-Wave Plus 600W Dimmer, 120VAC.	44.95
--------------	----------------------------------	-------

LEVDZ15S-1BZ	Z-Wave Plus 15A Switch, 120VAC.	44.95
--------------	---------------------------------	-------

White and Light Almond included

Works with SmartThings



SmartThings can talk to your favorite Z-wave and Zigbee devices. Give us a call to learn more about water valves, locks, specialty sensors, cameras, voice assistants, and more!

decora smart™ Z-Wave



LEVDZ1KD-1BZ

LEVDZ15S-1BZ

The new Decora Smart™ with Z-Wave Plus Technology family of products features five devices including in-wall dimmers, a switch, and plug-in modules for appliances and lamps. The family of solutions utilizes the latest generation of technology for advanced wireless lighting control products. In-Wall Dimmers and switches boast the new Leviton design with true rocker action, pressing the top to turn on and the bottom to turn off. Vanishing LEDs to the left of the Dimmer paddle show current and target light level with real-time feedback.

Z-Wave Switches

LEVDZ15S-1BZ	Z-Wave Switch. 15A, 120VAC. Neutral required.	44.95
--------------	-----------------------------------------------	-------

LEVDD0SR-1Z	Coordinating remote switch, no LED indicator	18.15
-------------	----------------------------------------------	-------

LEVDD0SR-DLZ	Matching remote switch, with LED indicator. Neutral required.	20.73
--------------	---------------------------------------------------------------	-------

White and Light Almond included.

Call for Ivory, Gray, Black, and Brown color change kits.

Z-Wave Dimmers

LEVDZ1KD-1BZ	Z-Wave Dimmer. 1000W incandescent, 450W CFL and LED, 1000VA Mark 10 ballasts, 120VAC. Neutral required.	49.95
--------------	---------------------------------------------------------------------------------------------------------	-------

LEVDZ6HD-1BZ	Z-Wave Dimmer. 600W incandescent, 300W CFL and LED, 120VAC. Neutral required.	44.95
--------------	-------------------------------------------------------------------------------	-------

LEVDD00R-DLZ	Matching remote dimmer with LED indicator. Neutral required.	14.00
--------------	--------------------------------------------------------------	-------

White and Light Almond included.

Call for Ivory, Gray, Black, and Brown color change kits.



LEVDPD3-2BW

LEVRR15-1LZ

LEVDZ15S-1BZ

Z-Wave Plug-Ins

LEVDPD3-2BW	Z-Wave Plug-In Dimmer. 300W incandescent, 100W CFL and LED. 120VAC.	27.35
-------------	---------------------------------------------------------------------	-------

LEVDZ15S-1BZ	Z-Wave Appliance Module. 15A, 120VAC.	44.95
--------------	---------------------------------------	-------

LEVRR15-1LZ	Tamper Resistant split outlet 15A Top controlled bottom on. 300 series. White, Ivory, and Light Almond colors included.	51.83
-------------	-------------------------------------------------------------------------------------------------------------------------	-------

Works With SmartThings: Lumina RF

Leviton's powerful wireless Lumina RF products ensure energy savings in new construction and retrofit, controlling lamps, fans, shades, pumps, and more! These devices are compatible with Samsung SmartThings. This 2.4GHz mesh network technology has a proven track record in light commercial applications for distance and reliability. Lumina RF solutions are ideal for restaurants, cafes and coffee shops, retail shops, franchise stores, small and private office spaces, and more.

Lumina RF Load Control Options



LSAZSS10-G0Z

LEVDL3HL-1BW	Lumina RF Plug-In Dimmer. 300W incandescent, 100W CFL and LED.	34.96
LEVDL15A-1BW	Lumina RF Plug-In Appliance Module. 15A.	34.96
LEVDL1KD-1BZ	Lumina RF Dimmer. 1000W incandescent, 450W CFL and LED, 1000VA Mark 10 ballasts.	49.95
LEVDL6HD-1BZ	Lumina RF Dimmer. 600W incandescent, 300W CFL and LED	44.95
LSAZSS10-G0Z	Lumina RF Switch. 10A,120-277VAC. No neutral.	69.94
LSA73A00-3ZB	Lumina RF Heavy duty load control module. 30A, 120/240VAC.	179.54

Lumina RF Sensors



LSALURMD-W



LSALURDW-W

LSALURDW-W	Lumina RF Door/Window contact	37.35
LSALURMD-W	Lumina RF Motion Detector	51.96

Thermostats



LSARC1000WHZB



Easily adjust the display

LSARC1000WHZB	Lumina RF Thermostat: conventional single stage, heat pump and dual fuel systems	208.46
LSARC2000WHZB	Lumina RF Thermostat: conventional 2 stage, 3 stage heat pump, dual fuel systems, humidity and dehumidification	248.36

Vizia RF + Programming Tools and Serial Interface

LEVVR0P-1LW*	Vizia RF + plug-in Z-Wave serial interface with beaming support, Use with Omni controllers. Includes RJ-11 and standard serial cable.	89.15 or FREE
LEVVRUSB-1US*	USB adapter for use with the Leviton Vizia RF + Installer software	69.92

Download the FREE Vizia RF + Installer Software from www.leviton.com/rfinstaller



LEVVRUSB-1US*



LEVVR0P-1LW*

Receive a FREE Vizia RF + serial module when purchasing \$500 of Vizia RF +. Call for details.

* Not compatible with SmartThings

Vizia RF + Scene Controllers

Scene Controllers

- 4 Buttons (single push)
- Dim / Bright
- IR Receiver
- Control scenes On / Off



LEVVRCS4-M0Z*

* Not compatible with SmartThings

LEVVRCS4-M0Z*	Vizia RF + 4-Button Scene Controller: 4 buttons, dim, bright, IR, beaming support	109.55
---------------	-----------------------------------------------------------------------------------	--------

White, Ivory, and Light Almond included

Vizia RF + Zone Controllers

Zone Controllers

- 4 On / Off Rockers (Left on, Right off)
- Dim / Bright
- IR Receiver
- Control loads On / Off



LEVVRCS4-M0Z*

* Not compatible with SmartThings

LEVVRCS4-M0Z*	Vizia RF + 4-Button Zone Controller: 4 on/off rockers, dim, bright, IR, beaming support	115.03
---------------	-----------------------------------------------------------------------------------------	--------

White, Ivory, and Light Almond included

Vera Control, Inc. Vera Smart Home Controller



MICVERAEDGE-US



MICVERAPLUS-US

Easy yet powerful one-app control for cameras, door locks, sensors, thermostats and other home automation and security devices (sold separately) you can view and control from anywhere. Create custom scenes and sequences. Use a smart phone, tablet or computer for control and set up. Provides home and small business security, energy savings and peace of mind. Compatible with 1200+ devices from most major brands.

MICVERAEDGE-US	VeraEdge Smart Home Z-Wave Controller	74.94
MICVERAPLUS-US	VeraPlus Smart Home Controller with Bluetooth, ZigBee, and Wi-Fi features	112.41

Worthington carries many Z-Wave enabled products to use with the Vera line of controllers. See pages 10-33 or call for details.

IP Cameras



MICVISTACAM-700



MICVISTACAM-900



MICVISTACAM1101

MICVISTACAM-700	1280 x 720 High Definition 720p Pan/Tilt Wireless Camera, Microphone, IR Night Vision, SD Card Support	81.18
MICVISTACAM-900	1920 x 1080 High Definition 1080p ePTZ Wireless Camera, Microphone, IR Night Vision, SD Card Support	138.64
MICVISTACAM1100	1280 x 720 High Definition 720p Outdoor Wireless Camera, Microphone, IR Night Vision, SD Card Support	221.07
MICVISTACAM1101	1920 x 1080 High Definition 1080p Wireless Camera, Microphone, Weatherproof Enclosure, IR Night Vision, PoE, Motion/Audio detection	177.36

For more HomeSeer products see page 23.

100 Series Dimmers and Switches

HSHSWD100	Z-Wave Plus dimmer, 600W incandescent, 150W LED/CFL, White	43.44
HSHS-WS100+	Z-Wave Plus switch, 15A, 900W incandescent, 200W LED/CFL, 1/2HP motor, White	37.78
HSHS-WA100+	Companion switch for HSHSWD100 and HSHS-WS100+, supports up to 5-way	18.42

Light Almond color change kits available. Call for details.



HomeSeer dimmers and switches support additional features for Home Automation. Double-tap, triple-tap, and press-and-hold.

HSHS-WS100+, HSHSWD100 and HSHS-WA100+ shown in a Lutron Claro Wall-plate (LUCW3WH - See Page 55).

200 Series Dimmers and Switches

Wall Switches with RGB LED Indicators

- Includes wall dimmer, wall switch and fan controller
- Displays load status in your choice of 7 colors
- Can be programmed to glow / blink colors when things happen in your home
- Supports multi-tap event triggers (up to 5-taps)
- Advanced Z-Wave Plus technology
- Supports S2 security
- Easy screw terminal installation

HSHS-WD200+	200 Series Z-Wave Plus dimmer, 600W incandescent, 150W LED/CFL, White	48.05
HSHS-WS200+	200 Series Z-Wave Plus switch, 15A, 900W incandescent, 200W LED/CFL, 1/2HP motor, White	43.68
HSHS-WA100+	Companion switch for 100 and 200 series dimmers and switches, supports up to 5-way	18.42

Light Almond color change kits available. Call for details.

RGB LED indicator functionality requires a Z-Wave controller such as the HomeSeer HT-ZEE (See page 23). Please give us a call regarding compatibility with other Z-Wave Controllers.

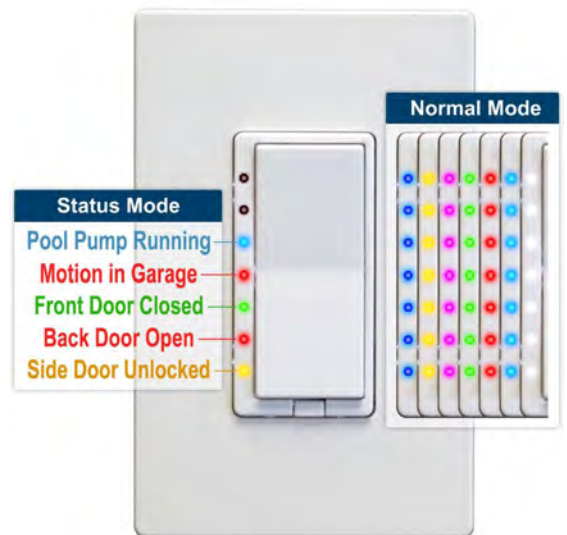

HSHS-WD200+ Shown

Box/Fixture Mount Modules

AEOZW139-US	Nano Switch module, 15A	35.82
AEOZW116-US	Nano Switch module, 15A with load monitoring	37.87
AEOZW140-US	Dual Nano Switch module	46.75
AEOZW132-US	Dual Nano Switch module, 15A with load monitoring	48.04
AEOZW111-US	Nano Dimmer module with load monitoring, 150W, Z-Wave Plus	46.74
AEOZW141-US	Nano Shutter. Convert motors to Z-Wave Plus	CALL
AEOZW150-US	Nano Dimmer Bypass, use with less than 20W loads	10.36



AEOZW111-US



AEOZW150-US

Other Devices

AEOZW129W	2-button Wallmote, white	53.97
AEOZW130W	4-button Wallmote, white	53.97
AEOZWA003-US	NanoMote Quad, 4-button keychain sized Z-Wave remote	CALL
AEOZWA004-US	NanoMote One, 1-button keychain sized Z-Wave remote	CALL

Smart Energy Interfaces

AEOZW095-US	Gen5 energy meter, highly accurate power factoring	73.95
-------------	----------------------------------------------------	-------

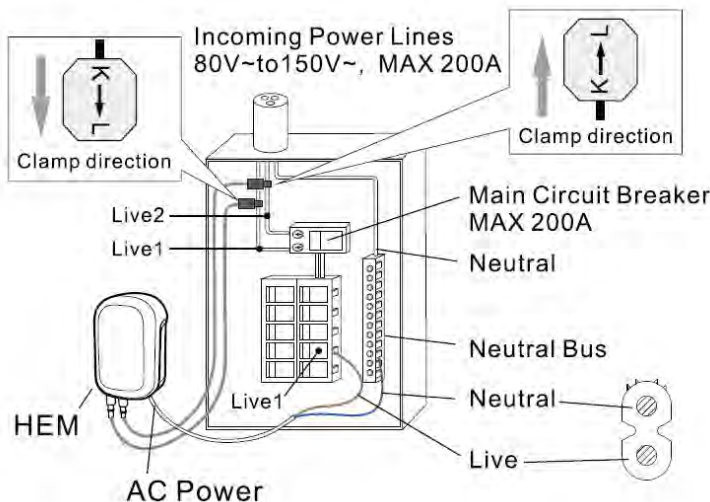

Load Control Modules



AEOZW121-A



AEOZW096-A02

AEOZW096-A02	Smart Switch 6, 15A with USB port and LED to indicate energy usage	46.40
AEOZW078-A	Heavy Duty Smart Switch, 90-260VAC, 40A, heavy-duty appliance switch with load monitoring, IP43 rated for outdoor applications	81.37
AEOZW121-A	RGBW LED Strip, 5M (16.5')	151.83
AEOZWA001-US	LED Bulb 6, Multi-White, 800 lumens	CALL
AEOZWA002-US	LED Bulb 6, Multi-Colour, 800 lumens	CALL

Sensors



AEOZW112-US



AEOZW100-A



AEOSDE010

AEOZW120	Door/Window Sensor Gen5	27.62
AEOZW112-US	Door/Window Sensor 6	35.94
AEOZW089-US	Recessed door/window contact	31.07
AEOZW100-A	Multisensor 6, Gen5, motion, temperature, humidity, light, UV, vibration	46.80
AEOSDE010	Recessor for Multisensor 6	11.76
AEOZW122-US	Water Sensor 6, built-in siren	45.06
AEOZW160	Water Sensor 6 Dock, adds wired power and sensor to ZW122-US	18.41

Network Devices

AEOZW117-A	Range Extender 6. Plug-in Z-Wave repeater, extend Z-Wave networks	24.13
AEOZW090-A	Z-Stick, Gen5	33.57



AEOZW117-A



AEOZW090-A

dōme

**Kick-ass Z-Wave devices, with
kick-ass pricing to match.**

Price. Support. Performance.

domeha.com | support@domeha.com | 773.794.1300

Simon says -
Lights on!

**ON/OFF
PLUG-IN
SWITCH**



The first ever Z-Wave rate trap.

MOUSER



Perimeter patrol.

DOOR/WINDOW SENSOR PRO



Caught Red Handed.
MOTION DETECTOR



A killer siren for your favorite hub.

SIREN



Dome is the premier home automation brand from Elexa Consumer Products Inc. offering high quality Z-Wave devices. Attention to detail, top-rated components and top-notch engineering make Dome products the smart choice for integrators and end users alike. Dome's line of Z-Wave products was created with one goal in mind: to provide superior quality home automation devices at an affordable price. Their versatile devices are designed to integrate flawlessly with other Z-Wave products, enabling homeowners to create a truly custom smart home experience. Dome's products have been tested to work reliably with SmartThings, Vera, HomeSeer, URC, Fibaro, Wink, and more.



Z-Wave Sensors

Add the Dome Leak Detector to your installations to prevent the next disaster!
-Battery powered and low-profile
-Flexible mounting
-External sensor probe optional.



The Dome Door/window sensors have some unique features that make this sensor special!
-Battery powered and low-profile
-Versatile applications with doors, windows, garage doors and even cabinets and drawers.

DOMDMWS1 Dome Leak Sensor 34.26

DOMDMWD1 Dome Door/window sensor 18.78

Detect presence and trigger events in every room with the Dome Motion sensor!
-Low profile and versatile mounting
-Battery powered
-Adjustable sensitivity
-Built in light sensor
-Extra wide 110° area of detection!



Be in the know with Dome's Siren sensor with unique sounds!
-Three volume levels with multiple sounds for non-critical event notifications.
-Battery powered and flexible mounting as well as low profile.
-Alert those nearby with visual AND audio alerts.

DOMDMMS1 Dome Motion sensor 30.90

DOMDMS01 Dome Siren 30.90

Z-Wave Range Extender

With the range extender, we can expand your Z-Wave network to ensure complete coverage of your network!
-Extends Z-Wave network coverage
-Built-in night lights and LED control
-Plugs directly in occupying only one side of the outlet
-Optional USB port allows for mounting on wall, window, or tabletop



DOMRange Dome Range Extender CALL

Z-Wave Water Valve Controller



Control your home's water autonomously with the Dome Water Valve Controller. With this amazing device, you can automate any quarter-turn valve in your house to provide a peace of mind that even the insurance companies appreciate. The best part of this device is that you do not need a plumber to install it! The valve installs on existing valves (up to 1-1/2") for ease of installation. This easy to install device only requires a screwdriver for installation.

DOMDMWV1 Water Valve Controller 68.68

Other Z-wave Devices



Automate every light and device in your house with the Dome Smart Plug. With this low profile device, you can control a single outlet and not obstruct your other receptacle. This Smart Plug will not only repeat the Z-wave signal but it will also read the amount of energy that your devices are using.

DOMDMOF1 Dome On/Off Smart Plug 30.84



With this one-of-a-kind device from Dome, you can humanely eliminate rodents with an electrical jolt. The Mouser from Dome can send you a notification should it encounter an unwanted guest. The device is battery operated and offers easy clean-up.

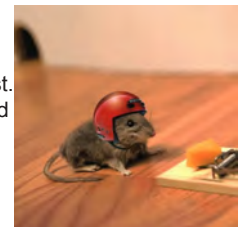

DOMDMMZ1 Dome Mouser 54.94

Z-Wave Do's and Don't's

- Always have at least one hardwired device near battery operated devices to help with range and communication. This can help with battery life as well as it reduces the need for the battery device to re-send signals.
- Be mindful of large metallic objects, like filing cabinets or ductwork, which can severely restrict RF range.
- If issues occur when learning in a device, go through an exclusion process and then try again.
- When learning in a secure-class device (door lock, garage door controller) wait at least one full minute after learning it in before you move the controller/lock.
- Keep in mind that Z-Wave is similar to Wi-Fi. There is a limited amount of bandwidth. The more communication you have going on, the greater the chance there is of getting a slow response or losing communications. This is especially true with sending an All On/Off command or locking/unlocking Z-Wave locks simultaneously.

- We do not recommend outdoor mounted Z-Wave Devices. Exterior walls can severely impede RF transmission, causing reliability issues in your Z-Wave network.
- Avoid exceeding more than 5,000 square feet. We can assist in finding a suitable solution for your larger installations.
- Please do not assume that a product is compatible with any given controller. Please check the manufacturer's list of compatible devices.
- Avoid placing devices more than 25-35 feet apart. This will vary depending on building construction.
- Avoid ganging together multiple Z-Wave devices into the same box. Z-Wave is meant to communicate at a distance.
- Avoid installing Z-Wave dimmers or switches in metal boxes. This will impede the Z-Wave transmission.



GUARDIAN™

BY ELEXA

I protect your home
from water damage.

FREE*

Contact your
insurance
provider for
discounts and
incentives
options!

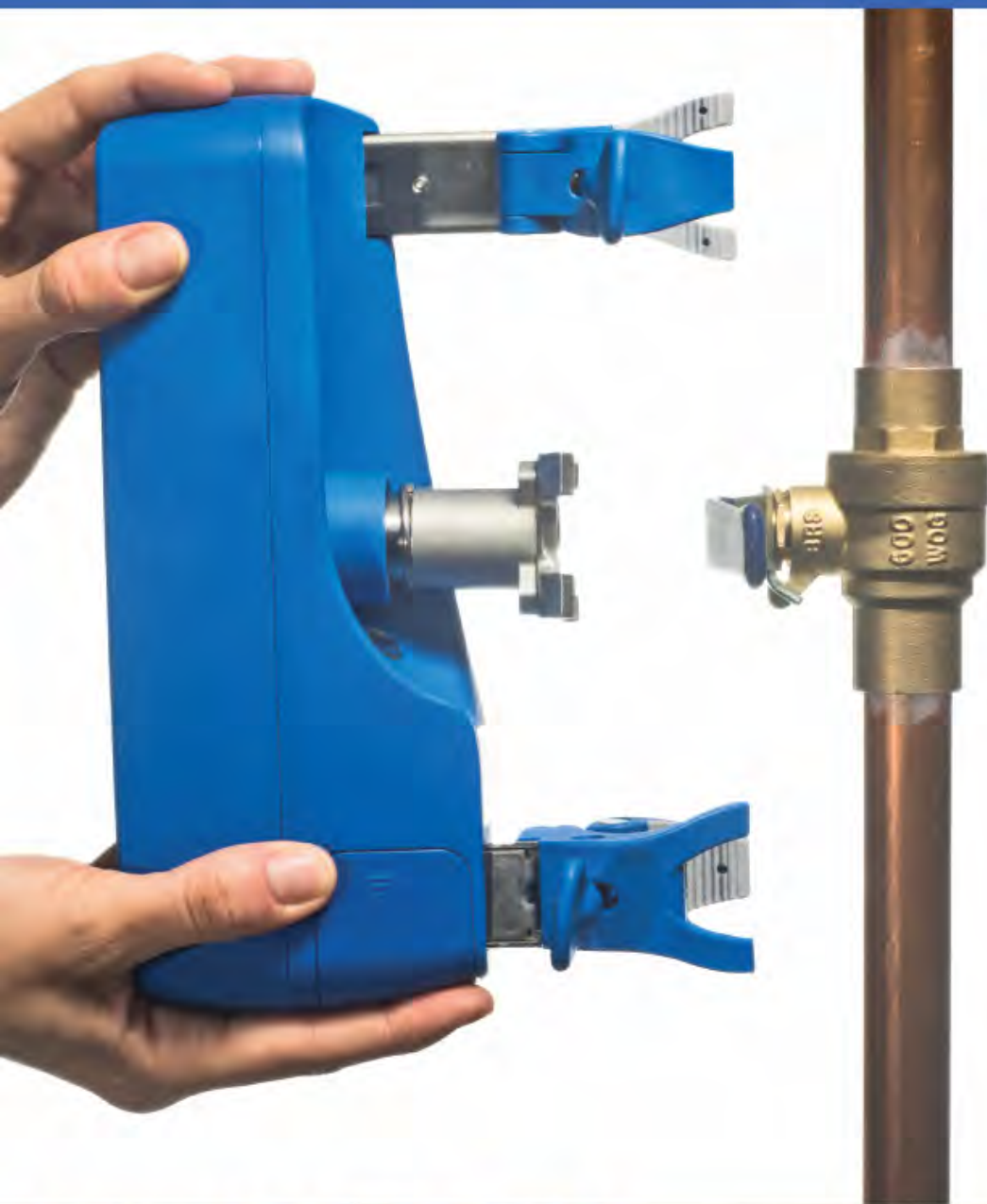

Completely Standalone

The Leak Detectors communicate directly with the Valve Controller, avoiding the need for hubs or other useless hardware.



No Tools Required

Guardian installs without any tools or professional help – configuration usually takes under ten minutes.



Off-line Functionality

Guardian will protect your home without internet connectivity. The internet is only required for initial setup, off-site control and notifications.



Extreme Long Range

Leak Detectors can be placed up to 1000' away from the Valve Controller, that's more than an entire city block.



Routine Self Tests

The Valve Controller will regularly check your valve to make sure it's not blocked during an emergency.



Battery Backup

An optional battery backup powers the Valve Controller for an extra twelve hours to protect your home during power outages.

GETGUARDIAN.COM
@GUARDIANBYELEXA

*Many insurance providers offer discounts and incentives on water mitigation systems. The Guardian Leak Prevention System, on average, pays for itself in two years. Discounts will continuously be applied for the life time of the product. Should your provider not offer discounts or incentives, visit our website for providers who participate.



Add Alexa Voice Control to Leviton Omni Systems

Using the HomeSeer HSHT-ZEE, we now have the ability to add Amazon Alexa voice control to Leviton Omni Systems*. The required components are a Leviton Omni System (LTe, IIe or Pro II), an HSHT-ZEE and an Amazon Echo or Echo Dot (1 or 2).

“Alexa, tell HomeSeer to set the security mode to arm away.”



With Alexa, you can control:

- **Lighting**
- **Thermostats**
- **Security**
- **Outputs**
- **Flags**
- **Buttons**
- **HomeSeer Events**
- **And More**

“Alexa, tell HomeSeer to set the living room heat to 72 degrees.”

*Plug-in required. Call for details.



HSHT-ZEE

The HomeTroller ZEE is an advanced home automation controller that's designed to simplify your life by integrating and automating the major systems of your home! Use it to monitor and control lighting, appliances, door locks, thermostats, window shades, water heaters, valves, and more!

- Z-Wave controller built-in
- Built-in web server for remote access
- Easy-to-use web interface allows easy access and control with any browser
- Compatible with Linux Plug-Ins (up to 5)
- Creates alerts, announcements and reminders by email and text message
- Includes calendar-based functions for easy scheduling
- Includes true 'trigger-based' automation with advanced conditional options
- Built-in power failure recovery feature runs events missed during outages when power is restored

HSHT-ZEE	Home Automation Controller w/Z-Wave	154.84
HSHT-SEL	Controller for Larger Installations	348.53
HSMS200	Z-Wave MultiSensor/Indicator	67.95
HSHT-S6	HomeTroller S6 Controller	750.30
HSZ-NET	Network Enabled Z-Wave Interface	120.72

Other HomeSeer products available, see page 18.

Z-Wave Sensors

HSMS-FS100+	Flex Sensor, perimeter water sensor/LED sensor. Sends Z-Wave signal when LED goes on/off	CALL
HSMS-DS100+	Small and sleek door/window sensor	26.19
HSMS-LS100+	Leak sensor with probe and cable	26.19
HSMS-MS100+	Motion sensor, battery or wired power	26.19
HSMS-WV100+075	3/4" water valve kit, includes valve and controller with manual buttons	199.79

*Also available in 1" and 1/4" sizes. Call for more information.



HSMS-MS100+



HSMS-LS100+



HSMS-FS100+

NORTEK
SECURITY & CONTROL

2GIG-PD300EMZ51	Plug-in lamp module, 300W, dimmable	29.51
2GIG-PS15EMZ5-1	Plug-in Appliance Module, 15A, relay	32.20
2GIG-WD500Z5-1	Decorator single-pole 500W neutral dimmer	32.20
2GIG-WS15Z5-1	Decorator single-pole neutral switch, 15A	32.20
2GIG-WO15EMZ5-1	Wall outlet, 15A, one side controlled	32.20
2GIG-WT00Z5-1	Z-Wave Transmitter for 3-ways	32.20
2GIG-WA105DBZ-1	105dB Z-Wave siren/strobe combo	40.28
2GIG-WF00Z-1	Smart water leak sensor	26.82
2GIG-LBR30Z-1	65W equivalent LED, 5000K dimmable Z-Wave flood light bulb	29.51
2GIG-LB65R6Z-1	65W equivalent LED, 2700K dimmable Z-Wave recessed light retrofit kit	32.20
2GIG-WA00Z-1	2-button Z-Wave battery powered transmitter for use with Z-Wave LED bulbs. Fits over existing switch to ensure bulbs are always available to the Z-Wave network	32.20

* Wall dimmer and switch are white, color trim kits are available in Almond, Black, Brown and Ivory. Call for details.

Worthington carries other products from Nortek.

Compatible with virtually any automatic garage door opener connected to a sectional garage door, installers only need to 'pair' the unit into a gateway, mount the unit, connect two wires and plug it in.



Providing both audible and visual warnings prior to door movement, the GD00Z-5 meets UL 325-2010 safety requirements. These built-in measures (in addition to the safety features that come with the garage door opener) make this a safe way to remotely open / close a garage door.

LGND00Z-5	Z-Wave garage door opener	74.65
-----------	---------------------------	-------



2GIG-LB60Z-1	60W equivalent LED, 2700K dimmable Z-Wave A19 bulb	13.43
--------------	----------------------------------------------------	-------

- Wirelessly control the bulb from anywhere (requires Z-Wave App for iOS or Android)
- Turn the bulb ON, OFF, or use its dimming features to adjust to 100 levels of brightness
- Acts as a wireless repeater to extend the Z-Wave mesh network to cover longer distances
- Integrates with other Z-Wave certified products from Linear and 2GIG by Linear

Z-Wave Locks

Kwikset, the leader in residential security, provides a smarter way to expand your smart home solution with a complete line of wireless enabled door locks. With a supporting Z-Wave system, you can control your lock from anywhere. Never worry about forgetting to lock your door again.

- Motorized locking enables true remote locking & unlocking
- Tapered deadbolt design permits misaligned doors to lock & unlock with ease
- Features SmartKey® Security
- 128-bit Advanced Encryption Standards (AES) Communication
- 30 user access code capacity
- Supported by 2GIG, Vera Control, Fibaro, SmartThings, HomeSeer, and more

SmartCode 914 Series Motorized Deadbolts

BD99140-*** Motorized deadbolt with full 10-button keypad 177.61

*** 001-Polished Brass, 002-Satin Nickel, 003-Venetian Bronze

SmartCode 916 Series Motorized Deadbolts

BD99160-*** Motorized deadbolt with touchscreen keypad 206.83

*** 001-Polished Brass, 002-Satin Nickel, 003-Venetian Bronze



SmartCode 910 TRL SmartCode 910 CNT SmartCode 912 Lever

SmartCode 910 Series Motorized Deadbolts

BD99100-*** Z-Wave Motorized deadbolt 137.39

*** Traditional, 026-Polished Brass, 005-Satin Nickel, 006-Venetian Bronze

*** Contemporary, 011-Satin Nickel, 012-Satin Chrome, 013-Polished Chrome, 014-Venetian Bronze

912 Series Motorized Lever Locks

BD99120-*** Z-Wave motorized lever lock 168.62

*** 005-Satin Nickel, 006-Venetian Bronze, 026-Polished Brass



Signature Series TRL

Your deadbolt just got smarter.

Control and monitor your lock from anywhere with discreetly integrated wireless technology. Available in both a traditional round and contemporary square design.

Signature Series Motorized Deadbolts

BD99100-06# Traditional round - no keypad 115.41

1-Polished Brass, 2-Satin Nickel, 3-Venetian Bronze

BD99100-06% Contemporary Square - no keypad 115.28

% 4-Satin Nickel, 5-Venetian Bronze



SmartCode 914

914 Series

- 10-button keypad vs 5-button on 910
- Smaller inside compartment with metal battery cover

916 Series

- 10-button touch keypad
- Smaller inside compartment with metal battery cover



SmartCode 916

SmartCode 914 Series Motorized Deadbolts

BD99140-*** Motorized deadbolt with full 10-button keypad 177.61

*** 001-Polished Brass, 002-Satin Nickel, 003-Venetian Bronze

SmartCode 916 Series Motorized Deadbolts

BD99160-*** Motorized deadbolt with touchscreen keypad 206.83

*** 001-Polished Brass, 002-Satin Nickel, 003-Venetian Bronze

Kwikset Non-RF Motorized Locks are available. Call for details.

New 888 Series Deadbolt



888 Series Deadbolt

SmartCode 888 is Kwikset's newest keypad electronic deadbolt. It has transitional styling, a 6-button keypad, and an industry-leading small, all-metal interior. It also uses the latest Z-Wave 500 chipset to connect with a Z-Wave home automation system.

- Z-Wave Plus
- Supports up to 30 user codes
- -40°F to 150°F temperature range
- Easy to replace batteries
- Re-key using SmartKey technology

BD98880-*** 6-button, motorized Z-Wave Plus deadbolt with all metal interior 120.84

*** 001-Polished Brass, 002-Satin Nickel, 003-Venetian Bronze

Coming Soon!



Obsidian

Obsidian

- 10-button keypad
- Low-profile
- Random number touch feature so fingerprints are everywhere

Convert

- Make any deadbolt to a motorized smart deadbolt



Convert

Worthington carries Baldwin locks. Give us a call today!

Looking for ZigBee Locks to Integrate with your Leviton Omni System? See page 90.

Yale Locks

- Push button or capacitive interfaces
- Indoor temperature range 5°F to 140°F
- Outdoor temperature range 5°F to 140°F
- Directly supported by 2GIG (v1.9 and later), Vera Control, and HomeSeer
- Support via the Leviton VRC0P (rev 3) Z-Wave interface with Leviton Security and Automation and ELK
- When using the Leviton VRC0P, it is recommended to use the Leviton VRUSB-1US USB stick (page XX) and the free Leviton RFinstaller software to set up and configure the Z-Wave network
- Yale deadbolts come standard with a K Keyway. Optional keyways available.

Looking for ZigBee? See page 90.



YALL210ZW605



YALL200ZW0BP

Z-Wave Communicating Entry Lever Sets

YALL220ZW+	Motorized Z-Wave entry lever set with capacitive touch keypad	206.08
YALL210ZW+	Motorized Z-Wave entry lever set with pinpad	187.35

+605-Bright Brass, 0BP-Oil Rubbed Bronze, or 619-Satin Nickel



Norwood



Marina



McClure



Academy



Milan



Cascade

Lever Options for Yale Lever Locks (Norwood Is Standard)

YALYR05D8+*	Alternate levers for Yale entry lever sets	19.73
-------------	--------------------------------------------	-------

+ 2-Cascade, 3-Milan, 4-Marina, 5-McClure, 7-Academy, 8-Norwood
* 3-Polished Brass, N-Satin Nickel, K-Oil Rubbed Bronze

Yale Commercial Grade Locks



- ANSI/BMHA Grade 1
- Weather Resistant Gasket
- 9V Battery Backup

Ideal for employee entrances, delivery or back entry.



YALNTB610ZW2626	Motorized Z-Wave commercial (Grade 1) lever with pinpad - Satin Chrome	374.70
YALNTB620ZW2626	Motorized Z-Wave commercial (Grade 1) lever with capacitive touch keypad - Satin Chrome	387.19

Z-Wave Communicating Deadbolts

YALD226ZW2+	Backlit capacitive keypad Z-Wave deadbolt with motorized deadbolt	206.08
YALD110ZW+	Backlit push button, key free Z-Wave lock with motorized deadbolt. B1L Series.	137.39
YALYRD120ZW+	Backlit touchscreen, key free Z-Wave lock with motorized deadbolt. T1L Series.	174.86
YALD216ZW2+	Backlit push button Z-Wave lock with motorized deadbolt	168.62
YALD256ZW2+	Backlit touchscreen Z-Wave lock with motorized deadbolt and no cylinder	206.08

+605-Bright Brass, 0BP-Oil Rubbed Bronze, or 619-Satin Nickel



YALD216ZW20BP



YALD262ZW2619



YALYRD120ZW605



YALD256ZW2+



YALD446ZW2619



Bluetooth Communicating Deadbolt with Z-Wave

YALD446ZW2+	Motorized Bluetooth deadbolt with capacitive touch keypad. Also contains Z-Wave radio for use with automation systems.	206.08
-------------	------------------------------------------------------------------------------------------------------------------------	--------

+605-Bright Brass, 0BP-Oil Rubbed Bronze, or 619-Satin Nickel

Forget carrying around keys; lock and unlock your home with your smartphone. Share digital keys with friends and family, view access history and customize lock settings and pin codes, all from your Yale Assure app.

The Assure Lock with Bluetooth also includes a Z-Wave module. Enjoy the best of both worlds, key free unlocking at the door from Bluetooth and advanced smart home features and remote access with your Z-Wave controller.

Non-Communicating Locks

YALD226NR+	Motorized deadbolt with touch keypad	149.88
YALD216NR+	Motorized deadbolt with pinpad	118.66
YALD256NR+	Slim motorized deadbolt with no cylinder	149.88

+605-Bright Brass, 0BP-Oil Rubbed Bronze, or 619-Satin Nickel

Z-Wave Locks

Deadbolts		
SCHBE469CAM*	Camelot Z-Wave Motorized Touchscreen Deadbolt: *605-Bright Brass, 619-Satin Nickel	180.63
SCHBE469CAM716	Camelot Z-Wave Motorized Touchscreen Deadbolt, Aged Bronze	180.63
SCHBE469CAM622	Camelot Z-Wave Motorized Touchscreen Deadbolt, Black	180.63
SCHBE469CEN*	Century Z-Wave Motorized Touchscreen Deadbolt: *619-Satin Nickel, 625-Bright Chrome, 626-Satin Chrome	174.55
SCHBE469CEN716	Century Z-Wave Motorized Touchscreen Deadbolt, Aged Bronze	180.63
SCHBE469CEN622	Century Z-Wave Motorized Touchscreen Deadbolt, Black	176.57

- Direct support by 2GIG, Vera Control, Fibaro, SmartThings, and HomeSeer
- Support via the Leviton VRCOP (rev 3) Z-Wave interface with Leviton Omni and ELK
- When using the Leviton VRCOP, it is recommended to use the Leviton VRUSB-1US USB stick (page 17) and the free Leviton RF Installer Tool software to set up and configure the Z-Wave network



Camelot

Century

Budget Deadbolts

By removing the siren and lighted touchscreen, Schlage is able to offer these deadbolts at a reduced price. These deadbolts are dealer-exclusive!

SCHBE468CAM*	Camelot Z-Wave Motorized Touchscreen Deadbolt: *505-Bright Brass, 619-Satin Nickel, 625-Bright Chrome, 716-Aged Bronze	154.25
SCHBE468CEN*	Century Z-Wave Motorized Touchscreen Deadbolt: *619-Satin Nickel, 625-Bright Chrome, 626-Satin Chrome, 716-Aged Bronze	156.27



Century

Lever Set

Camelot

Entry Lever Set

SCHFE599*	Z-Wave Lever Set (with clutch): *505-Bright Brass, 716-Aged Bronze	168.45
SCHFE599619	Z-Wave Lever Set (with clutch), Satin Nickel	170.49

Deadbolt with Matching Lever (Specify Left or Right Handed)

SCHFE469CAM*	Camelot Z-Wave Motorized Touchscreen Deadbolt with Matching Lever Set (ACC - Accent Style Levers)	263.85
SCHFE469CEN+	Century Z-Wave Motorized Touchscreen Deadbolt with Matching Lever Set (MER - Merano Style Levers)	263.85

*605-Bright Brass, 619-Satin Nickel, 716-Aged Bronze; +619-Satin Nickel, 625-Bright Chrome, 626-Satin Chrome, 716-Aged Bronze

Z-Wave Locks



The Schlage Sense Smart deadbolt is compatible with Bluetooth technology - which allows you to unlock your door using your iPhone®, iPad® or any other smartphone or tablet.

Add the SCHBR400 WiFi Adapter (up to 2 locks per adapter) to allow control of your Schlage Sense locks from anywhere using iOS or Android phones and tablets.

SCHBE479CAM619	Camelot style Apple HomeKit-compatible motorized Bluetooth deadbolt - Satin Nickel	194.84
SCHBE479CAM716	Camelot style Apple HomeKit compatible motorized Bluetooth deadbolt - Aged Bronze	198.90
SCHBE479CEN619	Century style Apple HomeKit-compatible motorized Bluetooth deadbolt - Satin Nickel	194.84
SCHBE479CEN622	Century style Apple HomeKit-compatible motorized Bluetooth deadbolt - Matte Black	205.00
SCHBR400	WiFi Adapter for Bluetooth Locks	59.02



Camelot

Century

Create schedules/send lock codes. Over the air firmware updates.

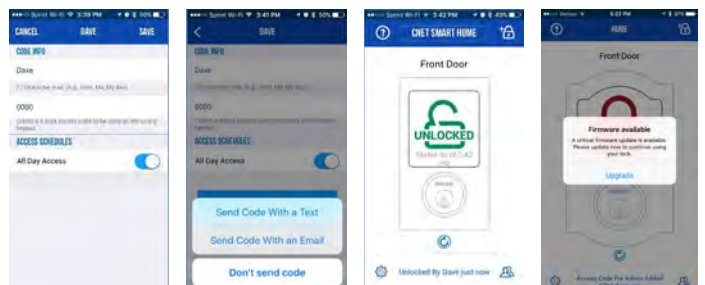



AUGAB02M02G02

Your Smart Home Starts at the Front Door



August Pro Locks Work With:

- Leviton Omni (LTe, Ile, Pro II) - see Pages 84-103
- Vera (VeraEdge, VeraPLUS) - see Page 18
- Fibaro (HomeCenter Lite, Home Center 2) - see Page 10
- HomeSeer (HT-ZEE, HT-SEL, and more) - see Page 23
- SmartThings - see Page 16
- Zipato (Zipatile, Zipamicro) - see Page 13
- 2GIG (GC2, GC3) - see Pages 113-116
- Harmony Home Hub Extender - see Page 41

August Smart Lock works with the free August app to create keys, grant access, view the activity log, and more. Available for Android™ and iOS®.

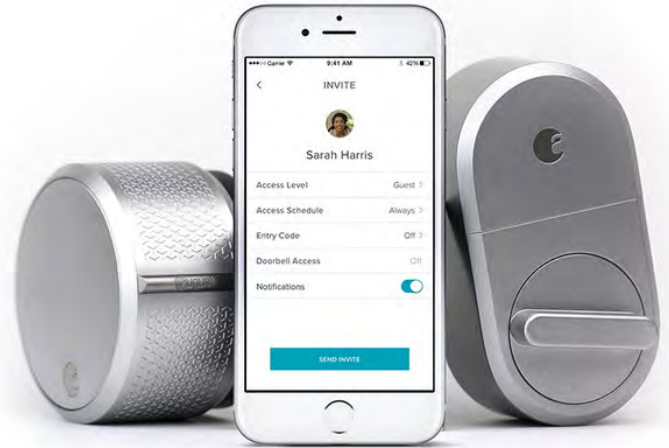

AUGSL03M03S03

AUGSL04M01S04

- Works with wired doorbells
- 2 way talk/ 1 way camera
- Lock/Unlock your August Smart Lock from anywhere
- Pro Lock supports Bluetooth, Z-Wave and Home Kit
- Does not affect outer hardware
- Unlock when phone is near lock
- Doorbell/Intercom
- Optional Keypad
- Works with Nest
- Harmony Remote compatible

AUGSL04M01S04	Smart Lock - Silver	117.60
AUGSL04M01G04	Smart Lock - Dark Grey	117.60
AUGSL03M03S03	Smart Lock Pro - Silver	165.60
AUGSL03M03G03	Smart Lock Pro - Dark Grey	165.60
AUGAB01M01S01	Doorbell Cam - Silver	165.11
AUGAB01M01G01	Doorbell Cam - Dark Grey	165.11
AUGAB02M02S02	Doorbell Cam 2.0 - Silver	166.80
AUGAB02M02G02	Doorbell Cam 2.0 - Dark Grey	166.80
AUGAC02	Connect Bridge - Required for remote access/control	66.04
AUGAK01M01G01	Smart Keypad	66.04

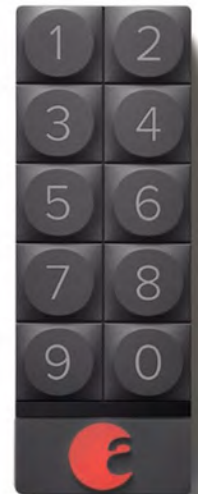

AUGAK01M01G01

zipato®



ZIPATILE 2

ALL IN ONE HOME ASSISTANT



SECURITY ALARM

- Presence sensor
- Noise sensor
- Shock sensor
- Touch keypad
- Alarm siren multi-sound
- Photo and video messages
- 24/7 central monitoring
- Remote control with smartphone



INTERCOM

- SIP server client
- Door phone control
- Conference calls
- Video calls
- Dual-network IP connectivity
- Remote control with smartphone



HOME AUTOMATION

- Remote control with smartphone
- Rule creator online
- Scene manager
- Room manager
- Z-Wave ZIGbee, Nest, Philips Hue, Sonos, Bluetooth, Homekit...



WALL PANEL

- Room temperature
- Room illuminance
- Room humidity
- Weather forecast
- Sticky notes
- News stream
- Photo frame
- Email, Skype, browser
- Multimedia control
- Scene controller 6 buttons



THERMOSTAT

- Gas/floor heating
- Temperature meter
- Exterior temperature meter
- Air condition control
- Remote control with smartphone



ELDERLY CARE

- Motion sensor
- Noise detector
- Automatic check calls
- Panic button with auto call
- Sound reminders
- Video and voice calls



IP CAMERA

- 2 megapixels
- Live video stream H.264
- Motion and scheduled recordings
- Remote control with smartphone



Z-Wave Water Flow Meter

FRTFMINLC075R10	3/4" Brass Series, Lead Free	181.20
FRTFMINLC100R10	1" Brass Series, Lead Free	252.11



FRTFMINLC***R10

The flow meter keeps track of water usage and reports the total cumulative gallons used. Great for detecting leaks and unwanted usage. The flow meter also reports if water is flowing or not. Also detects small versus large flow.

Z-Wave Input / Output Module

FRTMIMOLITEUS	1 Input, 1 Form-C Output Z-Wave Module	47.76
FRTMIMO2US	2 Input, 2 Form-C Output Z-Wave Module	63.67



FRTMIMOLITEUS



FRTMIMO2US

**Looking to convert non-Z-Wave devices to Z-Wave?
Need a Z-Wave controllable contact closure?**

The MIMO and MIMOLite are the answer to your needs. MIMOLite has 1 input and 1 output while the MIMO has 2 inputs and 2 outputs.

Z-Wave Water Sensors

FRTFTS05US	Flood and temperature sensor (Gen 3). Pair with a WV-01 to turn off water. Requires 2 AA batteries.	39.81
FRTFTS05PUS	Flood and temperature sensor (Gen 3) with probe and permanent power (USB). Pair with a WV-01 to turn off water. Requires 2 AA batteries. Temperature sensing at probe.	50.95



FRTFTS05US



FRTFTS05PUS

Z-Wave Sounders



FRTSSA1US

FRTSSA1/2US

- 117dB siren for auditory notification
- 5 LED's for visual notification
- LED's and siren can be controlled via standard lighting level commands
- Choose Red or Clear lens
- Use with sensors and valves for alarm



FRTSSA2US

FRTSSA1US	Z-Wave siren/strobe, 12VDC with 9V battery backup. Use with FTS05US or FTS05PUS. Clear lens.	35.61
FRTSSA2US	Z-Wave siren/strobe, 12VDC with 9V battery backup. Use with FTS05US or FTS05PUS. Red lens.	35.61

Z-Wave Controlled Water Valves

Choose Indoor or Outdoor

Indoor Actuator

FRTWV01ACTUS	Motorized water valve actuator. Includes actuator and wired water sensor. Use with FTS05(P)US or with a gateway to turn water off/on. Requires ball valve.	281.02
--------------	------------------------------------------------------------------------------------------------------------------------------------------------------------	--------

Outdoor Actuator w/Cable to Indoor Control Panel

FRTWV02ACT25US	Motorized water valve actuator. Includes actuator, wired water sensor and cable connected to indoor control panel. Use with FTS05(P)US or with a gateway to turn water off/on. Requires ball valve. 25' cable.	311.00
FRTWV02ACT50US	Outdoor actuator w/50' cable.	322.24
FRTWV02ACT75US	Outdoor actuator w/75' cable.	333.48



FRTWV01ACTUS



FRTWV02ACT**US

- Choose ball valve size

- Choose cable length (25', 50', 75')
- Choose ball valve size

Choose Water Valve Size

FRTBVALVE***



- Choose ball valve size
- 3/4"
- 1"
- 1-1/4"
- Attach to Indoor or Outdoor Actuator

FRTBVALVE075	3/4" Ball Valve for use with FortrezZ WV01ACTUS Indoor Actuator and WV02ACT**US Outdoor Actuators	37.47
FRTBVALVE100	1" Ball Valve for use with FortrezZ WV01ACTUS Indoor Actuator and WV02ACT**US Outdoor Actuators	47.46
FRTBVALVE125	1-1/4" Ball Valve for use with FortrezZ WV01ACTUS Indoor Actuator and WV02ACT**US Outdoor Actuators	81.18

Connect Z-Wave

FortrezZ Z-Wave water valve units can be paired with FortrezZ Water Sensors (FTS05US or FTS05PUS) to create a leak shut off system. You can also use a Z-Wave controller to pair water sensors, water valves, flow meters and sounders together to create a complete water monitoring solution.

Questions? Give us a call today!



OCPad



OCPad is a hardware platform based on a robust Octa-core processor. It supports Android system, and equipped with a rich peripheral interfaces. This platform offers the possibility to retrofit traditional appliances with intelligent features, therefore to enhance the products' value. Moreover, with customized firmware, it provides convenient user interface for effective human-computer interaction, which is a must feature for IoT system. To simplify development process, and accelerate the product marketing schedule, OCPad is developer's first also the best choice.

Feature:

- 8-inch Multipoint capacitive touch LCD (IPS optional)
- Built-in Z-Wave dongle (other protocols optional)

Shutter Panel

C521 touch panel is ideal for controlling venetian blinds, roller shutter motors, shades and sunscreens etc
 Motor Type: Single-phase AC motor
 Support Automatic Calibration and Manual Calibration



MH-C521

Dimmer Panel

Support leading edge or trailing edge dimming type
 With energy metering function
 2-wire or 3-wire connection



MH-DT511

Touch Panel Switch

Elegant designed glass panel with capacitive touch buttons (WHITE/ BLACK/ GOLDEN or other customized color)
 1-gang, 2-gang, 3-gang models



MH-S513

PM2.5 Monitor

Monitor PM2.5 value in air with high accuracy
 Built in with Temperature & Humidity sensor



MH10-PM2.5

CO2 Monitor

Monitor CO2 concentration in air with high accuracy
 Built in with Temperature & Humidity sensor



MH9-CO2

Heating Thermostat

Applied to control floor heating or baseboard system
 GFCI (leakage protection), Floor overheating protection, ETL, FCC Certification



MH4

Programmable Thermostat

Applied to control heat pump or regular AC system (up to 3H/2C)
 Output: 2-stage cooling, 3-stage heating, fan(on/auto)



MH6-HP-US

Micro Switch/Dimmer

Embedded module for on/off switching or light dimming
 Suit for any kind of switch panel (Toggle switch, Touch buttons, Momentary buttons)



MCOHome Technology Co., Ltd

Email: support@mcohome.com

http://www.mcohome.com



SCHTZEMT524

Trane (sold through sister company Schlage for the Nexia system)

- Supports conventional single and multistage systems as well as heat pumps
- Supports dual fuel systems (Rh and Rc terminals)
- A 24VAC common connection is required



SCHTZEMT524	Trane Z-Wave thermostat, single, multistage, or heat pump, common required	89.93
SCHXL624	Trane Z-Wave programmable thermostat	147.38
SCHTEMPSENSOR	Indoor Remote Temperature Sensor for TZEMT524 and XL624	24.98

Residential Control Technologies

- Supports conventional single and multistage systems as well as heat pumps
- Supports dual fuel systems (Rh and Rc terminals)
- A 24VAC common connection is required
- Remote control of energy savings mode as well as set points and mode



RCSTZ45	RCS Z-Wave thermostat, single, multistage, or heat pump, common required	139.58
RCSTBZ48	RCS Z-Wave thermostat, single, multistage, or heat pump, can run on batteries	139.58
RCSRTS3	Flush remote temperature sensor for RCSTZ45	23.42
RCSRTS4	Surface remote temperature sensor for RCSTZ45	23.42

Radio Thermostat Corporation of America

- Touchscreen for easy control of HVAC
- Supports conventional single and multistage systems as well as heat pumps
- Supports dual fuel systems (Rh and Rc terminals)
- Can run off of 4x "AAA" batteries, a 24VAC common connection is not required



RADCT32B	Z-Wave thermostat, single, multistage, or heat pump, battery option	83.90
RADCT101	Z-Wave thermostat, 2 stage heat/2 stage cool with Heat Pump and PTAC support	72.37
RADCT110RT-S	Z-Wave thermostat, 2 stage heat/2 stage cool with Heat Pump	91.09
RADCT110RT-P	Same as above with push terminals instead of screw terminals	92.10
RADCT100PLUS	Z-Wave touchscreen thermostat, 2 stage heat/2stage cool heat pump, battery	80.51
RADCT80	Z-Wave thermostat, requires RADZWAVE300	114.79
RADRTZW-01-300	Z-Wave U-Snap module for RADCT80 (required for Z-Wave control)	18.45
RADRTMV-01	Wi-Fi U-Snap module for RADCT80 (required for optional Wi-Fi control)	38.23

Tech Tip: Confirm thermostat compatibility with your Z-Wave controller before ordering



RCSTZ45



RADCT32B



RADCT110RT*

Stelpro 120V / 240V Z-Wave Thermostat

The Stelpro thermostat for the smart home is the first ever Z-Wave line voltage thermostat in North America. Stelpro thermostats can easily be integrated into a Z-Wave network, allowing you to adjust the temperature in rooms of your home from a distance. The Z-Wave technology also allows you to activate scenes, setting in motion several actions such as adjusting the temperature and lighting, activation of safety and entertainment systems and more.



STESTZW402WB+	120VAC / 240VAC Z-Wave Thermostat	71.94
---------------	-----------------------------------	-------

New Z-Wave Thermostat Options from MCO Home



MCOMH6-HP-US



MCOMH4-US

MCOMH4-US	110V/220V Z-Wave thermostat with floor probe	63.84
MCOMH4PROBE	Spare probe for MH4-US thermostat	3.04
MCOMH6-HP-US	24VAC Z-Wave thermostat	53.20
MCOMH8-FC-US	Fan coil Z-Wave thermostat	48.64
MCOMH9-CO2-WD	Z-Wave enabled CO2 detector, displays time, temp and humidity	76.00

Worthington Distribution now carries MCO Home thermostats and accessories. MCO Home offers attractive thermostats at an attractive price. Unique to MCO Home's lineup is a thermostat that supports in-floor heating with a probe. Another item you won't easily find is a fan coil thermostat. Also available is a Z-Wave CO2 detector with temp and humidity.



The **FIBARO** is a complete home control and automation solution that delivers peace-of-mind and comfort through a network of cooperating sensors, modules and devices.



Devices management



Plugins



Security



Scenes



Notifications



Climate



Cameras



Multimedia

Switches

JAS14318	Z-Wave Plus Decorator Style Switch, 960W Incandescent or 15A Resistive, White and Light Almond	31.24
JAS45740	Toggle Style Switch, 960W Incandescent or 15A Resistive, White	30.93
JAS45760	Toggle Style Switch, 960W Incandescent or 15A Resistive, Light Almond	30.93

Add-On for 3-Way Circuits

JAS45710	In-Wall Decorator Style Add-On, use with 45709 and 45712, White and Light Almond	12.18
JAS45741	In-Wall Toggle Style Add-On, use with 45740 and 45742, White	11.87
JAS45761	In-Wall Toggle Style Add-On, use with 45760 and 45762, Light Almond	11.87

Color Change Kits

JAS1394*	Color change kit for dimmers/switches, decorator	1.45
JAS3535+	Color change kit for dimmers/switches, decorator	1.45
*0-Black dimmer, 1-Black switch/add-on, 3-Brown dimmer, 4-Brown switch/add-on, 5-Ivory dimmer, 6-Ivory switch/add-on		
+8-Light Almond-dimmer, 9-Light Almond switch/add-on		

Dimmers

JAS14321	Z-Wave Plus Decorator Style Dimmer, 600W Incandescent, 150W CFL/LED, White and Light Almond	33.76
JAS45715	Decorator Style Dimmer, 1000W Incandescent only, White and Light Almond	36.26
JAS45742	Toggle Style Dimmer, 600W Incandescent, 150W CFL/LED, White	33.45
JAS45762	Toggle Style Dimmer, 600W Incandescent, 150W CFL/LED, Light Almond	33.45



JAS14321



JAS45742



JAS45762

Please check compatibility when dimming LED and CFL bulbs.

Plug-Ins and Other Devices

JAS45705	Decorator Style Duplex Receptacle, 15A, White	29.96
JAS45734	Energy Monitoring Outdoor Contactor, 40AMP-240V for large loads	119.78
JAS32563	Hinge Pin Door Sensor, up to 5/16" diameter	37.59
JAS45704	Outdoor Plug-In Appliance Module, 15A Resistive, 960W Incandescent, Black	31.52
JAS35931	LED Bulb, 60W equivalent, 2700K color temp.	22.32
JAS14287	Z-Wave Plus Fan Speed Controller	36.86

** Fan must be set on High at the "Pull Chain" **

JAS28170	Z-Wave Plus Plug-In Lamp Module, 300W Incandescent, 100W CFL/LED, White	23.84
JAS28166	Same as above but single outlet	22.27
JAS28172	Z-Wave Plus Plug-In Appliance Module, 15A Resistive, 960W Incandescent, White	21.89
JAS28168	Same as above but single outlet	20.32
JAS24770	Z-Wave Plus In-Wall Motion Sensor Switch	35.60
JAS26932	Z-Wave Plus In-Wall Motion Sensor Dimmer	38.82



JAS28166



JAS45704



JAS32563



JAS24770 / JAS26932



The DB100Z and the FASMOKECO allow you to monitor your doorbell button and smoke/carbon monoxide.

SCHFASMOKECO	Z-Wave Smoke/CO Detector	44.96
SCHDB100Z	Z-Wave Doorbell Sensor	43.72



SCHDB100Z



SCHFASMOKECO

Is the driveway covered?

We have sensors for the driveway, backyard, porch, outbuildings and more...



DCPA-2500

- Wireless vehicle sensing probe
- 1/2 mile wireless range from sensor to receiver
- Easy installation in just minutes
- Avoid trenching all the way to the house
- Long battery life
- Multiple relay outputs can be connected to other control panels
- Monitor up to 4 different zones

DCMA-2500

- Wireless motion detector
- 1/2 mile wireless range
- Detects people and vehicles



BBT-2500

- Solar Powered Wireless Breakbeam
- 1/2 mile wireless range
- Detects people and vehicles
- 300 ft detection range
- No trenching
- No wiring
- Easy installation

DATM

Dakota Alert[®]

WIRELESS SECURITY EQUIPMENT

www.DakotaAlert.com • 605.356.2772

Bitwise by Leviton

BitWise

- Controls A/V components
- Pre-designed templates make it simple to create stunning user interfaces
- Free iOS and Android apps
- Optional handheld remote
- Integration with Omni controllers
- Great for: Residential, commercial, conference rooms, classrooms, sports bars and more!



Create custom interfaces for home theater control systems. Make your jobs stand out!



Add-On Hardware and Accessories

Controllers



Leviton's network-enabled controllers are the heart of every BitWise Controls installation. These devices provide the intelligence and connectivity to control virtually any TV, Blu-ray, AV receiver, projector, and other gear. Each BitWise system is comprised of one or more controllers, which allow other systems in your home to interact with one another. Your system can scale from a single room to an entire home or building. BitWise controls can integrate with your favorite Leviton Omni controller for control of security, lighting, HVAC, shades, and more.

Hardwired remotes are a great solution for users that may not be familiar with or prefer not to use an iPad. This is also a great backup tool in case your phone or tablet has a low battery or goes missing during the "big game!"

BITBWBC1	BC1 Controller, 8 IR ports, 4 GPIO, 4 relays, 1 IR input	928.66
BITBWBC2	BC2 Controller, 4 IR ports, 2 RS-232, 2 GPIO, 2 relays	592.93
BITBWBC4	BC4 Controller, 4 IR ports, 1 RS-232, 1 GPIO	329.14

BITBWIRL	USB IR learner. Great labor saving tool. Learn IR codes from existing remote controls.	149.88
BITBWRMT	RF hard-button remote control. Requires BITBWRRR wireless receiver.	95.91
BITBWRRR	RF receiver for hard-button remote	59.94
BITBWIRI	IR to RS232 receiver module	89.33
BITBWEAR	Rack ears for BC2 controller	38.67
BITEN928	IR emitter single head, each	9.32

Project Editor Software

Project Editor Software is FREE software used by professional installers to create and manage project files for BitWise hardware installations. Simply drag and drop and pull-down menus.

Project Editor permits customization for iOS, Android, and the Leviton OmniTouch 7 touchscreen. Prefabricated templates can save hours of initial labor, see page 91 for more details.

Custom Programming

Need a Bitwise solution but don't have the time to learn something new? Let us help!

Our trained and experienced team is here to back you up with pre-programmed systems. Just give us all the details of the job and how you need the system to operate and we will ship it to you configured and ready to install.



Barry Hampe
BitWise Expert

Call Barry at Worthington today!

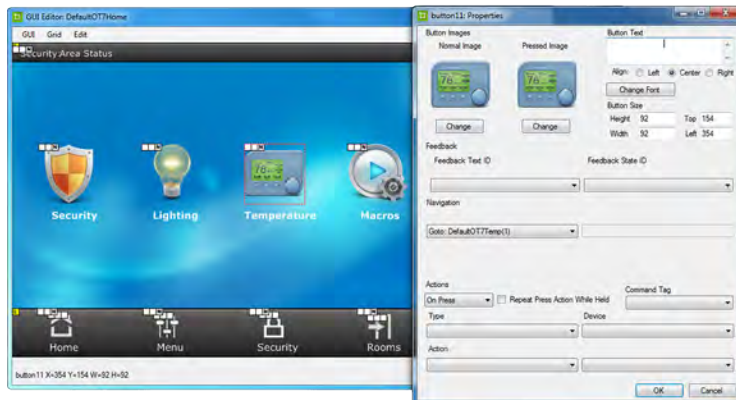

Project Editor Software

iTach Flex™ Family of Products

iTach Flex gives you the most flexible control solution on the market -

- Choose the network interface which matches your wiring
- Select the cable which matches your device

If the installation changes, just change the cable!



GCFLEX-IP/IP-P

GCFLEX-WIFI



GCFLC-SL-232

GCFLC-SL-485

GCFLC-RS

GCFLEX-IP	Wired Flex network interface	77.90
GCFLEX-IP-P	PoE Flex network interface	90.89
GCFLEX-WIFI	Wi-Fi Flex network interface	90.89
GCFLC-SL-232	Flex Link RS232 serial cable	19.45
GCFLC-SL-MJ	Flex Link RS232 mini-jack serial cable	19.45
GCFLC-SL-485	Flex Link RS485 serial cable	25.94
GCFLC-RS	Flex Link relay and sensor cable	51.92
GCFLC-3E	Flex Link three IR emitter cable	6.46
GCFLC-2E1B	Flex Link two IR emitter one IR blaster cable	12.30
GCFLC-BL	Flex Link IR blaster cable	9.70
GCFLC-T3	Flex Link tri-port cable	3.21

Automation Solutions with Fibaro



FIBARO
Home intelligence

Add home theater control to your Fibaro automation products with Global Cache

Looking for a simple and convenient way to combine home theater control with top-of-the-line home automation? Use a Fibaro Home Center 2 with their Global Caché plug-in for iTach modules. The setup and integration is fast and easy, plus your customers will love Fibaro's intuitive control interface.

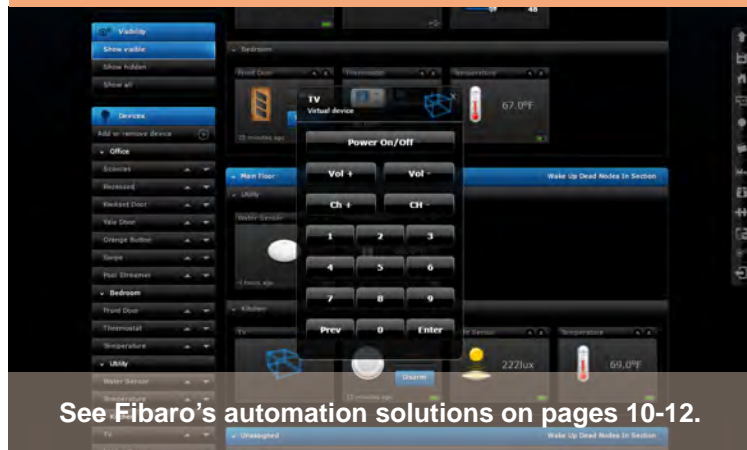

See Fibaro's automation solutions on pages 10-12.

Control Tower - Cloud-Based IR Library



Tired of scouring the web for IR codes?
Global Caché's Control Tower is the answer.
Register for free at irdb.globalcache.com

Features/Benefits:

- World's first cloud-based IR database.
- Complete database of over 200,000 IR codes.
- Available to all Global Caché hardware users.
- Easy identification and download of almost all IR code sets in use.
- Available in HEX and Global Caché formats.

iTach (non-Flex) Modules

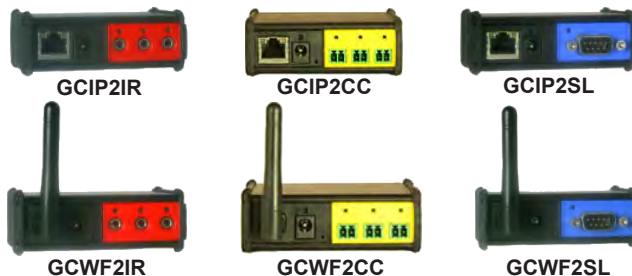

GCWF2IR	Wireless IR network interface	109.91
GCIP2IR	Wired IR network interface	91.18
GCIP2IR-P	PoE IR network interface	117.41
GCWF2SL	Wireless serial interface	109.91
GCIP2SL	Wired serial interface	91.18
GCIP2SL-P	PoE serial interface	117.41
GCWF2CC	Wireless contact-closure interface	109.91
GCIP2CC	Wired contact-closure interface	91.18
GCIP2CC-P	PoE contact-closure interface	117.41

iTach Sensors and Accessories

GCIT-SV1	"Video out" sensor	41.94
GCIT-SP1	AC/DC voltage sensor	29.95
GCIT-SC1	Contact-closure sensor	26.95
GCG-IR-E	Additional IR emitter	3.21
GC-CGX	Global Cache to Xantech conversion cable	29.95
GC-CXG	Xantech to Global Cache conversion cable	29.95

Other Global Caché Products



Worthington Distribution carries Global Caché's full product range, including the GC-100 series of network adaptors. For sales information on products not shown on this page please contact us at (800) 282-8864 or email us sales@worthdist.com.

Ring is on a mission to reduce crime in neighborhoods. With affordable solutions that work on any home, Ring is committed to offering smart security that's accessible to everyone. Ring lets you stop crime before it happens. Because with Ring, you're always home! Ring lets you monitor every corner of your property. With a Video Doorbell at your door and Spotlight Cams around the house, you can create a Ring of Security around your entire home.



Ring Doorbells

The Ring Video Doorbell is the perfect solution for any home and any budget. Armed with HD video, two-way talk and instant mobile alerts, you can answer the door and monitor your home from anywhere.

	Ring Doorbell 2	Ring Doorbell Elite	Ring Doorbell Pro
Power Requirements	8-24VAC or Battery	POE	16-24VAC
Finishes	Includes two faceplates: Satin Nickel, Venetian	Includes four faceplates: Satin Nickel, Pearl White, Venetian, Satin Black	Includes four faceplates: Satin Nickel, Satin Black, Dark Bronze, Satin White
Video Resolution	1080P	1080P	1080P
Compatible Networks	2.4 GHz 802.11 b/g/n	2.4 GHz or 5.0 GHz 802.11 b/g/n	2.4 GHz or 5.0 GHz (Channels 11-13) 802.11 b/g/n



Satin Black



Satin Nickel



Dark Bronze



Satin White

RIN8VR1S7-0EN0	Ring Video Doorbell 2	174.99
RIN8VR1E7-0EN0	Ring Video Doorbell Elite	380.00
RIN8VR1P6-0EN0	Ring Video Doorbell Pro	185.00



Doorbell 2
RIN8VR1S7-0EN0



Doorbell Elite
RIN8VR1E7-0EN0



Doorbell Pro
RIN8VR1P6-0EN0

Ring Doorbell Chimes

Connect the Ring Chime to all of your Ring devices, and get notifications anywhere in your home. With the Chime Pro, you'll get a built-in Wi-Fi extender and indoor Chime for your devices.

RIN8AC1S5-0EN0	Ring Chime	28.10
RIN8AC1P6-0EN0	Ring Chime Pro	40.00



RIN8AC1S5-0EN0

- Multi tone alerts
- Volume Control
- Do Not Disturb mode
- Chime Pro will boost Wi-Fi signal!



RIN8AC1P6-0EN0

Ring Solar Panel



RIN8ASPS7-BEN0

- Weather resistant design
- Adjustable mounting bracket for versatile installation
- Includes a tool kit and USB cable



RIN8ASPS7-WEN0

RIN8ASPS7-BEN0	Solar Panel - Black	34.00
RIN8ASPS7-WEN0	Solar Panel - White	34.00

Connect the Solar Panel to Stick Up Cam (Battery Operated) to get non-stop power, and you'll never need to charge your battery.

Ring Spotlight Cameras

HD camera with two-way talk and spotlights, for security anywhere you need it. With 1080P video, and wide-angle camera lens, you can keep up to date with events all around your house!

RIN8SB1S7-BEN0	Spotlight Camera - Battery - Black	174.00
RIN8SB1S7-WEN0	Spotlight Camera - Battery - White	174.00
RIN8SH1P7-BEN0	Spotlight Camera - Wired - Black	174.00
RIN8SH1P7-WEN0	Spotlight Camera - Wired - White	174.00



Hard-wired



Battery

Ring Floodlight Cameras



- Two ultra bright LED floodlights
- 110db siren/alarm.
- World's only motion activated security camera with built-in floodlight!



The world's only motion-activated HD security camera with built-in floodlights, a siren alarm and two-way talk

RIN8SF1P7-BEN0	Floodlight Camera - Black	191.00
RIN8SF1P7-WEN0	Floodlight Camera - White	191.00

Voice Control

Amazon's Alexa, Apple's Siri, and Google's Google Assistant are taking the smart home industry by storm to improve efficiency. Home lighting systems, thermostats, and more recently complete home automation systems are integrating the technology to provide consumers with a hands-free mode of managing the electronic devices in their homes. There are many types of Home Automation Systems protocols like Bluetooth, Z-Wave, Zigbee, and more commonly, the traditional hardwired system. Each type has its own advantages and disadvantages.

Amazon Alexa's Echo and other Alexa devices let you instantly connect to Alexa to play music, control your smart home, get information, news, weather, and more using just your voice. To control your smart home using Alexa, you can use commands such as:

"Alexa, Turn off the TV."
 "Alexa, set master bedroom to 67 degrees."

Google Home allows you to control over 1,000 smart home devices including lights, switches, plugs, thermostats, and more using Google Home. To control your smart home using the Google Home, you can use commands such as:

"OK Google, Lock the front door."
 "OK Google, How warm is the living room?"

Apple Homekit allows you to easily and securely control all your HomeKit accessories. Ask Siri to turn off the lights from your iPhone. See who's at the front door on your iPad. Control things remotely with the help of Apple TV. You can use commands such as:

"Hey Siri, turn the porch light on."
 "Hey Siri, run "Goodbye" Scene."

Manufacturer

Page



Manufacturer	Page	amazon alexa	Google Home	Apple HomeKit
Arlo	Pg. 147	Yes	No	No
August	Pg. 27	Yes	Yes	Only with Connect or Doorbell
Aprilaire	Pg. 107	Yes	No	No
Alarm.com	Pg. 116	Yes	Yes	No
Centralite Villa	Pg. 65	Yes	No	No
Fibaro	Pg. 10	Yes	Yes	No
Harmony Remote	Pg. 41	Yes	No	No
Homeseer/Leviton Omni	Pg. 96	Yes	Yes	No
Jasco	Pg. 33	Yes	No	No
Lutron Caseta	Pg. 58	Yes	No	Yes
Lutron RadioRA 2	Pg. 48	Yes	No	Yes
RA 2 Select	Pg. 49	Yes	No	Yes
Leviton decora smart Wi-Fi	Pg. 15	Yes	Yes	No
Leviton decora smart HomeKit	Pg. 15	No	No	Yes
Nest	Pg. 42	Yes	Yes	Yes
Philips Hue	Pg. 43	Yes	Yes	Yes
Rachio	Pg. 43	No	Yes	No
Ring	Pg. 37	Yes	Yes	No
Russound	Pg. 148	Yes	No	No
Schlage Sense	Pg. 26	Yes	No	Yes
SmartThings	Pg. 16	Yes	Yes	No
Skybell	Pg. 116	No	Yes	No
URC Homeseet	Pg. 40	Yes	No	No
Vera Controls	Pg. 18	Yes	Yes	No
Wink	n/a	Yes	Yes	No
Zipato	Pg. 13	Yes	No	No

LuxePort - The Next Level of iPad Charging and Mounting



DAN71011

LuxePort is the ultimate expression of refined aesthetics in an iPad charger and mount. The system consists of a Case and Stations for charging on a table-top or wall. It allows an iPad to blend into high-end installations with precision-machined components which are finished by hand. The LuxePort Case can lock onto the Base or WallStation to securely mount and charge the iPad.

- Table-top mount and charge iPad in portrait or landscape mode
- Adjustable angle
- Optional Charge Module adds-on two USB ports



DAN71002



LUXEPORT

iPad Model	LuxePort Cases (Wall or BaseStation sold separately)	
iPad Pro 10.5"	DAN71015 (black)	210.00
	DAN71016 (silver)	210.00
	DAN71017 (white)	210.00
iPad Pro 9.7"	DAN71012 (black)	210.00
iPad Air 2	DAN71013 (silver)	210.00
iPad 5th gen.	DAN71014 (white)	210.00
iPad mini 4, 3, 2, and 1	DAN71009 (black)	175.00
	DAN71010 (silver)	175.00
	DAN71011 (white)	175.00

LuxePort BaseStations		
DAN71000 (black)		280.00
DAN71001 (silver)		280.00
DAN71002 (white)		280.00



DAN71005

- Wall mount and charge iPad in portrait or landscape mode
- PoE or 24V powered
- Optional Wall Adapter to cover one-gang hole

LuxePort WallStations		
DAN71003 (black)		245.00
DAN71004 (silver)		245.00
DAN71005 (white)		245.00

LuxePort Accessories		
DAN71006 Wall Adapter (black)		35.00
DAN71007 Wall Adapter (silver)		35.00
DAN71008 Wall Adapter (white)		35.00
DAN71018 Charge Module (blk)		70.00
DAN71019 Charge Module (slvr)		70.00
DAN71020 Charge Module (wht)		70.00

Other iPort Product Selections

iPort offers additional solutions for mounting and charging an iPad. Use the following table to find your customer's iPad model and the mounting solution. More details and additional accessories (when available) for each mounting solution can be found at the bottom of this page.



iPad Model	Removable Table-Top or Wall-Mounted		Surface Wall-Mounted		Surface Wall-Mounted with Six IP Buttons		Surface Wall-Mounted with Ten IP Buttons	
	Launchport Sleeve (Wall or BaseStation sold separately)		Surface Mount Bezel (splitter sold separately)		Surface Mount Bezel with IP Buttons (splitter included)			
iPad Pro 12.9"			DAN70743 (black)	335.00	DAN70778 (black)	550.00	DAN70781 (black)	600.00
			DAN70744 (silver)	335.00	DAN70779 (silver)	550.00	DAN70782 (silver)	600.00
			DAN70745 (white)	335.00	DAN70780 (white)	550.00	DAN70783 (white)	600.00
iPad Pro 9.7"	DAN70300 (black)	105.00	DAN70703 (black)	230.00	DAN70767 (black)	454.00	DAN70761 (black)	489.00
iPad Air 2			DAN70704 (silver)	230.00	DAN70768 (silver)	454.00	DAN70762 (silver)	489.00
iPad 5th gen.	DAN70301 (white)	105.00	DAN70705 (white)	230.00	DAN70769 (white)	454.00	DAN70763 (white)	489.00
iPad mini 4			DAN70722 (black)	195.00	DAN70764 (black)	419.00	DAN70758 (black)	454.00
			DAN70723 (silver)	195.00	DAN70765 (silver)	419.00	DAN70759 (silver)	454.00
			DAN70724 (white)	195.00	DAN70766 (white)	419.00	DAN70760 (white)	454.00
iPad mini 3			DAN70700 (black)	195.00				
iPad mini 2	DAN70305 (white)	99.00	DAN70701 (silver)	195.00				
iPad mini 1			DAN70702 (white)	195.00				

*Note: The iPad Pro 9.7" model's top speakers and camera flash may be covered.

			Surface-Mount Accessories		
DAN70170	LaunchPort WallStation (black)	140.00	DAN70718	PoE Splitter - for all bezels, requires PoE	84.00
DAN70142	LaunchPort WallStation (white)	140.00	DAN70719	PoE Injector	35.00
DAN70141	LaunchPort BaseStation (silver)	140.00	DAN70720	Glass Mounting Kit	14.00
DAN70158	LaunchPort BaseStation (black)	140.00			

Call Worthington Distribution for more information on iPort solutions. (800) 282-8864

Guardian By Elexa

More people suffer from water damage than fire and theft combined with more than 14,000 water damage claims a day! Guardian is a system of Leak Detectors and a Valve Controller that work together to detect leaks and shut off your water automatically, preventing further damage. Guardian installs with no tools, no plumber, and no pipe cutting - Simply install, connect, and protect!

The Valve Controller installs out of the box with no tools - hand-tighten the clamps to secure everything to your quarter-turn ball valve. Guardian will self test by opening and closing your valve weekly to keep it in good condition and to ensure proper operation during emergencies. With the optional battery backup (Coming soon) Guardian will protect your home and shut off your water supply during leaks for up to twelve hours without electricity.

To view our first hands on video with the Guardian by Elexa, please scan the QR code here and you will be directed to our Youtube page!

DOMGVC1	Guardian Valve Controller	200.00
DOMGLD1	Guardian Leak Sensor	42.47
DOMGVD3	Guardian Valve kit including 3 Leak Sensors	318.00



Z-Wave bridge for Guardian is coming soon! Call us for more details!

Guardian App

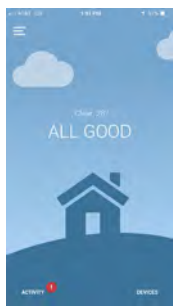

The home screen supplies updates on the whole system including local weather.

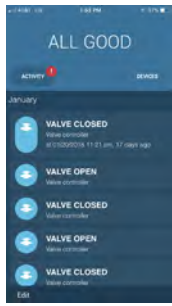

The Activity screen gives you full details on the events that have happened in the system including presence of water and temperature readings.

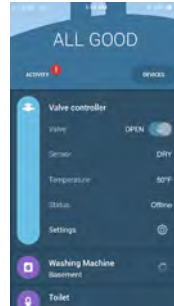

The Device screen for the valve gives you live status as well as the option to manually control the valve via your smart phone any time you'd like.

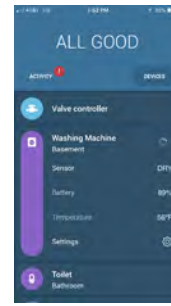

The Device screen for the sensors gives you live status on the presence of water as well as temperature in the sensor locations.



URC, with 25+ years of experience in the smart home automation and control industry, introduces HomeSet, a streamlined system optimized for the home security solutions channel. This is a completely new system built from the ground up by URC - new technology, new hardware, new software. It utilizes cloud-based programming and maintenance, and offers cloud compatibility with other cloud-based systems. HomeSet integrates with Z-wave devices, Nest, and hundreds of other popular devices and can control up to eight (8) rooms.



URCHS-R100



URCHS-C100



URCTRF-ZW2

URCHS-R100	URC HomeSet Wi-Fi Remote Control - Hub Required	180.00
URCHS-C100	URC HomeSet Control Hub	180.00
URCTRF-ZW2	URC HomeSet Z-Wave Gateway	138.00



URC HomeSet Interface

The included HomeSet app is unique and allows rapid launching of up to eight embedded apps including full compatibility with control apps from all lines that we carry including Nest, Fibaro, and Leviton. For example, the app will give you the ability to efficiently switch from your URC app to your Lutron lighting app and turn off your lights before switching back to the URC HomeSet app.

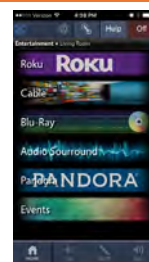

- Link your HomeSet App with your favorite streaming apps including Roku, Pandora and Hulu.
- Create custom buttons to run a scene for any kind of situation.
- Add your favorite T.V. channels to your favorites tab to get a quick shortcut so you don't miss any action.



Logitech Harmony Products

Streamline your life with intuitive, integrated control of both home entertainment and home control devices. Change channels, adjust volume, fast-forward, or rewind using gestures on the bright 2.4" touchscreen. Easily find the right button, even in the dark, with motion-activated, backlit controls. Keep your eyes on your entertainment, not your remote, with vibration feedback. Customize the dedicated media playback, cable/satellite, and DVR controls to your preferences. Control and adjust smart home devices with dedicated controls. Keep Harmony Elite charged and ready with the convenient charging station. The replaceable battery has 20% greater capacity than previous generation Harmony remotes.

Harmony Pro Remote

HAR915-000273	Harmony Pro Remote	300.00
---------------	--------------------	--------

Logitech Harmony has come up with a solution for the dealers in this field. They have started to offer the Harmony Pro remote. This remote has an extended warranty, more durable plastic and it is not sold online for retail customers giving our dealers a little piece of mind!

Benefits of the Harmony Pro version:

1. Extended warranty. - 2 years
2. More durable plastic and more durable feel.
3. Not for sale online. **DEALER ONLY!**



Home Hub Controllers

HAR915-000256	Harmony Elite Controller and Hub	262.49
HAR915-000239	Harmony Companion Controller and Hub	112.49
HAR915-000245	Add-on Smart Control Controller	22.49



HAR915-000256

HAR915-000245

HAR915-000239

Universal IR Remotes

HAR915-000230	Harmony 350 IR Remote	37.49
HAR915-000159	Harmony 650 IR Remote	59.99
HAR915-000224	Harmony Ultimate One IR Remote	187.49



HAR915-000230

HAR915-000159

HAR915-000224

Harmony Hub

HAR915-000238	Harmony Hub, use with Android or iOS app or purchase with a remote above.	74.99
---------------	---------------------------------------------------------------------------	-------

The parts or kits above show the Harmony Hub have it included. The Remote uses RF to communicate. The hub has a built-in IR blaster and includes two additional IR emitters so you can place it in a rack or cabinet without issue. It also supports iOS and Android with free apps that let you use a smartphone as an additional remote. The

Harmony Hub connects to your network to enable integration with Nest, Caseta, and many more. You can add the Home Hub extender to support Z-Wave and ZigBee products.



Home Hub Extender

HAR915-000253	Harmony Home Hub Extender, Harmony Hub Required	74.99
---------------	-------------------------------------------------	-------

Harmony Home Hub Extender integrates ZigBee®, Z-Wave™ and Z-Wave Plus compatible devices with your existing Harmony Hub. You can include these devices in your programmed schedules and activities for enhanced home control. Or, you can use your Harmony remote or app to control devices connected to an existing smart home control platform.



Harmony and Alexa

Control your entire home entertainment experience without lifting a finger. With Harmony and Amazon Alexa or Google Home, you can enjoy easy, hands-free control of all the things you love. Turn on your TV, change channels, control volume, or start an Activity like "Good Morning" to play a favorite music playlist, raise the blinds, set the lights, and warm the house temperature. Your voice makes it all work, just like magic.



Smart Phone App

Program and control devices through the highly intuitive Harmony Remote Smart phone app. The app is available through the iOS and Android app stores.

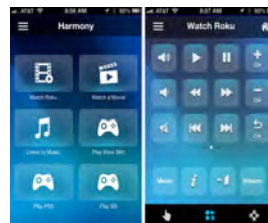

With the Logitech Harmony app, you will have the ability to control any devices in your system including TV's, DVR's, Lights and Locks. This intuitive interface also includes scenes that would make your home theatre very easy to control and enjoy!

Become a Nest Pro!



The Nest family of products includes the Nest Learning Thermostat, Nest Protect, Nest Cam Indoor, and Nest Cam Outdoor as well as the Nest IQ cameras, Alarm and Hello doorbell. Become a Nest Pro and start to sell and install these award-winning products that are making the home more intelligent. You'll get exclusive training and tools, live VIP support, and customer referrals to help your business grow!



Scan the code or go to pro.nest.com to get certified.

Nest Learning Thermostat

Use the Nest app to connect to your thermostat from a phone. Getting in early? Change the temperature from anywhere in the world.

NEST3008US	Nest 3rd Generation Thermostat - Carbon Black	209.99
NEST3016US	Nest 3rd Generation Thermostat - White	209.99
NEST3017US	Nest 3rd Generation Thermostat - Copper	209.99
NEST3021US	Nest 3rd Generation Thermostat - Silver	209.99
NEST4001ES	Nest thermostat E Pro	143.07



Nest Standard Thermostat



Nest E Thermostat

Most people leave the house at one temperature and forget to change it. The Nest Learning Thermostat learns your schedule, programs itself, and can be controlled from your smartphone. Teach it well and the Nest Thermostat can lower your customers' heating and cooling bills up to 20%. That is just one of many great selling points.



Black White Copper Silver Nest E

The main difference between the Nest and the Nest E thermostats become apparent when you look at the wiring plate. The Nest E will have wires for most conventional systems, while the Nest Standard will have terminals for advanced heating and cooling systems.

NEST5000SF	Temperature Sensor, can be mounted on-wall or set on a shelf. Place in multiple rooms and set priority.	32.40
NEST5001SF	3-pack of T5000SF	82.08



NEST5000SF

Nest Protect

- If Nest Protect sees smoke or carbon monoxide levels rising, you'll get a friendly heads-up warning before it sounds an alarm.
- Usually Nest Protect has its light turned off but when you walk underneath it in the dark, the pathlight will turn on to light your way.
- If one Nest Protect senses danger, every Nest Protect in the house speaks up. For example: the Nest Protect in the bedroom will tell you if there's smoke in the living room. In addition to alarm sounds, Nest Protect uses a human voice to help kids wake up.



NESS3004PWBUS	Protect Smoke Alarm - battery-operated	119.00
NESS3005PWLUS	Protect Smoke Alarm - hardwired - 110VAC	119.00

Nest Cam Indoor/Outdoor

60 second setup - Use the Android or iOS app to find your Wi-Fi network, live stream in under a minute. High quality video - get into the details with 1080p high-definition video. Field of View - 130 degrees diagonal, plus night vision, and zoom means you don't miss a thing. Cloud Video Recording (CVR) - review footage and make clips with optional secure offsite recording. Stay connected with two-way talk, intelligent alerts, scheduling, and mobile & web apps.



NESNC1103US



NESNC3100US

NESNC1103US	Nest Cam Indoor Camera - Anthracite	179.99
NESNC2100ES	Nest Cam Outdoor Camera - White	179.99
NESNC4101US	Nest IQ Cam - Outdoor, 4K with Face Alert	289.99
NESNC3100US	Nest IQ Cam - Indoor, 4K with Face Alert	258.00

Nest Hello



Nest Hello lets you know who's there, so you never miss a thing. It replaces your existing wired doorbell and delivers HD video and bright, crisp images, even at night. It's designed to show you everything at your doorstep - people head to toe or packages on the ground. And with 24/7 streaming, you can check in anytime. Or go back and look at a 3-hour snapshot history to see what happened.

NESNC5100US	Nest Hello Doorbell Camera	198.00
-------------	----------------------------	--------

NEST x YALE Lock

This secure, tamper-proof, key-free deadbolt connects to the Nest app. You can lock and unlock your door from anywhere. Give passcodes to guests. Set up expiration times. And get alerts whenever someone comes and goes.



Requires Nest Connect or Nest Guard (included in the Nest Secure starter pack) to work with the Nest app.

If the batteries start running low, you'll know right away. And if your lock loses power, you can quickly charge it with a 9V battery.

YALYRD54-WV0BP	Nest x Yale, includes Nest Connect, Bronze	251.05
YALYRD54-WV605	Nest x Yale, includes Nest Connect, Brass	251.05
YALYRD54-WV619	Nest x Yale, includes Nest Connect, Nickel	251.05

Nest Secure

Arm the alarm and take your time leaving. With No Rush arming and disarming, Nest Secure lets you choose how much time you need. A friendly voice tells you how much time you have left. And if you forget to set the alarm, you can get a Remind Me alert so you can arm right from your phone.

NESH1500ES	Nest Secure Alarm System Starter Kit - Includes Nest Guard, Nest Detect and Nest Tag	419.99
NESH1100WES	Nest Detect - Motion and open/close movement	48.99
NESH13000ES	Nest Tag - Keyfob for arming and disarming Nest Secure	20.99
NESH17000US	Nest Connect - Range Extender for Nest Secure Systems	56.99



NESH1100WES

Stick Nest Detect on a window and you'll know when it opens. Stick it on a wall and it senses motion in a room. Better yet, stick it on a door and it can do both.



NESH1500ES

Give Nest Tag to family or people you trust. Set a schedule to let someone in at certain times, like your dog walker. And don't worry if you lose one. You can easily disable it in the Nest app.



NESH13000ES

Rachio



Rachio smart sprinkler controllers gives you the freedom to control your sprinkler from your smart phone or mobile device. Cloud based weather data and embedded software can help deliver 20%+ savings to your irrigation water bills. This is available in 8 Zone and 16 Zone configurations.



RAC8ZULW	8 Zone Intelligent Sprinkler Controller	159.87
RAC16ZULW	16 Zone Intelligent Sprinkler Controller	199.84

Google Home - Voice Control



Google Home is a voice-activated speaker powered by the Google Assistant. Ask it questions. Tell it to do things. It's your own Google, always ready to help. Just start with, "Ok Google". With Google Home, or the Google Home Mini, you can gain voice control of all of your favorite home automation equipment including Nest, SmartThings and Philips Hue products in addition to a barrage of other features.

NESWNGOGA3A0041	Google Home Voice Control	103.99
NESWNGOGA210US	Google Home Mini - Chalk White	44.00
NESWNGOGA216US	Google Home Mini - Charcoal Black	44.00



Google Home



Charcoal Black



Chalk White

Google Wi-fi

NESWNGOGA3A0440	Google Wi-fi - Single	108.00
NESWNGOGA3A0441	Google Wi-Fi - 3 pack	264.00

- Google Wi-fi replaces your router and works with your modem and ISP, so you can stream, download and share without missing a beat.
- With this system, we have the ability to create a mesh network of access points to cover any type of home!
- Schedule a regular Wi-Fi pause on your kids' devices, like at bedtime or dinnertime. Plus, block access to millions of explicit websites.
- The Google Wifi app lets you see what's connected, run a speedtest, quickly troubleshoot, set up a guest network and more.



Google Wi-Fi 3-pack

Philips Hue



With your color lighting at your finger tips, you can set any mood you'd like! With the advanced scene option, you can choose images to base your color scene on.

The Philips Hue starter kit includes the Philips Hue Hub as well as 3 RGBW LED bulbs.

NESWNP464479	Philips Hue starter kit	174.86
--------------	-------------------------	--------



Caséta by LUTRON

Increase revenue and easily
add lighting control to every job

Features and Benefits:

- ELV+ Dimmer — ideal for LED and ELV loads as well as incandescent, halogen, MLV and more.
- Plug in lamp dimmer can now extend the wireless range of a system by 30 ft (limit 1 per system).
- Nest Home/Away Assist — automatically turns lights on upon arrival and off when everyone leaves. If Nest Cam detects a person while away, lights can turn on to make it look like you're home.
- Also works with other leading brands like: Amazon Alexa, Apple HomeKit®, Alarm.com, ELK, Google Assistant, Logitech, Samsung SmartThings and more!



The Smart Bridge PRO, Lutron App for smart devices, 4-button Pico remote PRO, In-wall dimmer PRO and plug-In lamp dimmer

 **LUTRON**

casetawireless.com

Apple, HomeKit, and Siri are trademarks of Apple Inc, registered in the U.S. and other countries. Android is a trademark of Google Inc.

LEVITON Omni-Bus	Centralite: Elegance XL	Simply Brilliant	LEVITON HLC	PCS Powerline Control System PulseWorx	LUTRON Caséta	LUTRON RadioRA 2 Select	LUTRON RadioRA 2	Centralite: Villa	Z-Wave	LEVITON Z-Wave	
N	Y	Y	N	N	N	Y	Y	N	Y	Y	Fan Speed Control
Y	Y	N	N	Y	N	Y	Y	Y	N	Y	Elec. Low Voltage
256	720	256	256	256	50	100	200	100	232	128 (232)	Max. Devices
N	N	Y	Y	Y	Y	Y	Y	Y	Y	Y	Retrofittable
600	2400	900	2400	2400	600	1000	1000	600	600	1000	Max. Dimmer Watt.
14	20	8	15	8	5	8	8	8	15	15	Max. Switch Amp.
Y	Y	N	Y	Y	Y	Y	Y	Y	Y	Y	LED Supported
Bus	Bus	Coupler/ Repeater	Coupler/ Repeater	Coupler/ Repeater	N/A	Fixed Repeater	Fixed Repeater	Mesh Network	Mesh Network	Mesh Network	Network Integrity
Central Cabinet	Central Cabinet	Neutral Required	Neutral Required	Neutral Required	Standard	Standard	Standard	Neutral Required	Neutral Required	Standard	Wiring
Y Built-In 3.0+	Y Built-In 2.10+	Y Built-In 2.7+	Y Built-In 2.7+	Y Built-In 2.7+	N	N	Y Built-In 3.3B+	Y Built-In 2.14+	Y Built-In 2.14+	Y Built-In 2.14+	Omni Supported
Y	O	Y	N	Y	N	Y	Y	Y	N	N	I/O Modules
N	N	Y	N	Y	N	N	N	N	Y	Y	Controlled Repts.
N	N	Fixture / Dimming	N	Y	N	Y	Y	N	N	N	Wired Modules
RS-232	RS-232	RS-232 PIM	RS-232 PIM	RS-232 PIM	N/A	N/A	RS-232	RS-485 ZIM	RS-232 PIM	RS-232 PIM	Omni Interface
N	L, A	L, A	L, A	L, A	L	L, A	L, A	L, A	L, A	L, A	Plug-In Modules
Y	Y	N	Y	Y	N	N	Y	Y	N	Y	Two-Way w/ Omni
N	N	N	N	N	Y	Y	Y	N	N	Y	Two-Wire Devices*
Y	Y	Y	Y	Y	Y	Y	Y	Y	Y	Y	Scene Capable
Y	N	N	Y	Y	Y	Y	Y	Y	Y	Y	Wireless Remote
Wired		UPB			Wireless/RF						

Y=Yes; N=No; O=Available as an Option; N/A=Not Available; L=Lamp; A=Appliance

*Dimmable fluorescents supported

The information in this chart was gathered from manufacturer websites, tech support and literature. Confirm specs with Worthington prior to ordering. Worthington Distribution's knowledgeable staff can help with any questions you may have.

RA2 Select

Whole home lighting control made simple



SIMPLE. FAST. FLEXIBLE.

Easy app setup

Automated system configuration

Connect up to 100 devices
throughout the home

Visit lutron.com/RA2Select to learn more.





Elegance XL and Villa

When it comes to speed and reliability, there is no substitute for a hard-wired lighting system. Elegance XL is the value leader for any size home. Dimming cabinets combined with multi-button keypads eliminate wall clutter. JetStream is a mesh wireless solution that can be used for simple to elaborate applications.



Lutron Lighting

A wireless total home control system engineered to be as solid as a hardwired system. The ultra-reliable fixed repeater network is flexible for retrofit and new installations. It is a scalable solution for basic to the most advanced applications. Between Caseta, RA2 Select and Radio RA2, Lutron has a solution for you!



Universal Power Line Bus (UPB)

A reliable power line technology, UPB is available from 3 companies: PCS, Leviton Security and Automation, and Simply Automated. Omni users can program devices from the controller. Other implementations use free UPStart PC programming software.



ZigBee

A wireless technology with many chip manufacturers and implementations. Look for products that use the Home Automation profile. Before the Home Automation profile, all ZigBee products used the same radio technology but products were not interoperable.



Z-Wave

A wireless technology with a standardized radio protocol. Z-Wave solutions exist for more than just lighting. It is an RF technology for controlling thermostats, window treatments, locks, water valves, sirens, and many more devices!

Lighting Manufacturer	Application	Technology	Page
Aeotec	Mesh Wireless	Z-Wave	19
Centralite	Mesh Wireless	Villa	65
Centralite	Hardwired	Elegance XL	67
GE / Jasco	Mesh Wireless	Z-Wave	33
HLC (HAI Lighting Control)	Powerline Carrier	UPB	91
Leviton Z-Wave	Mesh Wireless	Z-Wave	16-17
Linear	Mesh Wireless	Z-Wave	23
Lutron RadioRA 2	Fixed Repeater Wireless	ClearConnect	48
Lutron RA 2 Select	Fixed Repeater Wireless	ClearConnect	49
Lutron Caseta	Fixed Repeater Wireless	ClearConnect	58
PulseWorx (PCS)	Powerline Carrier	UPB	60-61
Simply Automated	Powerline Carrier	UPB	62-63

Window Treatments

Drapes, shades, blinds and other motorized treatments can be used as natural light control. In many cases window treatments can be integrated with the lighting system for total room control (p. 52-53 and 71-78).

Convenience

Timers are typically used to control lights for holidays and security applications. Why not centralize all of the timers into a single controller? In addition, add the simplicity of All Off when you go to bed. Lighting can now be controlled by more than just time.

Remote Access

We are now in the age of Smart Phones. Why not control your home from your own web page or home control application?

Energy Management

As energy prices continue to increase, consumers are looking for ways to control high-wattage devices. Current technologies make it easy to control lighting as well as high-wattage devices such as the hot water heater.

Scene Lighting

Controlling groups of lights with a single command can change a room's look and feel at the touch of a button. Dimmers can be used to set a mood in a room and to draw attention to architectural elements.

Home Theater

Lighting control is a key element for home theater installations. Controlling lights and shades in your home theater will help to create the perfect viewing experience. See solutions for iPad control via the Leviton Security and Automation SnapLink Mobile applications.

Temperature Control

The largest consumer of energy in the home is the HVAC system. Many lighting communication technologies include thermostat control.

Security Integration

Lighting control is an excellent addition to any security application. Turn lights on at sunset and off later in the evening. Pathway lighting reduces the potential for falls. Vehicle detection (p. 109 and 110) can be used to turn on key lights and alert the homeowner to a vehicle arriving.

Landscape Lighting

Outdoor lighting is profitable and easy to control. Many lighting control systems can control magnetic loads. Simply check for load types when choosing the proper dimmer.

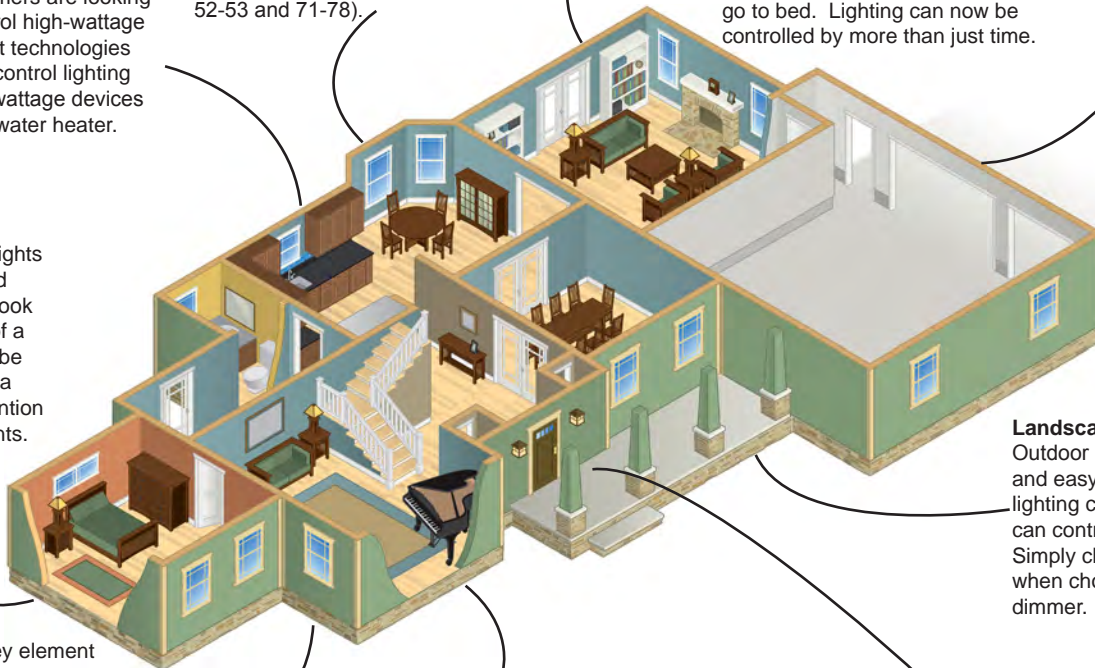

RadioRA 2

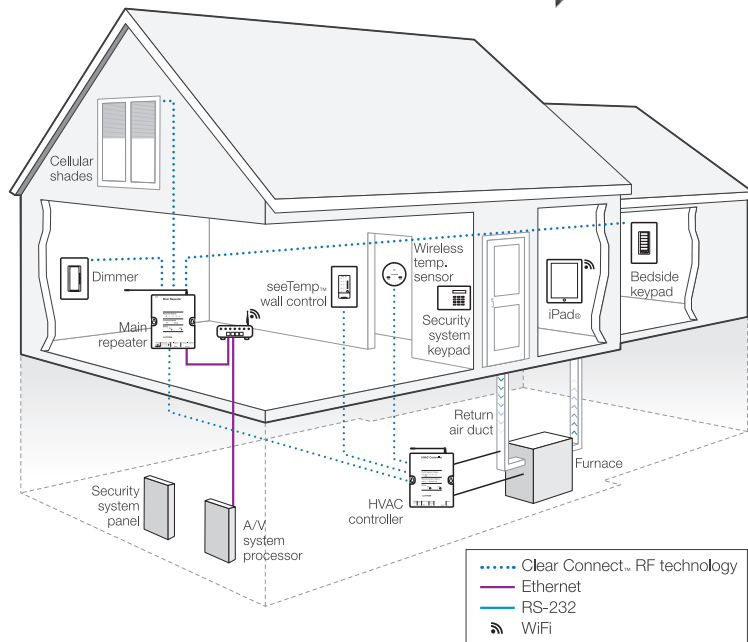

RadioRA 2 is a robust wireless home control system that provides convenient and intuitive control of lights, shades, temperature, and appliances in a single room or throughout an entire home. RadioRA 2 uses standard wiring topography familiar to any electrician, making it perfect for any new or retrofit installation. The system is scalable, programs quickly, and operates with ultimate reliability thanks to Lutron's Clear Connect™ RF Technology.

RadioRA 2 is one of the most exciting lighting systems to enter the automation marketplace. Clear Connect™ RF Technology allows systems to grow from a simple home theater application with a handful of devices to a complete 200 device automated home. The brand new Connect Bridge takes this full eco-system product to the next level of automated control.

Heart of the System: Main and Auxiliary Repeaters

RadioRA 2 uses a fixed repeater network to ensure a smooth, ultra-reliable, error-free lighting system. The core of any whole house RadioRA 2 installation starts with a main repeater. The main repeater uses wireless ClearConnect™ RF technology to talk to any RadioRA 2 device. The main repeater also incorporates a serial and Ethernet port for integration to third party automation systems as well as the Lutron Home Control+ app.

LURRMAINREPWH	RadioRA 2 Main Repeater	311.63
LURRAUXREPWH	RadioRA 2 Auxiliary Repeater	186.73



LURRAUXREPWH

LURRMAINREPWH

Lutron guarantees communication 30ft in any direction through any construction from a repeater; greater distances are common. To extend the size of a system simply use an Auxiliary Repeater. Up to 60ft from a main repeater, auxiliary repeaters are connected via a wireless RF link. For remote locations up to 1000ft away, simply use 18/2 and 22/2 shielded to hard-wire an auxiliary repeater for full control.

Guaranteed Reliability

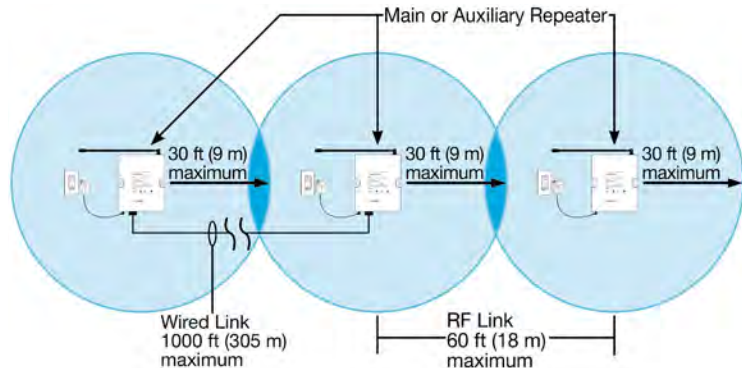

436.53

Connect Bridge

Turn Your Lights On
Adjust Your Thermostat
Disarm Your Security System
Just by driving home...



LUCONNECTBDG1



The Lutron Connect Bridge provides geofencing to trigger lighting and HVAC scenes within the home. By utilizing the Connect Bridge, remote access for control and monitoring of the RadioRA 2 system is now FREE via the Lutron Connect app. Cloud-based timeclock syncing ensures accurate system time. Simply make sure the Connect Bridge is connected to the same network as your Main Repeater.

LUCONNECTBDG2	Connect bridge. Provides remote access for control and monitoring of the RadioRA 2 system via the FREE Lutron Connect app.	187.35
---------------	----------------------------------------------------------------------------------------------------------------------------	--------

LURRCONNECTPKH	Connect package. Includes both the Main Repeater and the Connect Bridge for a complete starter kit.	436.53
----------------	-----------------------------------------------------------------------------------------------------	--------

Total Home Control

Benefits of total home control

- Save Energy
- Add convenience to your daily life
- Create just the right mood or ambiance
- Control from inside or outside your home
- Implement cutting-edge technology in your home



RA2 Select

Heart of the System: Main and Auxiliary Repeaters

LURSELREP2BL	RA2 Select Main Repeater	155.50
LURRAUXREPWH	RA2 Select Auxiliary Repeater	186.73

The RA2 Select main repeater lets you control your lights and shades on your smartphone or tablet, from anywhere in the world using the free Lutron App. You can also use the versatile Pico remote for control throughout your home. The Pico is available as a keypad for scene control, or as a remote for individual light and shade control.

The main repeater supports up to 100 Radio RA2 devices, but will not work with the Lutron multi-button, hardwired keypads. In these situations, we would look at utilizing the 2 and 4 button scene Pico's.

Enjoy personalized smart lighting and shade control for any home, any budget, with RA2 Select. Added convenience. More comfort. Enhanced peace of mind. Staying in control of your home, even when you're not there.



LURSELREP2BL

Lutron App

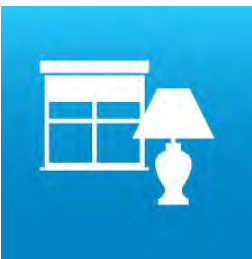

Easy system setup through the Lutron App automatically configures light and shade levels for typical activities. The pre-engraved Pico scene keypad guarantees every scene keypad in the home has an intuitive scene name, such as Bright, Entertain, and Relax, for those pre-set light and shade levels.

3-Way, No Wires? No Problem!

The Pico wireless keypads can be used to control ANY Lutron RadioRA 2 switch, dimmer, or plug-in device. This allows for a simple way to place an auxiliary or remote switch anywhere in a home.

Programming only takes 12 seconds, easy and fundamental. Simply press and hold the on/off button on the dimmer for 6 seconds. Then press the "Off" button on the Pico controller for 6 seconds. That is it, you are done and your hands are the only programming tools required!

Pico Applications

Adjust lights from anywhere in a space with a Pico wireless controller. This versatile and easy-to-use control requires no wires and is compatible with a wide variety of Lutron lighting and automated window treatment solutions.

All Picos include double-sided tape and bracket for these great application ideas:

- Under a granite countertop
- Behind a bed headboard
- Car visor
- Turn lights on when walking to your home at night
- At the bottom or top of the steps
- Lamp behind furniture (use a plug-in module)
- Any retrofit application



Pico™ Wireless Keypads

- Utilizes Lutron's ultra-reliable Clear Connect™ RF technology
- Easily add a new or additional point of control without the need for new wires
- Use as a handheld control, car visor control, wall-mount, or tabletop control
- Available in 4-button configurations and 5 finish options
- Text and icon labeling options available for lighting and window treatments
- 10-year battery life
- Simple two-step programming



LUPJ23BRLGWHL01

Clear Connect™ RF



LURRD6CLBG

LUPJ22BGWHL01	2-button Pico on/off with light icons; white	15.61
LUPJ23BRLGWHL01	5-button Pico with raise lower light icon; and favorite button; white	13.11
LUPJ24BGWHEL1	New 4-button scene Pico, each button is programmable. Free custom engraving.	61.83

2 and 4 Button Scene Picos



2-button and 4-button scene keypads are available preset and pre-engraved with common scenes, for typical activities in your home.

LUPJ22BG**P01	2-Button Entry Scene Pico	34.97
LUPJ22BG**P02	2-Button Bedside Scene Pico	34.97
LUPJ24BG**P02	4-Button Kitchen Scene Pico	34.97
LUPJ24BG**P01	4-Button Family Room Scene Pico	34.97
LUPJ24BG**P03	4-Button Any Room Scene Pico	34.97

Custom Engraved 4-Button Scene Pico's are available as well!

LUPJ24BG**EL2	4-Button Custom Engraved Scene Pico	61.83
---------------	-------------------------------------	-------

For more information, visit lutron.com/engraving.

Nearly 100 different color and button options! Call for more choices.

Pico Accessories



Pico with Car Visor Clip



Pico Pedestal Mounted



Dual Tabletop Pedestal

LULPED1*	Tabletop Pedestal Single Pico	9.37
LULPED2*	Tabletop Pedestal Dual Pico Keypads	18.74
LUPICOWBXADAPT	Pico Wallplate Adapter Kit	5.00
LUPICOCARVISORC	Pico Car Visor Adapter Kit	5.62
A1ILV1	Single Gang Retrofit Low Voltage Bracket	0.93

* Available in Gloss WH-White or BL-Black

Dimmers

LURRD6CL*	RadioRA 2 600W incandescent, 450W magnetic low voltage, 150W CFL LED dimmer. Two wire, no neutral required. **LED and CFL Friendly**	93.05
LURRD2ANF*	RadioRA 2 2A fan speed controller	124.28
LURRD10ND*	RadioRA 2 1000W neutral required, incandescent, magnetic low voltage, halogen dimmer. Single pole or multi-location. **LED and CFL Friendly**	124.28
LURRD6NA*	RadioRA 2 600W adaptive dimmer for incandescent, magnetic low voltage, and electronic low voltage. **LED and CFL Friendly**	124.28
LURRD6ND*	600W neutral required, incandescent, magnetic low voltage, halogen, LED dimmer **LED and CFL Friendly**	24.98
LURDRD*	RadioRA 2 remote dimmer for 120V 3-way applications.	24.98

For full details regarding **LED and CFL Friendly Dimmers contact Lutron: www.lutron.com/LED**

For additional questions, please call Worthington 800-282-8864



LURRD6CLDS



LURRD6CLBL



LURRD8ANSMN

Switches

LURRD8ANS*	RadioRA 2 8A light, 5.8A motor loads. Neutral required switch.	93.05
LURRD8SDV*	RadioRA 2 8A light, 3A motor loads. 120/277V. No neutral required.	124.28
LURDRS*	RadioRA 2 remote switch for 120V 3-way applications	24.98

**** LED and CFL Friendly**:** refer to above for details

Gloss: WH-White, IV-Ivory, AL-Almond, LA-Light Almond, GR-Gray, BR-Brown, BL-Black
Satin: HT-Hot, MR-Merlot, PL-Plum, TQ-Turquoise, TP-Taupe, ES-Eggshell, BI-Biscuit, SW-Snow, PD-Palladium, MN-Midnight, SI-Sienna, TC-Terracotta, GB-Greenbriar, BG-Bluestone, MS-Mocha Stone, GS-Goldstone, DS-Desert Stone, ST-Stone, LS-Limestone

See page 50 for color samples

Plug-in modules

LURRD3LD*	RadioRA 2 tabletop lamp dimmer 300W incandescent and magnetic low voltage	93.05
LURR3PD1*	RadioRA 2 plug-in dimmer 300W incandescent and magnetic low voltage	93.05
LURR15APS1*	RadioRA 2 plug-in relay 15A/0.5 HP all load types	93.05

* Available in Satin SW-Snow or MN-Midnight



LURRD3LDSW



LURR3PD1MN



LURR15APS1SW

Sell Your Customer a System Not Just A Dimmer

Talking to a customer about a price per dimmer can be very intimidating for that person. Talking about the cost of a lighting system is much more inviting. This gives you a reason to explain what the entire system will do rather than just an individual switch or keypad.

The chart below outlines typical lighting systems with components. If you would like a spreadsheet with your company logo and retail pricing give us a call. This chart sells lighting systems and helps estimate prices in a snap!

RadioRA 2 "Budget" Home Light Control System		Entry System	Premium System	Elite System	
Part Number	Description	Retail	5 Dimmer	10 Dimmer	20 Dimmer
LURRD6CLWH	600W RF Dimmer INC, MLV,150W CFL LED	\$149	5	10	20
LURDRDWH	Remote Dimmer	\$40	0	1	2
LURRDW6BRLWH	Wall-Mounted seeTouch RF Keypad	\$299	0	1	2
LULRF2OCR2BP	Radio Powr Savr Occupancy Sensor	\$85	0	1	1
LULR3BHSW	Car Visor RF Transmitter	\$50	1	1	1
LURRVCRXWH	Car Visor RF Receiver	\$299	1	1	1
LURRMAINREPWH	Main RF Repeater	\$499	1	1	1
LUCONNECTBDG2	Remote Connect Bridge	\$299	1	1	1
Total Retail Price of Components			\$1892	\$3061	\$4890
Total Dealer Price of Components			\$1234	\$1911	\$3053
Materials Profit			\$658	\$1150	\$1837

Welcome to the family... GRAFIK T

RadioRA 2 accessories have always come in beautiful color palettes. There are now two families of components available. Welcome the next generation of elegance and style with GRAFIK T. GRAFIK T is a Lutron level 2 product line. For training, please refer to page **.

Grafik T CL Hybrid Keypads and Dimmers

Grafik T CL Hybrid Keypads have an LED lightbar with a responsive touch interface that provides users with one-touch control. They are available in multiple engraved button configurations.

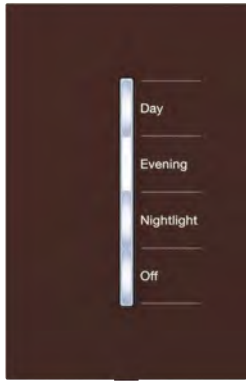

LURRTGH4BR

RadioRA 2 Grafik T CL Hybrid Keypad with 250W LED, 600W INC/HAL, 300VA MLV dimmer.

LURRTGH2B	2-button	342.85
LURRTGH4B	4-button	342.85
LURRTGH5B	5-button	342.85
LURRTGH6B	6-button	342.85

RadioRA 2 GrafikT Touch Dimmer. 250W LED 600W INC 300VA MLV.

LURRTG25LW	No neutral	155.50
LURRTG5NEW	Phase selectable	186.73
LURRTG5ANSW	120V 5A Switch	155.50

Wallplates must be added separately



LURRTG25LBL



Multi-gang Wallplate

Multi-gang Wallplates

With the Lutron product line, we can mix and match Grafik T and Architectural devices as well as multiple Grafik T devices. For more configurations give us a call at 800-282-8864.

Grafik T Wallplates



Plastic



Many color options...

Grafik T and Architectural wallplates are available in architectural matte and clear glass finishes. These wallplates provide a level of sophistication like none other.

Give us a call today to discuss all available options. 800-282-8864



Stainless Steel



Glass

Classic Decorator Style Keypads

Do not be concerned about choosing the correct button kit. Lutron's innovative keypads have the same body and all button configurations are interchangeable within each family of keypad. Every keypad comes with a pack of premium clear stickers for temporary use until the homeowner becomes familiar with the system. Each keypad comes with a free engraving certificate to customize the button configuration, color, and text.



LURRDW3BRLWH



LURRDW6BRLGB



LURRDW6BRLMN



LURRDW3BDSS



LURRDH6BRLDWH



LURRDH6BRLDTC

Wall-Mounted Keypads

RadioRA 2 wall mounted keypads. 6-button with raise/lower is most popular. 110VAC Only.

LURRDW7B*	7-button	186.73
LURRDW6BRL*	6-button with raise/lower	186.73
LURRDW3BRL*	3-button with raise/lower	186.73
LURRDW3BD*	Dual group, 3-buttons in each group	186.73
LURRDW2RLD*	Dual group, 3-buttons in top group and 2 buttons with raise/lower in bottom group	186.73

Hybrid Keypads

RadioRA 2 hybrid keypads. With built in 450W dimmer. 6-button with raise/lower is most popular.

LURRDH1RLD*	3-button with raise/lower dual group	249.18
LURRDH2RLD*	2-button with raise/lower dual group	249.18
LURRDH3BSRL*	3-button with raise/lower	249.18
LURRDH4S*	4-button	249.18
LURRDH5BRL*	5-button with raise/lower	249.18
LURRDH6BRLD*	6-button with raise/lower	249.18

All keypads are available in 26 different colors

Lutron Home Control + App

Homeowners may edit their own lighting levels right from the app. No need to roll a truck just to change a scene. A unique and valuable system asset. The Lutron Home Control + App is meant for the Radio RA2 system.

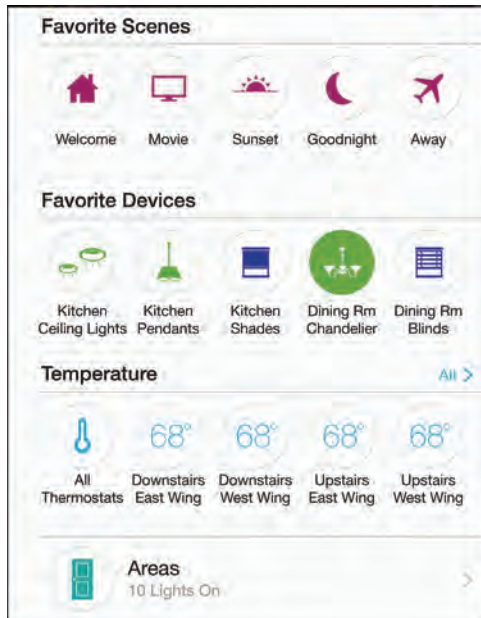

Lutron Caseta & RA2 Select App

Similar to the Home Control + App, the Lutron Caseta & RA2 Select App will allow your customers to edit their own lighting levels directly from the app. With this app, we can see the status of your home & control your lights, shades, and other devices from anywhere!

- View the lights that are on in your home and turn them all off with the touch of a button.
- Create just the right light for your favorite activities.
- Schedule your lights, shades and other devices to adjust automatically at certain times of the day!
- Turn on favorite scenes using the Widget!

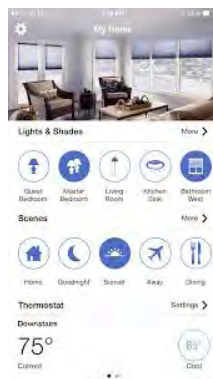

Lutron Support

Not only does Lutron have a phenomenal product line, they also offer some really helpful support for all of their products! Between their online support center that breaks your issues down to the specific part you are having an issue with and their phone support, Lutron has a way to help you out of a tough situation!



Radio **RA2** **RA2**Select *Caseta* Wireless

Lutron Technical Support: (800) 523-9466

www.Lutron.com/Support

Worthington Technical Support: (800) 282-8864

RadioRA 2 Training

RadioRA 2 Level 1 Training

Duration: 6-hours self paced online or 1 day in-classroom

- Online or classroom certification, call for details
 - System size: up to 100 devices
 - Systems are designed and programmed using RadioRA 2 Essential Software
- #### RadioRA 2 Level 2 Training
- Duration: 2-day in-classroom
 - System size: up to 200 devices
 - Specialty hardware such as the wallbox power and softswitch modules
 - Systems are designed and programmed using RadioRA 2 Inclusive Software
 - Training dates listed below for Level 2 training

Call to pre-register

April 9, 2018 - Irvine, CA
 April 12, 2018 - Oakland, CA

June 6, 2018 - Chicago, IL

July 26, 2018 - Coopersburg, PA

August 16, 2018 - Toronto, ON

September 9, 2018 - Chicago IL

October 2, 2018 - Plantation, FL

October 24, 2018 - Longueuil, QB

November 5, 2018 - Oakland, CA

November 8, 2018 - Irvine, CA

November 19, 2018 - Coopersburg, PA

Custom trainings available at Worthington Distribution. Not a substitution for official Lutron training.



LED Compatibility Tool

Need help confirming if your bulbs are compatible with the Lutron dimmer you want? Go to Lutron.com/LED for more info!



LED Bulb Compatibility Tool

- Find compatible bulbs and fixtures for dimmers available in stores near you



LED Report Card Tool

- Detailed information on recommended LED bulbs and fixtures
- Solutions for system-based dimmers

Lutron Fabrics Reference

Lutron is making things easier and easier every day for dealers to get the information they need to get the job done. When it comes to selecting the right fabric, we have the right resources to help you help your customer. Lutron has set up a web page that includes all of their exclusive fabrics. You can scan the QR Code here or go to www.lutronfabrics.com.

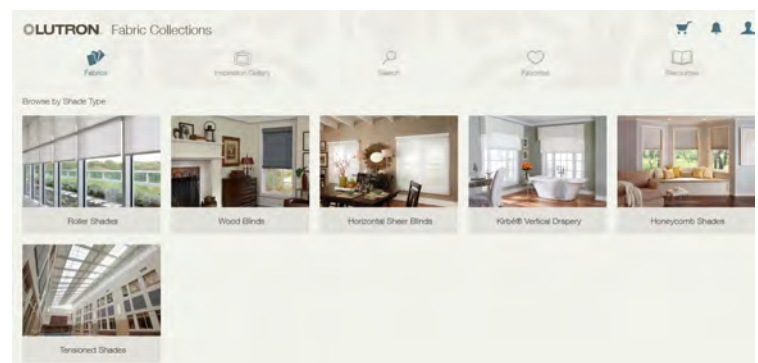

For a more physical reference, Lutron offers complete fabric books including the Roller fabrics as well as the Honeycomb fabrics.

LUROLLERBINDER	Complete roller fabric sample binder. Real fabric samples, all colors and styles included.	124.90
LUHONEYCOMBBIND	Complete honeycomb fabric sample binder. Real fabric samples, all colors and styles included.	93.68

Radio Powr Savr™ Occupancy and Vacancy Sensors

Lutron occupancy sensors are another great solution for standalone applications. Any Lutron RadioRA 2 dimmer or switch can work with any of the following sensors. These sensors can be paired with any RadioRA 2 switch or dimmer just like a Pico controller using a simple two-step button push process.

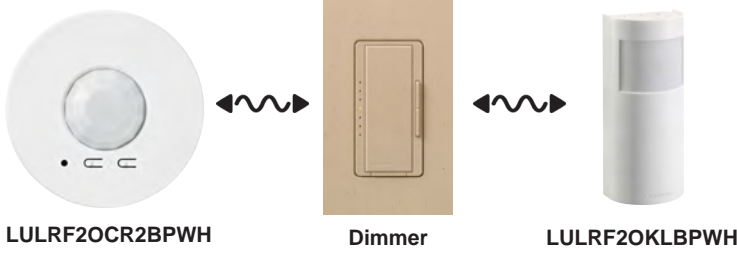

LULRF2OCR2BPWH	Ceiling occupancy/vacancy sensor; white	53.08
LULRF2VCR2BPWH	Ceiling vacancy only sensor; white	53.08
LULRF2OKLBPWH	Corner mount occupancy/vacancy sensor	53.08

Call for additional models

Car Visor Control

One of the most popular add-on sales for RadioRA systems has been the ability to control entry lighting from a car visor. With RadioRA 2, this is easily accomplished by adding a visor transmitter and a receiver. RadioRA 2 Visor Controls allow lights, shades / draperies, and other equipment to be controlled from the car with just a touch of a button on a Visor Control Transmitter or a HomeLink® compatible visor control.



LURRVCRXWH	RadioRA 2 Car Visor Receiver	186.73
LULR3BHSW	RadioRA 2 Car Visor Transmitter	30.60

Security and Integration

RadioRA 2 devices for interior lighting set to FULL ON

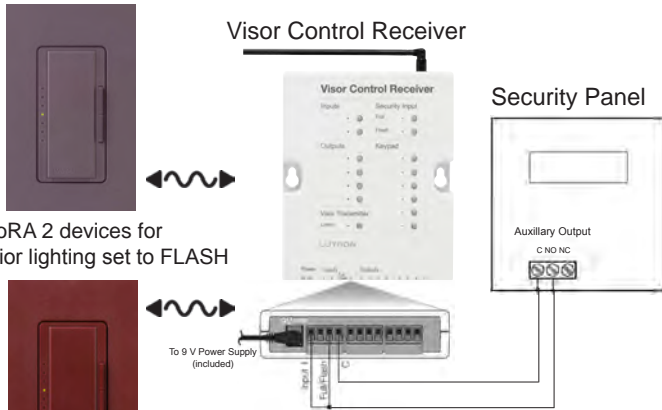

RadioRA 2 devices for exterior lighting set to FLASH

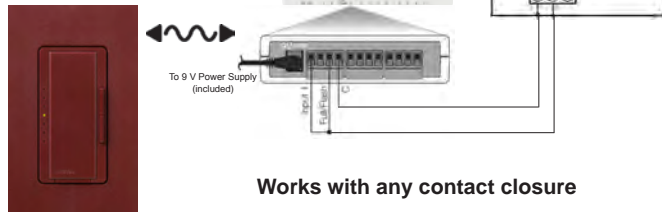

Works with any contact closure

RadioRA 2 is frequently interfaced with other systems within a home, such as security and fire alarm systems. Audible alarms are commonly utilized with these systems; however, the integration of lighting adds an enhanced level of security and peace of mind for the homeowner and their family. Simple programming allows an "ALL ON" feature to scare intruders while flashing exterior lights.

RadioRA 2 Integration Numbers

Integration Settings		
Telnet Logins	IDs	
Device/Zone	Enable for Integration	Integration ID
Dining Room	✓	2
Dining Room > Left > Left Hybrid (RRD-H58RL-WH)	✓	12
Dining Room > Left Dimmer	✓	10
Dining Room > Left Side	✓	11
Dining Room > Right > Right Hybrid (RRD-H58RL-WH)	✓	15
Dining Room > Right Dimmer	✓	13
Dining Room > Right Side	✓	14
Dining Room>Main Repeater 001 (RR-M43N-REP-WH)	✓	1

When programming for Omni integration, simply note the integration ID numbers that are conveniently located in the Lutron Essentials software. Use these numbers as the address for each component in PC access and have full home automation control with one of the lighting industry's premier lighting systems.

Tabletop Keypads

LURRT5RL*	RadioRA 2 tabletop keypad - 5 buttons with raise/lower, corded or cordless capable via 2 AAA batteries	249.18
LURRT10RL*	RadioRA 2 tabletop keypad - 10 buttons with raise/lower, corded or cordless capable via 2 AAA batteries	280.40
LURRT15RL*	RadioRA 2 tabletop keypad - 15 buttons with raise/lower, corded or cordless capable via 2 AAA batteries	311.63

*-Satin: SW-Snow, MN-Midnight

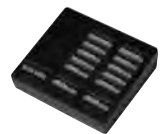

HVAC Control

Lutron offers a number of solutions for controlling HVAC systems. The first method uses the TouchPro™ thermostat which wires directly to the HVAC system and links to RadioRA 2 through Clear Connect.™ The second employs a HVAC controller, wireless temperature sensor, and seeTemp™ decorator style wall controller. A stylish hybrid of these two methods is to use the TouchPro™ and the seeTemp™ together. No matter which method is used all are controllable from Lutron's iPhone and iPad application.

LULRHVLVHVAC	RadioRA 2 TouchPro™ thermostat	281.02
LULRDWSTF*	RadioRA 2 seeTemp™ 110VAC wall controller, no HVAC wiring needed	124.28
LULRHVAC1WH	RadioRA 2 HVAC controller	217.95
LULRF2TWRB*	RadioRA 2 wireless temperature sensor	74.94
LULRHVACPKGWH	RadioRA 2 HVAC package includes LULRDWSTFWH, LULRHVAC1WH, and LULRF2TWRBSW	374.08

* Available in 26 different colors



LULRHVLVHVAC

LULRHVAC1WH

LULRDWSTF*
LULRF2TWRB*

Lutron provides wired relay outputs to control HVAC equipment.



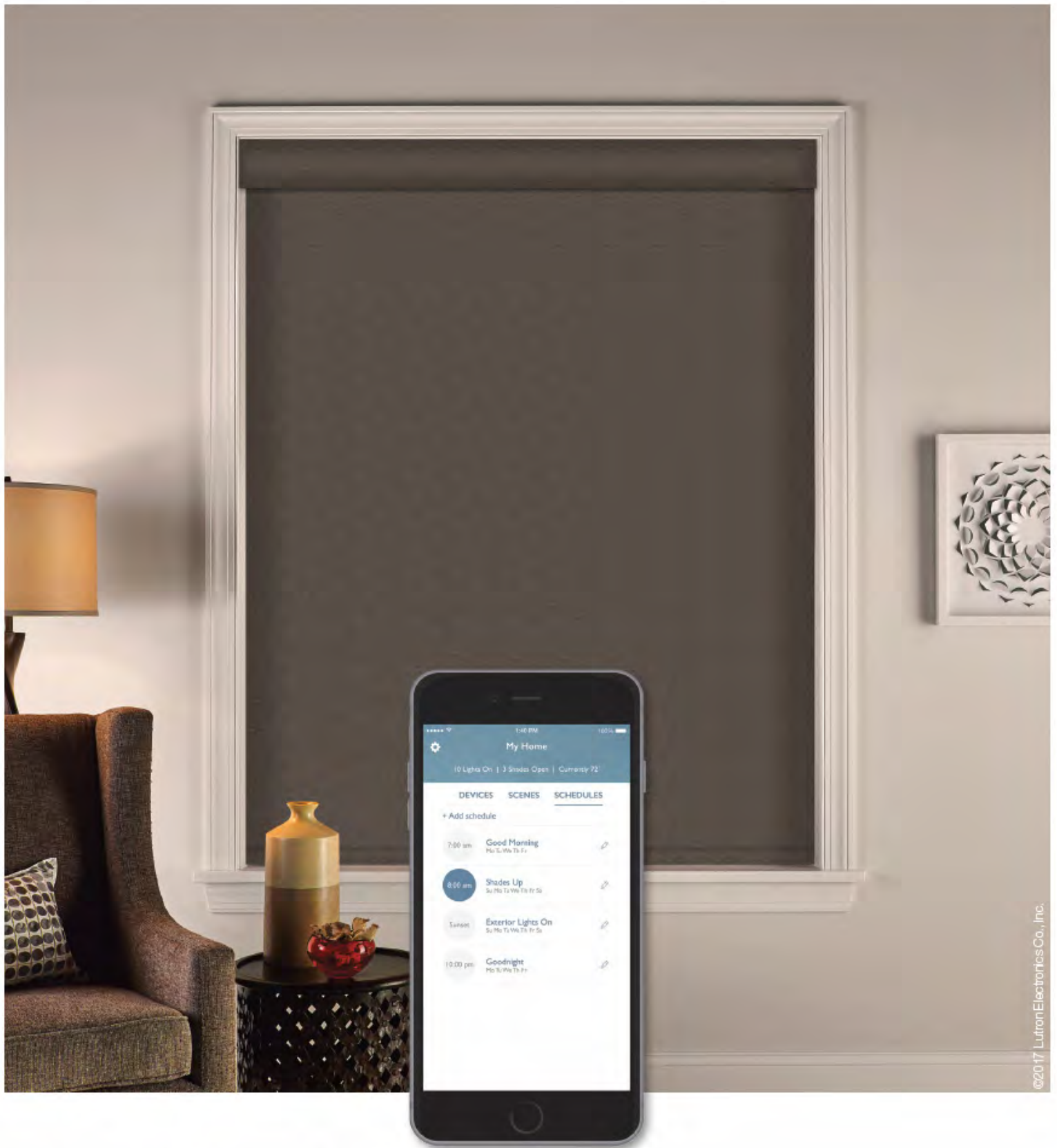

©2017 Lutron Electronics Co., Inc.

When beauty meets technology

Lutron intelligent shades automatically adjust when you want them to. Whether it's morning, evening, or somewhere in between, our shades provide unparalleled convenience and comfort. Ask your local Representative or visit lutron.com/triathlon for more information.



Color Option Samples



With RadioRA 2 you have a large color pallet to choose from along with matching wallplates. Gloss options are traditional colors which work with nearly all other devices in the home. For applications where the customer is looking for that extra touch, look to the Satin Color™ choices. These custom

colors allow wall devices to match the decor and room surfaces. The result will please even the most discerning tastes.

LUSCCK1	Sample Satin Color keychain	18.74
LUSCFD1	Sample Satin Color palette	6.24
LUDGCK1	Sample Designer Gloss keychain	18.74

RadioRA 2 Dimmer and Switch Color Change Kits

LURKD**/††	Dimmer color change kit	9.37
LURKD10**/††	Dimmer color change kit, 10-pack	84.31
LURKS**/††	Switch color change kit	9.37
LURKS10**/††	Switch color change kit, 10-pack	84.31
LURKAD**/††	Remote dimmer color change kit	9.37
LURKAD10**/††	Remote dimmer color change kit, 10-pack	84.31
LURKAS**/††	Remote switch color change kit	9.37
LURKAS10**/††	Remote switch color change kit, 10-pack	84.31

††-Gloss: WH-White, IV-Ivory, AL-Almond, LA-Light Almond, GR-Gray, BR-Brown, BL-Black

**-Satin: HT-Hot, MR-Merlot, PL-Plum, TQ-Turquoise, TP-Taupe, ES-Eggshell, BI-Biscuit, SW-Snow, PD-Palladium, MN-Midnight, SI-Sienna, TC-Terracotta, GB-Greenbriar, BG-Bluestone, MS-Mocha Stone, GS-Goldstone, DS-Desert Stone, ST-Stone, LS-Limestone



LUCW1BL



LUCW2SS



LULWTGSI

Claro Designer Gloss Wallplates

LUCW1††	Claro 1-gang screwless wallplate	3.12
LUCW2††	Claro 2-gang screwless wallplate	6.24
LUCW3††	Claro 3-gang screwless wallplate	9.49

4, 5, and 6 gang wallplates available

Satin Wallplates

LUSC1**	Satin 1-gang screwless wallplate	5.68
LUSC2**	Satin 2-gang screwless wallplate	8.87
LUSC3**	Satin 3-gang screwless wallplate	11.99

4, 5, and 6 gang wallplates available

Grafik T Wallplates

LULWTG**	Grafik T 1-gang plastic wallplate	11.99
----------	-----------------------------------	-------

2, 3, and 4 gang wallplates available.
Call for information on glass wallplates.

Stainless Steel Wallplates

LUCW1SS	Claro 1-gang screwless stainless steel wallplate	7.37
LUCW2SS	Claro 2-gang screwless stainless steel wallplate	13.61
LUCW3SS	Claro 3-gang screwless stainless steel wallplate	19.86
LUCW4SS	Claro 4-gang screwless stainless steel wallplate	25.60

Power Modules and Synthetic Loads

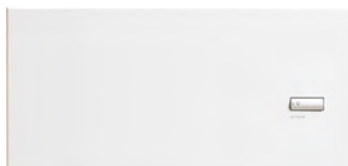

LULQRJWPM6P

The Wallbox Power Module can control 6 loads independently. The WPM is designed to be placed in closets, equipment rooms, and other locations where it is hidden from view. Homeowners use keypads or the Lutron HomeControl+ App to control the WPM. Level 2 Certification required.



LUPHPMPADVWH

LULQRJWPM6P	RadioRA 2 Wallbox Power Module. 120V 2000W. 6 load dimming module. Fits in 4-gang box.	524.58
LULMJ16RDVB	RadioRA 2 RF Softswitch Module. 16A 120/277V relay module. Fits in junction box.	93.05
LULMJCCO124B	RadioRA 2 RF Contact Closure Output module. Fits in junction box.	61.83
LULMJ5TDVB	RadioRA 2 RF 0-10V module. Fits in junction box.	124.28
LUPHPMPA120WH	Phase-adaptive power module 120V 16A. Fits in 2-gang box.	206.08
LUPHPMPADVWH	Phase-adaptive power module 120-277V 16A. Fits in 2-gang box.	287.27
LUPHPMSWDVWH	Switching power module 120-277V 16A. Fits in 2-gang box.	162.37
LULUTLBXWH	Synthetic minimum load. Used when a dimmer or switch's minimum load cannot be met.	93.68



LULMJ16RDVB

Modules can be mounted inside or outside a junction box on 1/2" NPT knockout

GRAFIK Eye QS Wireless



LUQSGRJ6PTWH



LUQSGRJ6PWH

For an easy and efficient way to control both electric light and daylight, look to GRAFIK Eye QS. Fully customizable, GRAFIK Eye QS adjusts lights and shades for any task or activity at the touch of a button. You'll save energy while meeting the aesthetic, functional, and regulatory needs of any project or space.

LUQSGRJ4PWH	4-zone GRAFIK Eye QS, white cover	693.20
LUQSGRJ4PTWH	4-zone GRAFIK Eye QS, translucent cover	693.20
LUQSGRJ6PWH	6-zone GRAFIK Eye QS, white cover	793.12
LUQSGRJ6PTWH	6-zone GRAFIK Eye QS, translucent cover	793.12

For other color options visit Lutron.com

Sivoia QS Triathlon

Automated Window Treatments

Sivoia QS Triathlon is one of the most fashionable, flexible, and affordable automated shading systems available today. This battery-powered solution offers an industry leading battery life for easy installation and maintenance, perfect for retrofit applications. Available in roller shade or insulating honeycomb styles, these shades have a wide variety of beautiful fabric colors and textures to meet the functional and aesthetic needs of any space. Able to work as a standalone or a system solution, these shades can be controlled at the touch of a button.



Adjust shades with a wire-free handheld or wall-mounted control from anywhere in the home. Shades can be controlled from the simplest Pico wireless remote to a smart phone. All of Lutron's controls are ultra-reliable and intuitive to understand. The Triathlon shading solutions easily integrate with RadioRA 2 lighting for full control anywhere in the world! RadioRA 2 keypads can be used to control shades and lighting loads at the same time.



Pico Wireless Remote
10 Year Battery Life!



RadioRA 2 Keypad

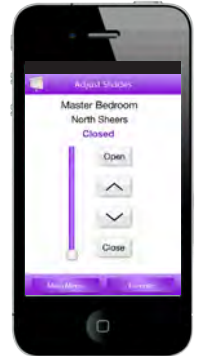

HomeControl + App

Install Shades in 15 Minutes

Installation of roller or honeycomb shades is simple. The only tools you'll need are a tape measure and drill. Visit www.worthington.com to view a video of how easy it is to install a Triathlon automated window treatment!

Opportunity

Lutron Triathlon automated shades offer a simple scalable way to offer precision natural light control. If you are installing a dimmer to control artificial light, why not control natural light? There are approximately 500,000 new homes built every year compared to over 100 million existing homes. This can be a perfect lead-in to call back existing clients for retrofit applications.

Are you offering automated window treatments as part of your installation?
Starting at only \$285!

- \$4 Billion Industry
- 100 Million Existing Homes
- Excellent for wireless retrofit
- Perfect for new hard-wired installations
- Easy way to increase revenue
- Scalable for any application

Applications

Lutron Triathlon shades are perfect for these applications and more!



- Windows behind a bathtub
- Commercial offices
- Whole house residential
- Home theaters
- Every RadioRA 2 installation
- Hard-to-reach windows
- Any retrofit where pulling wire is difficult
- Stairwell windows
- Glass or French doors

Specialty Applications

Give us a call for specialty applications that are outside of a standard window treatment.

- Angled windows
- Bottom-up roller and honeycomb shades
- Custom printed graphics
- Custom colors
- Arched windows
- Silhouettes
- Dual roller shades
- Draperies
- Roman shades
- Curved drapes

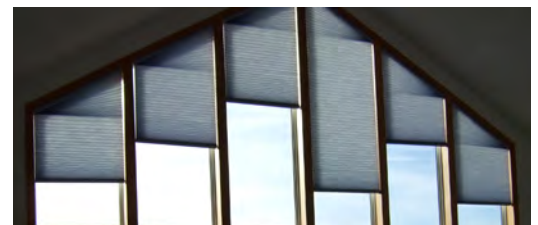

3 to 5 Year Battery Life

Battery replacement is easy!

Lutron's exclusive Tap n' Tilt technology allows almost anyone to change batteries every 3-5 years.

Permanent power solutions are also available.



Simply press the release buttons, allowing the headrail to tilt forward

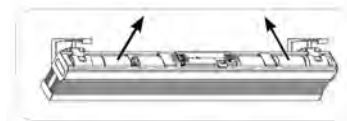

Change the batteries...



And snap the headrail back in place.

1-800-282-8864 (Phone)
www.worthdist.com

WORTHINGTON
 DISTRIBUTION

1-866-542-0470 (Fax)
sales@worthdist.com

Honeycomb Fabrics

Triathlon Honeycomb Insulating Shades have three different types, with various color choices within each. Each fabric allows a different amount of light to enter a room while providing energy saving insulation and privacy. Honeycomb Insulating Shades can double the R-value of a triple-pane window!



Light-Filtering Single Cell



Light-Filtering Double Cell



Room Darkening Single Cell

Software

Easily keep track of all your jobs with the Lutron Shade Configuration Tool!



Online Certification

- Step 1: Register with lutron.learn.com
- Step 2: Complete online training
- Step 3: Purchase a roller and honeycomb binder along with your choice of either the roller OR honeycomb demo kit.

Roller Fabrics

There are three families of fabric for Triathlon Roller Shades: Blackout, Translucent, and Sheer. Each fabric allows a different amount of light to enter a room while providing varied levels of privacy. Large 8"x10" samples are easily removed from the binder, simply add a suction cup to hang the sample on the window and a customer can easily determine which choice is best.

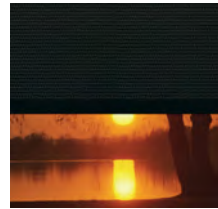

Blackout

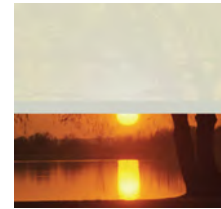

Translucent



Sheer

Triathlon WIDR

The Triathlon WIDR series of shades offers a wider, taller, longer battery life shade up to 12' x 12"! These shades also can employ Lutron's new Battery Boost option, enhancing battery life up to 80%. Triathlon WIDR shades are available as a standalone or system solution.



**12 ft. X 12 ft.
D-Cell Battery-
Powered Shades!**

**Give us a call today
to learn more.
1-800-282-8864**

Fabric Choice Is Simple!

Fabric selection has never been easier with the use of Lutron's fabric binders. There are color choices to match any decor. Typically the fabric binder is left with the customer for a few days to make a decision, similar to carpet samples.



LUROLLERBINDER	Complete roller fabric sample binder. Real fabric samples, all colors and styles included.	124.90
LUHONEYCOMBBIND	Complete honeycomb fabric sample binder. Real fabric samples, all colors and styles included.	93.68

Demonstration Sales Equipment

The Lutron shade demonstration kit is truly one of the finest pieces of demonstration equipment in the industry. It is a fully operational shade accompanied with a tabletop Pico controller. The shade is mounted within a stand-up tabletop window frame that easily collapses into an 8"x8"x36" black carrying case embroidered with the Lutron logo. Because the shade is battery-operated, it allows a simple demonstration anywhere, from your customer's kitchen table to a trade show booth.

Purchase the demo equipment from Worthington and receive \$50 off your first shade order!

LUHONEYCOMBDEMO	Portable tabletop honeycomb demonstration shade with Pico controller	499.00
LUROLLERDEMO-*	Portable tabletop roller demonstration shade with Pico controller	624.50

*Roller Demo Color - 1-Red, 2-Dark Gray, 3-Charcoal/Brown, 4-Twill, 5-Nutmeg



LUHONEYCOMBDEMO



LUROLLERDEMO



Shade In Bag



Collapsed



Folding



Open



Closed

Caséta™ Wireless

The Smart Way to a Connected Home
 Amazingly Simple. Amazingly Affordable.

Control your lights at home

Pico
Wireless Remote Control

In-Wall Dimmer
(No neutral) Switch available

Pico
Wireless Remote Control

Plug-In Lamp Dimmer

or anywhere

Amazingly Simple

1. Download FREE app.
2. No programming. Sets up in minutes.
3. Control and schedule your lights from anywhere.

Smart Bridge Pro and Smart Device



No New Wiring Required!

Retail prices shown below. Call for your dealer pricing today!

Starter Kits

LUPPKG1WWH	Caséta In-wall Light Dimmer with Pico	59.95
LUPPKG1PWH	Caséta Plug-in Lamp Dimmer with Pico	59.95
LUPBDGPKG2W	Smart Bridge Dimmer Kit with 2 600W dimmers, 2 Pico® Remotes, 2 single pedestals, 2 wallplates	189.95

Kits are available in white only

Dimmers and Switches

LUPD6WCL*	Caséta In-wall Dimmer. 150W LED/CFL, 600W incandescent/halogen. No neutral.	54.95
LUPD10NXD*	Caséta In-wall Dimmer. 250W LED/CFL, 1000W INC, HAL, MLV. Neutral optional.	98.00
LUPD5WSDV*	Caséta In-wall Switch. 600W incandescent/halogen, ELV, MLV, 5A LED/CFL. 3A fan. No neutral.	89.00
LUPD6ANS*	Caséta In-wall Switch. 720W incandescent/halogen, ELV, MLV, 6A LED/CFL. 3A fan. Neutral required.	64.95
LUPD3PCLWH	Caséta Plug-In Dimmer 300W Incandescent, 150W CFL or LED. Will act as a range extender	54.95

*Available in WH-White, LA-Light Almond, IV-Ivory, BL-Black

Control Multiple Locations

Caséta Wireless allows for more than control of a single device. A Pico remote control can be simply paired to control multiple dimmers or plug-in dimmers. Dimmers can also be easily paired with multiple Picos for his and her control of single or multiple devices.

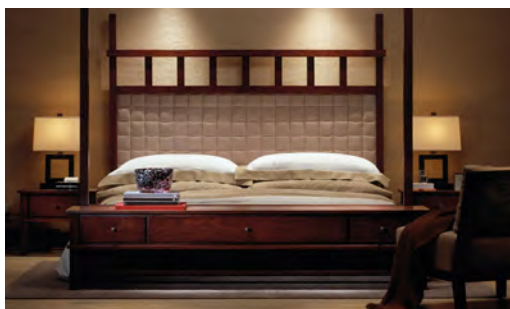

Caséta Smart Bridge

The Smart Bridge allows control of your Caséta lighting devices, temperature controls, and shades from a smartphone. Caséta utilizes ultra-reliable ClearConnect™ wireless technology. The Smart Bridge allows control via the Lutron app. The Smart Bridge Pro allows third-party integration such as Nest and control via the Lutron app.



Wireless Switch



Wireless Dimmer



Wireless Pico



LULBDGPRO2WH



LULHVLV2WIFI









LULBDG2WH	Caséta Smart Bridge	79.95
LULBDGPRO2WH	Caséta Smart Bridge Pro. For integration with third-party devices.	150.00
LULHVLV2WIFI	Lutron Wireless Thermostat	331.00

Pico Wireless Remote and Accessories

LUPJ2WALLWHL01	Pico Remote Control with Wallmount Kit	23.95
LUPJ23BRLGW*	Pico Remote Control	13.11
LUPICOWBXADAPT	Pico Wallplate Adapter Bracket	5.00
LULPED1*	Pico Pedestal Single Mount	9.37
LUPICOCARVISORC	Pico Car Visor Mount Clip	5.62

*Available in WH-White or BL-Black





Decora Wallplates

	White	Ivory	Light Almond	Ebony/Black	Brown	
	LEV80401-W	LEV80401-I	LEV80401-T	LEV80401-E	LEV80401	0.42
	LEV80409-W	LEV80409-I	LEV80409-T	LEV80409-E	LEV80409	0.85
	LEV80411-W	LEV80411-I	LEV80411-T	LEV80411-E	LEV80411	1.27
	LEV80412-W	LEV80412-I	LEV80412-T	LEV80412-E	LEV80412	5.17
	LEV80423-W	LEV80423-I	LEV80423-T	LEV80423-E	LEV80423	8.58
	LEV80436-W	LEV80436-I	LEV80436-T	LEV80436-E	LEV80436	10.75
	LEV80405-W	LEV80405-I	LEV80405-T	LEV80405-E	LEV80405	0.85
	LEV80421-W	LEV80421-I	LEV80421-T	LEV80421-E	LEV80421	2.54
	LEV80431-W	LEV80431-I	LEV80431-T	LEV80431-E	LEV80431	4.97







Decora Plus Screwless Wallplates

	LEV80301-SW	LEV80301-SI	LEV80301-ST	LEV80301-SE	LEV80301-SO	4.86
	LEV80309-SW	LEV80309-SI	LEV80309-ST	LEV80309-SE	LEV80309-SO	9.70
	LEV80311-SW	LEV80311-SI	LEV80311-ST	LEV80311-SE	LEV80311-SO	14.55
	LEV80312-SW	LEV80312-SI	LEV80312-ST	LEV80312-SE	LEV80312-SO	19.41

Decora Nylon Wallplates

	LEV80401-NW	LEV80401-NI	LEV80401-NT	LEV80401-NE	LEV80401-N0	0.52
	LEV80409-NW	LEV80409-NI	LEV80409-NT	LEV80409-NE	LEV80409-N0	1.06
	LEV80411-NW	LEV80411-NI	LEV80411-NT	N/A	LEV80411-N0	1.59
	LEV80412-NW	LEV80412-NI	LEV80412-NT	N/A	LEV80412-N0	5.17

Standard Wallplates

	LEV80701-W	LEV80701-I	LEV80701-T	LEV80701-E	LEV80701	0.31
	LEV80709-W	LEV80709-I	LEV80709-T	LEV80709-E	LEV80709	0.62
	LEV80703-W	LEV80703-I	LEV80703-T	LEV80703-E	LEV80703	0.31
	LEV80705-W	LEV80705-I	LEV80705-T	LEV80705-E	LEV80705	0.67
	LEV80414-W	LEV80414-I	LEV80414-T	LEV80414-E	LEV80414	2.72
	LEV88033	3-gang box mount blank plate for the 3-gang repeater box-White only				3.07

Give us a call about wallplate configurations that are not listed above.

Studio Series Decorator Wallplates



ONQWP5001-CY



ONQWP5002-CR



ONQWP5003-MS



ONQWP5004-BD

ONQWP5001-**	Single Gang	3.38
ONQWP5002-**	Two Gang	2.26
ONQWP5003-**	Three Gang	3.20
ONQWP5004-**	Four Gang	4.13

**Color - AL-Aloe, BD-Bordeaux, CP-Cameo Pink, CM-Cement, CR-Citrus, CZ-Cozumel, CY-Cyan, GB-Gloss Black, KK-Khaki, LA-Light Almond, MS-Moss, NV-Nirvana, SD-Sand, SP-Spanish Red, TP-Taupe, TI-Titanium, WH-White

For specialty plates, please refer to the manufacturer pages.

Powerline Control Systems offers two types of lighting controls: SimpleWorx™ and PulseWorx®

SimpleWorx is powered by SPC™ (Simple Powerline Communication), a rock-solid technology, while offering efficient solutions for remotely turning lights on and off. SPC provides super reliable one-way ON OFF control of lights and appliances using the 120v wiring that is already in place and offers a money back guarantee along with significant benefits above older powerline technologies or traditional wired and RF solutions.

SimpleWorx is a variety of transmitter and receiver devices, consisting of wire-in and plug-in, timers, keypads, switches, fixture and plug-in modules, which are super easy to install and set up. Pushing a button on each device is all that is needed to set-up your system. At last a really simple easy to install, and very reliable powerline lighting control product: One, two, three and you're done! SimpleWorx is a stand-alone simple-to-set-up lighting control like the X10 systems of the past. But better! Up to 5000' signal transmission without a coupler.

SimpleWorx Transmitter Modules

PCSSWX-DAT4	Digital Astronomical Timer, 16-event, 4-channel clock	109.91
PCSSWX-KPT4-*	Keypad Transmitter, wall-mount, 4-button, white or black	49.96
PCSSWX-DKT4-*	Desktop Keypad Transmitter, 4-button, white or black	69.94
PCSSWX-DST-*	Desktop Switch Transmitter, white or black	69.94
PCSSWX-FMT-AC	Fixture Module Transmitter - 120V input triggers signal	49.96
PCSSWX-FMT-CC	Fixture Module Transmitter - contact closure input triggers signal	49.96
PCSSWX-PMT-CC	Plug-In Module Transmitter - contact closure input triggers signal	59.95

PCSSWX-DAT4 PCSSWXWSXR15W

PCSSWX-DKT4-B PCSSWX-KPT4-B
SimpleWorx Transceiver Modules

This module will both send and receive SPC signals to control and be controlled

PCSSWXWSXR15*	Wall Switch Transceiver - 120V input w/10A load, 800watt incandescent	49.96
---------------	-----------------------------------------------------------------------	-------

*Specify W-White, I-Ivory, A-Almond (LA-Light Almond, B-Black, G-Gray, BR-Brown are special order)

SimpleWorx Receiver Modules

PCSSWX-RAM-15*	Receptacle Module, top controlled, 15A	49.96
PCSSWX-FMR-AC	Fixture Module Relay - 120V output, 20A max load	49.96
PCSSWX-PMR-AC	Plug-In Module Relay - 120V output, 15A max load	49.96
PCSSWX-PMR-CC	Plug-In Module Receiver - contact closure, 8A max load	59.95
PCSSWX-SST	Plug-In Sunrise Sunset Timer - Astronomical Clock, 10 presets, 15A max load	74.94
PCSSWX-RWS-*	Remote Wall Switch for 3-way or 4-way - Red LED	24.98

*Specify W-White, I-Ivory, A-Almond (LA-Light Almond, B-Black, G-Gray, BR-Brown are special order)

PCSSWX-FMR-AC

Integrate with UPB Lighting Control

PulseWorx® lighting controls are shown on the next page. They enable you to provide one-touch control over any of your home's lights via keypads, dimmers, switches, and plug-in receivers. All while working within the current framework, which already exists in any home. No new wires are required.

Utilizing UPB® technology, invented by PCS, the dimmers and keypads use the standard residential wiring (120/208/240V electrical system with a Neutral wire at each switch location) to control and create dramatic scenes without having to run additional wiring—providing an affordable, flexible lighting control option.

PulseWorx is modular, so you can start in one room and expand as your budget allows, along with your needs and wants. Installation is simple; attach or replace a switch with a PulseWorx wall switch or dimmer by connecting the switch's line, load, ground, and neutral wire (required) and you're ready to start creating lighting scenes like Good Morning, Dinner Time, Movie Time, Party, and Good Night from an installed keypad with just a few button presses.

Pulseworx can be used as a stand-alone system. It has been used very often with central controllers like the Leviton Omni or ELK M1. Full bi-directional communication not only simplifies programming but also provides verification of any UPB signal sent, further bolstering the system's capabilities.

Title 24 Timer

The T24 timer is a stand-alone multi-channel timer that can control, via relays or with relays and T24 commands, up to four circuits. The timer has a 2-line LCD display and a menu system where the basic functions of the timer can be configured. In addition, you can connect the timer to a USB or network connection and perform that configuration from the T24 software.

The timer has easy to use front panel controls. There is a row of four buttons, a row of 4 LEDs, and a second row of four buttons. There is a USB port for connecting the timer to a computer for setup using the T24 software. If the optional network board is installed there is a location to plug in a network cable.

PCST24-T4

- Four channels used for either outputs or inputs (Occupancy sensor, on/off switch, etc.)
- Output relays for 120VAC or 277VAC, 20Amp
- On/Off control or multi-level control using T24 0-10V Receiving Modules
- Schedules contain up to 250 timed events, four schedules, non-volatile memory
- Astronomical calculation of sunrise and sunset

PCST24-T4	Title 24 Timer - 4 Channel Timer	374.70
PCST24-RM	Receiving Module 0-10v - Title 24 Timer	35.97
PCST24-NA	Network Adapter - Title 24 Timer	124.90

1-800-282-8864 (Phone)
www.worthdist.com
WORTHINGTON
 DISTRIBUTION

1-866-542-0470 (Fax)
sales@worthdist.com

Universal Powerline Bus (UPB®) is a highly reliable, cost-effective, 2-way communication technology which enables control products to utilize existing powerlines for both residential and commercial applications. The award-winning UPB® technology was developed by Powerline Control Systems (PCS) and has been awarded several patents for its innovation.

Interfaces and Controllers

The PulseWorx Gateway (PGW) is the ultimate interface to any PulseWorx system that empowers the use of mobile devices, smart phones and/or tablets, to control the full line of PulseWorx/UPB products and will also communicate to all UPB licensee products.

PCSPGW	Pulseworx Gateway Interface. Control with mobile phones or tablets.	239.81
PCSTEC	Timed Event Controller, 20 timed events, serial control	149.88
PCSPIM-IP	UPB Powerline Interface Module-Ethernet program and control from a PC	199.84
PCSPIMR	UPB Powerline Serial Interface Module, control from a security or automation system	74.94
PCSPIMU	UPB Powerline Interface Module-USB program and control from a PC	74.94



PCSPGW

In-Wall Load Control Modules

PCSW1DL-6-*	600 watt / 5 Amp UPB wall switch/dimmer for incandescent and CFL/LED lights	74.69
PCSW1DL-10-*	1000 watt / 8 Amp UPB wall switch/dimmer for incandescent and CFL/LED lights	87.55
PCSW1DL-15-*	1500 watt UPB wall switch, single or 3-way, dimmer or switch (+ see note)	180.26
PCSW1DL-24-*	2400 watt UPB wall switch, single or 3-way, dimmer or switch (+ see note)	231.76
PCSW1R-15-*	Relay wall switch, 15A, single or 3-way, auto off timer	74.69
PCSRM1-15-*	Duplex Receptacle, top controlled, 15A	61.95

**PCSW1DL-6-W
PCSW1DL-10-W**



PCSRM1-15-W

PCSKPCW-7-W



PCSKPCW-6-W

*Specify W-White, B-Black, LA-Light Almond, (I-Ivory, A-Almond, G-Gray, BR-Brown are special order)

+Don't forget to order the matching wallplate when you order the high wattage dimmers (1500, 2400)

PulseWorx Controllers (Neutral Required)

PCSKPCW-6-*	Wall-mounted 6-button keypad, bright/dim and IR receiver	98.92
PCSKPCW-7-*	Wall-mounted 7-button keypad, bright/dim. Updated look!	158.87
PCSKPCW-8-*	Wall-mounted 8-button keypad, each button is programmable	98.92
PCSKPLD-6-*	Wall-mounted 6-button keypad with 400 watt load control, bright/dim	144.88
PCSKPLD-7-*	Wall-mounted 7-button keypad with 400 watt load control, bright/dim	184.85
PCSKPLD-8-*	Wall-mounted 8-button keypad with 400 watt load control, each button is programmable	144.88
PCSKPLR-6-*	Wall-mounted 6-button keypad with 10 amp relay, scene bright/dim	144.88
PCSKPLR-7-*	Wall-mounted 7-button keypad with 10 amp relay, scene bright/dim	184.85
PCSKPLR-8-*	Wall-mounted 8-button keypad with 10 amp relay; each button is programmable	144.88
PCSKPCD-6-*	PulseWorx Desktop Controller, 6-button, Blue backlights	124.90
PCSKPCD-7-*	PulseWorx Desktop Controller, 7-button, White backlights	174.86
PCSKPCD-8-*	PulseWorx Desktop Controller, 8-button, Blue backlights	124.90



PCSLM1-4



**PCSW1DL-15-W
PCSW1DL-24-W**

*Standard colors: W-White, B-Black, LA-Light Almond, (I-Ivory, A-Almond, G-Gray, BR-Brown are special order for 6 & 8-button only)

Load Control Modules

PCSFMD2-4	2-Channel Fixture Module Dimmer, 400 watt	89.93
PCSFMR1-20	PulseWorx Fixture Module Relay 1 channel, 20A	89.93
PCSLM1-4	Lamp Module, 1 channel, 400 watt, pass-thru	61.95
PCSAM1-12	Appliance Module, 1 channel, 12 Amp, pass-thru	61.95
PCSOCM	Output Control Module, 2 controlled relays	74.94
PCSICM	Input Module, 2 dry contact or low voltage inputs	74.94



PCSLDS-120V



PCSRM-0-10V



PCSKPLC-7-W



PCSW1C-W

0-10V Dimming

PCSW1C-*	Wall Switch-Relay/Dimmer-0-10V	94.67
PCSKPLC-7-*	7 Button Keypad w/ Load Relay, 8A, 0-10V	164.87
PCSRM-0-10V	PulseWorx - Receiving Module	18.98

Accessories

PCSPPC-1	Passive hardwired UPB Phase Coupler	49.96
PCSSPR-1	Split-phase Repeater, Omni Compatible	224.82
PCSTPR-120	3-Phase Repeater, Omni Compatible	324.74
PCSHLF-20	Powerline Wire-in Filter, 20 amps	236.81
PCSILC	In-Line Choke Filter	14.99

Accessories will ensure proper system operation when used correctly

Accessories for In-Wall Devices

PCSLDS-120V	LED Dimming Stabilizer, 15A	18.74
PCSILR-10K	In-line 10K Load Resistor, resolves LED issues	12.49
PCSRWS-*	Wired remote switch for 3- and 4-way circuits	24.98
PCSLCP-U	Lighting Control Panel	398.68

Universal Dimmer/Controller Bases

- Reliable UPB powerline communication
- Unique dimmer base design
- Keypads can control one or two loads
- Interchangeable faceplates allow the dealer to customize the button layout based on the customer's needs

Simply Brilliant™

SAUS2-40	900 watt switch/dimmer base. Req faceplate.	59.95
SAUS22-40	550 watt x2 switch/dimmer base. Req faceplate.	134.89
SAUS1-40	900 watt switch/dimmer base. Req faceplate.	52.46
SAUCQF	3-Speed fan controller base. Req faceplate..	67.45
SAUCQT-40A	Scene controller base. Requires ZS24BS or ZS24OS four button/LED faceplate.	56.20
SAZTP2*	Tabletop base & cord, accepts US240 base & faceplate (* Specify W-White, BK-Black)	18.74
SAUS2TP-W	Plug-in universal tabletop controller US240 base. Requires faceplate.	71.19
SAUSR-40A	Remote Switch Base with dual blue/green LEDs (for 3-and 4-way applications)	17.49



SAZS12-W



SAZS22-W



SAUS2-40



SAZS280-W



SAZS28B-W



SAZS250-W

Controller-Style Faceplates

For use with SAUS2-40, SAUS22-40, SAUCQF bases

SAZS24B-*	Quad 'Thin Bar' button faceplate	11.24
SAZS26B-*	Quad 'Thin Bar' button with 2 rocker faceplate	18.74
SAZS28B-*	Eight 'Thin Bar' button faceplate	18.74
SAZS24O-*	Quad 'Oval' button faceplate	11.24
SAZS25O-*	Quad 'Oval' button with 1 rocker faceplate	14.99
SAZS26O-*	Quad 'Oval' button with 2 rocker faceplate	18.74
SAZS28O-*	Eight 'Oval' button faceplate	18.74
SAZS24BS-*	Quad 'Thin' faceplate SAUCQT-40A & SAUCQF	18.74
SAZS24OS-*	Quad 'Oval' faceplate SAUCQT-40A & SAUCQF	18.74

* = Specify W-White, A-Almond, LA-Light Almond, I-Ivory, BK-Black, BN-Brown

Communication Control

SAUCS-01	UPB Controller, Scheduler, RS232	118.66
SAUMC-DB9-W	Plug-in Serial-UPB Power Line Interface Module, serial cable included - White	71.19
SAUMC-USB-W	Plug-in USB to UPB Power Line Interface Module, USB cable included - White	71.19

Rocker Style Faceplates

For use with SAUS2-40, SAUS22-40, SAUS1-40 bases

SAZS11-*	Single Rocker faceplate	3.33
SAZS12-*	Dual 'Tall' Rocker faceplate, for use with SAUS2-40, SAUS22-40 and SAUSR-40A bases	10.30
SAZS22-*	Dual 'Short' Rocker faceplate	10.30
SAZS23-*	Triple Rocker faceplate	14.99
SAZS24-*	Quad Rocker faceplate	18.74

* = Specify W-White, A-Almond, LA-Light Almond, I-Ivory, BK-Black, BN-Brown

Coupling and Repeating

SAZPCI-W	Inverted Coupler-Passive, wires to 220VAC circuit	52.46
SAZPCI-B	Inverted Coupler-Passive breaker mount, Compatible: Cutler-Hammer, Square D, Murray	52.46
SAZPCI-P30A	Inverted Coupler - Plugs into a 30 Amp, 220 VAC outlet (NEMA 10-30 configuration)	59.95
SAZPCI-P50A	Inverted Coupler - Plugs into a 50 Amp, 220 VAC outlet (NEMA 10-50 configuration)	59.95
SAUTR	UPB hard-wired Coupler/Repeater/PIM for 3-phase, serial DB-9 cable included	268.54

Load Control Modules

SAUML-E-W	2-Prong, plug-in, 300 watt UPB Lamp Module with local sensing - White	46.84
SAUML-20-W	3-Prong, plug-in, 400 watt UPB Lamp Module with local sensing, count-down timer and pass through outlet - White	56.20
SAUMA-E-W	2-Prong, plug-in 12 Amp UPB Appliance Module - White	46.84
SAUMA-20-W	3-Prong, plug-in 15 Amp UPB Appliance Module with local sensing, count-down timer and pass through outlet - White	56.20
SAUMI-32-W	Plug-in UPB I/O module, 3 input (4-5V AC/DC, 2 closure, 1 audio), 2 output (60V AC/DC) - White	71.19
SAUFR-30	UPB In-line 12 Amp Fixture Relay Module, built-in count-down timers - White	63.70
SAUFD-30	UPB In-line 300 watt Fixture Dimming Module, built-in count-down timers - White	63.70
SAURD-30-*	UPB top controlled outlet, 12 Amp, bottom on, built-in count-down timers (* Specify W-White, A-Almond, I-Ivory, LA-Light Almond)	71.19

Noise Filtering and Isolation

SAZNF10A-P	Plug-in 10 Amp, blocks noise above 4 kHz	22.48	SAZNF10A-W	Wire-in 10 Amp, blocks noise above 4 kHz	17.49
------------	------------------------------------------	-------	------------	------------------------------------------	-------

Simply Automated has two styles of lighting control to suit your needs.

First is "PC-Configured" UPB for Home Automation. This is the most versatile and allows you to custom program all your devices. Then you can integrate the system to a master automation system for control. "PC-Configured" UPB includes the devices on the opposite pages and the first section below.

Second is the "Anywhere Virtual Lighting." This is very simple to use for lighting as a stand-alone solution. This is a good option to replace some of those old X10 remote circuits. Configuring devices is simply button taps. These are in the bottom section of this page.

PC-Configured Complete Devices (Base and Faceplate Included)

The devices shown here and on the facing page are "PC-Configured" devices and require a Powerline Interface Module (PIM) or a programmer (UCS). The devices on this page are pre-assembled with base and faceplate plus they are programmed as a specific device. They are ready to install and configure in your UPB network. The Powerline Interface Module (PIM) options are available on the opposite page.

SAUCQF-W	UPB 3-Speed Fan Controller with white faceplate	76.81
SAUS11-40-W	UPB Wall Switch, single or 3-way, dimming or switching, 900 watt (requires neutral)	54.96
SAUSR1-40A-W	Complete Remote Switch (for 3- and 4-way applications)	22.48
SAUS28B40-W	UPB 8-button 'Bar Style' Switch/keypad, single or 3-way, dimming or switching, 900 watt	74.94
SAUS28O40-W	UPB 8-button 'Oval Style' Switch/keypad, single or 3-way, dimming or switching, 900 watt	74.94
SAUCQT-40A-W	UPB 4-button 'Oval Style' Scene Controller keypad w/4 status LEDs (no local output)	74.94
SAUS28OTP-*	Plug-in 8 oval button tabletop controller (* Specify W-White, BK-Black)	89.93
SAUSQT-*	Plug-in 4 oval button tabletop controller with 4 status LEDs (* W-White or BK-Black)	93.68



Anywhere Virtual Lighting Control

A simple, cost-effective alternative, versus running new wiring or using costly integration products.

Anywhere Virtual Remote Lighting Control Products and Accessories are configurable via push button only. The button chooses any 1 of 4 channels (except US2-V0, which have fixed transmit channels). Any number of units can be on each channel, so each switch rocker can control all units on that rocker's channel. The Anywhere switches replace existing mechanical wall switches (neutral required), utilize same wires of existing wall switches - no traveler wires or batteries needed! Turn on/off circuits from one or more switches and turn on/off any accessory. Transmits over one mile on a 12 AWG circuit.

SAV3WAY-A	Anywhere Virtual 3-Way On/Off Switch Kit, Single Rocker (2) US1-V0 900 Watt Anywhere On/Off Switches, white	53.71
SAV3WAY-B	Anywhere Virtual 3-Way On/Off Switch Kit, Dual Rocker (1) US2-V02 & (1) US1-V0 900 Watt Anywhere On/Off Switches, top-dual rocker controls US2-V02 local load/circuit, and bottom-dual rocker remotely controls US1-V0 local load/circuit. White	53.71
SAUS1-V0	Single Rocker Anywhere Virtual Accessory Switch, White	30.91
SAUS2-V02	Two Rocker Anywhere Virtual Accessory Switch, White	30.91
SAUS2-V03	Three Rocker Anywhere Virtual Accessory Switch, White	35.60
SAUS2-V04	Four Rocker Anywhere Virtual Accessory Switch, White	41.84
SAUMA-V0	Anywhere Virtual Appliance Relay Module, plug-in, 15A	29.98
SAUFR-V0	Anywhere Virtual Fixture Relay Module, wire-in, 12A	29.98
SAURD-30-*	Anywhere Virtual Controlled Receptacle, wire-in, 12A order color needed (W-White, I-Ivory, LA-Light Almond, or A-Almond)	71.19
SAUCS-V0	Anywhere Controller Scheduler-Timer	62.45

Color change on any SAUS1-V0 switch using any SAZS11 faceplate on page facing page

Prices shown are dealer prices



* Phase coupler may be needed when switches are on different phase circuits and phase alignment is not possible, especially if the home has more than 1 breaker panel or is greater than 2500 Sq. Ft.

SAZPCI-W	Inverted Coupler-Passive, wires to 220VAC circuit	52.46
SAZPCI-B	Inverted Coupler-Passive breaker mount, Compatible: Cutler-Hammer, Square D, Murray	52.46
SAZPCI-P30A	Inverted Coupler - Plugs into a 30 Amp, 220 VAC outlet (NEMA 10-30 configuration)	59.95
SAZPCI-P50A	Inverted Coupler - Plugs into a 50 Amp, 220 VAC outlet (NEMA 10-50 configuration)	59.95





Whole Home Lighting in the Bright Direction.



Affordable and Reliable Whole-Home Lighting Controls

Villa® Smart Home is the easy and affordable way to add lighting controls to your home or business. Perfect for new construction or retrofit applications, its benefits include an attractive switch design, user friendly app, energy savings, and an added touch of security. With energy costs increasing, automatically dimming and turning off unused lights can extend the life of your bulbs and lower your power bill.

Learn more and request a demo at VillaSmartHome.com

FEATURES

- Works with Alexa
- Supports up to 100 custom scenes
- ZigBee-based for the ultimate in reliability
- Flexible rules engine that runs locally. No worrying about internet outages!
- Remote dealer Login
- Compatible with 3-, 4-, and 5-way circuits
- Easy dealer installation
- Replaces existing in-wall switch
- Advance settings exclusive to Villa Smart Home



Villa - ZigBee HA Family of Devices

Villa® Smart Home is the easy and affordable way to add lighting controls to your home or business. Perfect for new construction or retrofit applications, its benefits include an attractive switch design, user friendly app, energy savings, and an added touch of security. With energy costs increasing, automatically dimming and turning off unused lights can extend the life of your bulbs and lower your power bill.

Villa Hub		
CL9410-C	Villa hub, ethernet port, 2 USB ports, battery backup (4x "AA" batteries provide up to 24 hours of backup)	161.12
Lighting Control		
CL3140-LC	1-button in-wall dimmer, 800W, Light Almond	44.96
CL3140-WC	1-button in-wall dimmer, 800W, White	44.96
CL3141-LC	3-button in-wall dimmer, 800W, Light Almond	74.94
CL3141-WC	3-button in-wall dimmer, 800W, White	74.94
CL3145-LC	1-button in-wall relay switch, 1000W, Light Almond	44.96
CL3145-WC	1-button in-wall relay switch, 1000W, White	44.96
CL3146-LC	3-button in-wall relay switch, 1000W, Light Almond	74.94
CL3146-WC	3-button in-wall relay switch, 1000W, White	74.94
CL3200-G	Appliance module, 12A	37.47
CL3420	Night light repeater. Multi-color, dimmable night light with built-in ZigBee repeater.	46.21

Sensors - Receive Notifications of Events with Villa Hub

CL3323-G	Micro door sensor, monitor door open/close	24.98
CL3328-G	Micro motion sensor, detect motion	28.73
CL3315-G	Water sensor, place on surface to monitor for leaks	33.72

Thermostats

CL3157100-BN	Pearl Thermostat, ZigBee HA, Black	106.16
CL3157100-SN	Pearl Thermostat, ZigBee HA, Black - Stainless Bezel	106.16
CL3157100-WN	Pearl Thermostat, ZigBee HA, White	106.16

- Supports over 100 devices
- Supports up to 100 custom scenes
- ZigBee based provides for the ultimate in reliability
- Flexible Rules Engine that runs locally. No worrying about internet outages!
- Remote Dealer Login
- Compatible with 3-, 4-, and 5-way circuits
- Easy dealer installation
- Replaces existing in-wall switch
- Advanced settings exclusive to Villa Smart Home

1-button dimmers, switches, and plug-in modules are directly controllable from an Amazon Echo Plus device.



Watch for more Villa supported products coming soon!

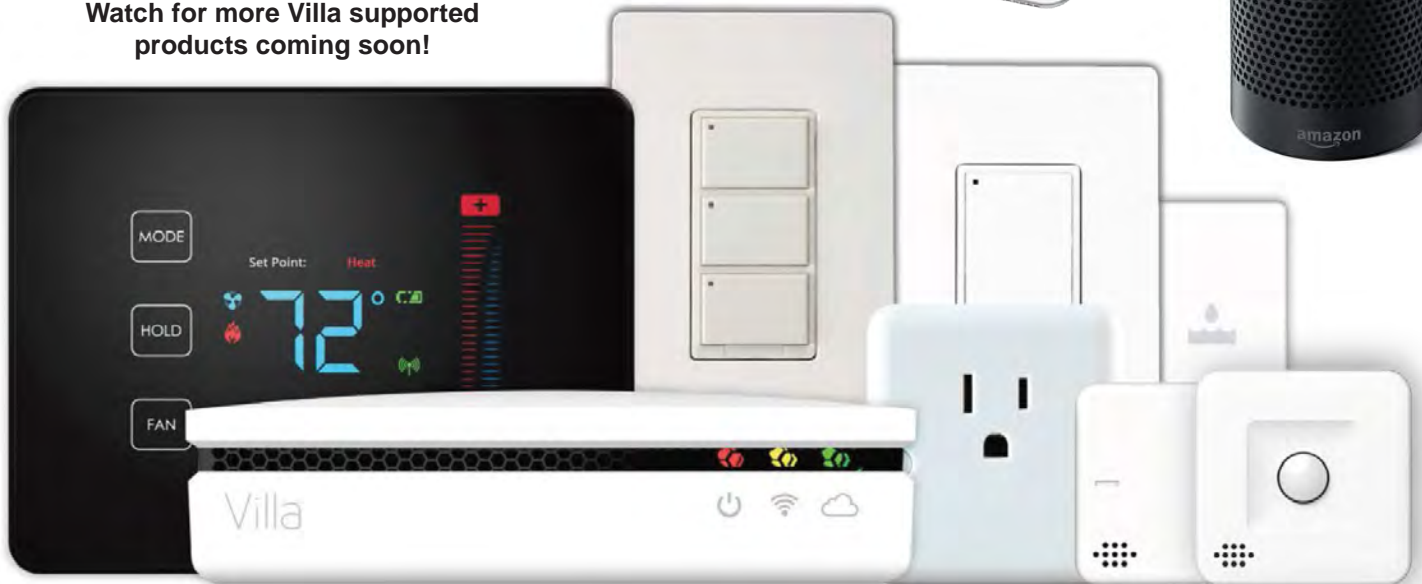

Centralite Villa Line of Products

JetStream - Wireless Lighting

Centralite JetStream products are still available for purchase when needed. Call for details.

Keypad Overview



Centralite offers a range of keypads which are sure to match your installation needs. Centralite's Traditional and Europa series are the original and most cost-effective options. From there the Ultra- and Mystique-Mercedes keypads offer a more elegant look and feel at a middle of the road price. Finally, we have the Finesse keypads which feature backlit, engravable buttons for the ultimate modern styling.

Worthington Distribution is Centralite's master distributor.

We have great stocking levels and provide technical support before and after the sale, so be sure to get your Centralite parts here!

Custom Button Engraving



Centralite keypads ship with blank buttons. Engraving is available at \$3.50 per button (\$25 minimum order). We recommend hand-labeling the blank buttons for your customer for the first 30 days or so until they are comfortable with them. At that point, the customer should know exactly which labels they would like. Engraving adds a professional touch to your work.

Finesse Premium Backlit Key pads

Order 1 Plate and 1 Assembly per complete keypad

CL1410101-(1,2,7)	Finesse 2-Button Keypad Plate	21.98
CL3412102-*	Finesse 2-Button Keypad Assembly	84.93
CL1410102-(1,2,7)	Finesse 4-Button Keypad Plate	21.98
CL3412104-*	Finesse 4-Button Keypad Assembly	84.93
CL1410103-(1,2,7)	Finesse 6-Button Keypad Plate	21.98
CL3412106-*	Finesse 6-Button Keypad Assembly	84.93
CL1410104-(1,2,7)	Finesse 8-Button Keypad Plate	21.98
CL3412108-*	Finesse 8-Button Keypad Assembly	84.93



CL1410104-7 & CL3412108-LL

With curved, back-lit buttons, Centralite's Finesse keypads put a modern twist on wall decor. Custom engraving on keypad buttons allows the back-light to show through the text, providing a stylish effect.

Plate Options: 1-Black, 2-White, 7-Light Almond
*Assembly Color Options: BW-Black Button/White Frame, BB-Black Frame/Button, WB-White Button/Black Frame, WW-White Frame/Button, BL-Black Button, Light Almond Frame, LB-Light Almond Button, Black Frame, LL-Light Almond Button/Frame

Traditional and Europa Key pads



CL3271002-A Europa

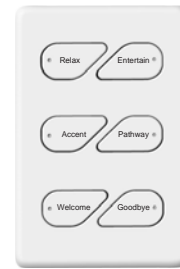

Both styles can be custom-engraved.



CL3382004-W Traditional

CL327#002-*	Europa 2-Button Keypad	21.98
CL327#004-*	Europa 4-Button Keypad	42.97
CL327#006-*	Europa 6-Button Keypad	64.95
CL3382001-†	Traditional 1-Button Keypad	23.08
CL3382002-†	Traditional 2-Button Keypad	33.57
CL3382003-†	Traditional 3-Button Keypad	45.06
CL3382004-†	Traditional 4-Button Keypad	56.65

*=A-Almond, B-Black, I-Ivory, LA-Light Almond, W-White
†=A-Almond, I-Ivory, LA-Light Almond, W-White
Call for alternative wiring and LED color options.
= 1- RJ45, 2-Screw Terminal

Ultra- and Mystique-Mercedes Key pads



CLULTS10606AAB2



CLMYSS10404AIG

CLULTS10202A*†2	Ultra Mercedes 2-Button Keypad	66.20
CLULTS10404A*†2	Ultra Mercedes 4-Button Keypad	83.68
CLULTS10606A*†2	Ultra Mercedes 6-Button Keypad	92.43
CLMYSS10101A*†	Mystique Mercedes 1-Button Keypad	79.94
CLMYSS10202A*†	Mystique Mercedes 2-Button Keypad	96.17
CLMYSS10303A*†	Mystique Mercedes 3-Button Keypad	111.16
CLMYSS10404A*†	Mystique Mercedes 4-Button Keypad	126.15

*W-White, I-Ivory, A-Almond, B-Black
†= LED color B-Blue, G-Green
Call us for additional wallplate assembly options.

App Controls

Looking to control your Elegance XL system on your smartphone or tablet? Check out these customizable solutions!



BitWise Controls - Page 35

Centralite Elegance XL - Reliable Hardwired Lighting Control

Hard-wired inputs and hard-wired outputs make for lightning-fast response times from keypad or RS-232 commands.

Reasons You Should Choose



Elegance™ XL

Elegance XL works with almost any lighting load: magnetic low voltage, LED, CFL, and small motor (e.g. bathroom fan) loads.

Avoid RF issues like transmission distance, large load counts, and metallic building materials.

Third-party integration via RS-232:



and more...

With five different styles of engravable keypads you can match your customer's tastes perfectly.

How to Specify an Elegance XL System:

1 Start with an MCP

A Master Control Panel and rough-in box is required for every Elegance XL system.

2 Add output modules

Up to 8 dimmer panels, LVRB, HVRB, or FSC boards are supported on each MCP.

3 Add SuperStars

Add enough SuperStar boards to cover the number of desired buttons.

4 Add keypads

A list of compatible Centralite keypads can be found on page 66.

System Components

CL3152096	MCP (Master Control Panel), one required per system, requires rough-in box, supports 192 loads	1,099.12
CL1252300	Rough-In Box for MCP, required to mount MCP	49.96
CL7252024	24 Load Dimmer Panel with SuperStar input, supports 24 lighting loads and 96 button inputs	1,748.60
CL7252024-NS	24 Load Dimmer Panel, supports 24 lighting loads	1,476.82



CL3152096

SuperStars (Keypad Inputs)

CL4152040	SuperStar Board Only, 96 button inputs, can mount in bottom half of CL7252024-NS	539.57
CL4252241	SuperStar mounted in enclosure, 96 total button inputs	649.48
CL4252202	STAR Pak, includes (2) STAR input boards mounted in enclosure, 48 total button inputs	419.66
CL4252203	STAR Pak, includes (3) STAR input boards mounted in enclosure, 72 total button inputs	554.56
CL4252204	STAR Pak, includes (4) STAR input boards mounted in enclosure, 96 total button inputs	689.45



CL7252024

System Options

CL3321005	Keychain Remote Kit, includes (2) remotes and a receiver, wires to SuperStar like a keypad button	124.90
CL1320500	Extra Keychain Remote, use with above kit	37.97
CL4152001	Fan Speed Controller (FSC), connect up to 4 ceiling fans, provides low/medium/high/off control	484.61
CL4252311	(1) Fan Speed Controller in enclosure	619.50
CL4252312	(2) Fan Speed Controllers in enclosure	1,074.14
CL3152080	Low Voltage Relay Board (LVRB), 16 relays, use for landscape lighting, window treatments, etc.	484.61
CL4252411	(1) Low Voltage Relay Board in enclosure	619.50
CL4252412	(2) Low Voltage Relay Boards in enclosure	1,074.14
CL3152070	High Voltage Relay Board (HVRB), 16 relays, great for motor loads, heavy loads, etc.	484.61
CL4252511	(1) High Voltage Relay Board in enclosure	619.50
CL4252512	(2) High Voltage Relay Boards in enclosure	1,074.14



CL4152001



CL3152080



CL3152070

Questions? Give Worthington a call today.

Luxul Hard-Wired Networking Products

Luxul is the leading innovator of simple-to-deploy professional grade IP networking solutions for use by custom installation professionals. Designed for use in both residential and commercial environments, the Luxul family offers a complete line of solutions that simplify network design and deployment, resulting in a scalable network that is both powerful and easy to install.

The top 4 reasons why Luxul is sold by Worthington Distribution:

- Simple installation and setup
- Products aren't sold through online retailers
- Lifetime dealer support
- Luxul's 3-year warranty

Stay connected
with Luxul's wired
networking products.

AV Series Switches
The Perfect Blend of Design and Functionality

- Specifically designed to integrate with rack-mount AV equipment
- Eliminates the installation issue of switches which have ports on the front and AV equipment which have Ethernet connections on the back
- Rear-facing RJ45 ports feature standard LED feedback
- Front-facing display shows port status with selectable blue or green LEDs

LUXAMS-4424P

Part Number	# Ports	POE	POE Ports	Managed	Stackable	Rack Mnt	Port Spd	Price
LUXAMS-4424P*	26	Yes	24	Yes	Yes	Yes	Gigabit	759.39
LUXAMS-2624P*	26	Yes	24	Yes	No	Yes	Gigabit	618.26
LUXAMS-1208P*	10	Yes	8	Yes	No	Yes	Gigabit	281.02
LUXAMS-2600*	26	No	-	Yes	No	Yes	Gigabit	393.44
LUXAGS-1024	24	No	-	No	No	Yes	Gigabit	197.34
LUXAGS-1016	16	No	-	No	No	Yes	Gigabit	141.14
LUXAGS-1008M	8	No	-	No	No	No	Gigabit	73.69

* HD video over IP compatible

Switches

Part Number	# Ports	POE	POE Ports	Managed	Stackable	Rack Mnt	Port Spd	Price
LUXXMS-7048P*	52	Yes	48	Yes	Yes	Yes	Gigabit	1,686.15
LUXXMS-5248P*	52	Yes	48	Yes	No	Yes	Gigabit	1,292.72
LUXXMS-2624P*	26	Yes	24	Yes	No	Yes	Gigabit	646.98
LUXXGS-1024S	24	No	-	No	No	Yes	Gigabit	168.59
LUXXFS-1816P	18	Yes	16	Yes	No	Yes	10/100	337.23
LUXXMS-1010P	10	Yes	8	Yes	No	Yes	Gigabit	224.82
LUXXFS-1084P	8	Yes	4	No	No	No	10/100	70.43
LUXXGS-1008	8	No	-	No	No	No	Gigabit	44.96
LUXXGS-1005	5	No	-	No	No	No	Gigabit	28.73

* HD video over IP compatible

LUXXMS-7048P

LUXXMS-2624P

Front

Rear
LUXXFS-1084P

LUXXGS-1008
Routers
Full-Featured, High-Performance Routers

Luxul's Epic series of Gigabit routers provide an optimal platform for setting up the ultimate residential or commercial network. They allow for up to 512 concurrent device routing entries. The Epic 4 routers also feature an intuitive interface with advanced management, including firewall, QoS, VLAN, VPN and other capabilities which ensure the optimal performance, scalability and security of your network.

**LUXABR-4500
LUXXBR-4500**

- Model LUXABR-4500 complements Luxul's AV Series switches and features the same configurable LEDs and ports on the back
- All units include rack-mount hardware and are 1 rack unit high

LUXABR-4500	Epic 4 Gigabit router - ports on back	197.34
LUXXBR-4500	Epic 4 Gigabit router - ports on front	197.34
LUXABR-5000	Epic 5 Gigabit Route - ports on back	298.51

Luxul Power Products
IP Controlled Power Distribution Units

Luxul's Power Distribution Units (PDUs) provide IP control of individual outlets, giving you the ability to do a hard reboot or power-cycle connected devices via remote management platforms such as Domotz, Ithij, or another third-party control system, all without rolling a truck. With intuitive setup and operation, pre-emptive problem notification and automatic problem resolution, Luxul PDUs ensure the most-possible system reliability and uptime.

LUXXPE-2500

LUXPDU-08

LUXXPE-2500	Single port PoE/PoE+ injector	30.91
LUXPDU-02	2-outlet IP-controlled PDU	134.89
LUXPDU-08	8-outlet IP-controlled PDU	237.31
LUXPDU-16	16-outlet IP-controlled PDU, 8 always on	362.21

Domotz Remote Management - It's Just Like You're On-Site

Luxul's Domotz Box Pro allows you to access your customer's network remotely to perform maintenance, get real-time system alerts, and provide remote tech support all without setting up a VPN.

Core Features

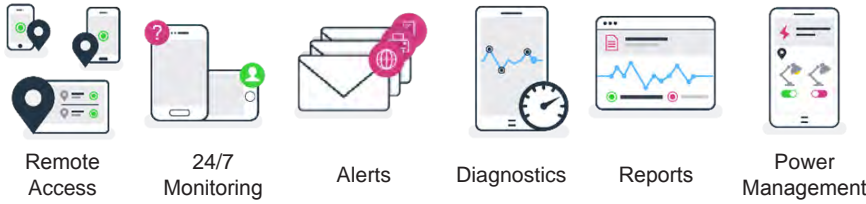

LUXXRM-DTZ1 Domotz Box Pro 187.35

LUXXRM-DTZ1

Wireless Access Point Controller and Kits

The Benefits of Wireless Access Point Management:

- Allows users to seamlessly roam without dropping connectivity
- Removes the burden of determining the best access point from your customers' mobile devices which improves performance
- Centralizes access point setup, making managing network settings easier



LUXXWS-2510



LUXXWS-1810

LUXXWC-1000	Wireless Controller, works with all Luxul APs, supports up to 16 access points	224.82
LUXXWS-2510	Kit - Wireless Controller with (2) XAP-1510 high-power access points	843.08
LUXXWS-1810	Kit - Wireless Controller with (2) XAP-810 standard-power access points	468.38

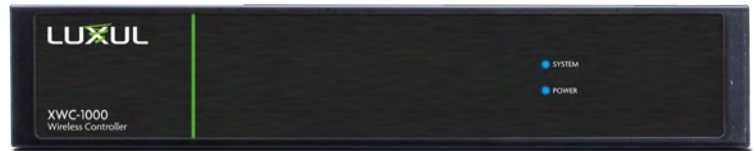

LUXXWC-1000

Wireless Access Points

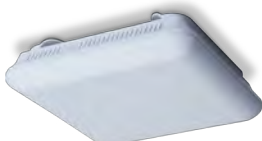

LUXXAP-1510



LUXXAP-810



LUXXAP-1440



LUXXAP-1240

Part Number	Coverage Range (max)	5GHz	2.4GHz	Max Clients	Roam Assist	Coverage Pattern	Price
LUXXAP-1510*	8000 ft ²	Yes	Yes	128	Yes	Omni	337.23
LUXXAP-1440†	1/4 mile	Yes	Yes	128	Yes	Omni	337.23
LUXXAP-1410*	8000 ft ²	Yes	Yes	128	Yes	Omni	247.30
LUXXAP-1240†	1/4 mile	No	Yes	50+	Yes	Directional	197.34
LUXXAP-810	2000 ft ²	No	Yes	20+	Yes	Omni	133.64

* 802.11ac with beamforming on 2.4GHz band, XAP-1510 on 5GHz band
† Outdoor-rated

Wireless Routers with AP Management

Luxul's XWR-3150 and XWR-1200 routers provide high-speed, concurrent dual-band Wi-Fi with the addition of their exclusive Roam Assist™ technology.

802.11ac wireless on concurrent 2.4 and 5GHz



LUXXWR-1200 LUXXWR-3150

Now with built-in control for up to two XAP models!

LUXXWR-1200	Dual-band wireless AC1200 router	123.65
LUXXWR-3150	EPIC 3 Dual-band wireless AC3100 router	247.30
LUXWS-100	XWR-1200 and XAP-1410 bundle	352.22
LUXWS-250	XWR-3150 and XAP-1510 bundle	555.80

Long-Range Wireless Bridging and Coverage

Shared Networking Without a Cable Run

Luxul's outdoor bridging modules provide connectivity to remote locations such as outbuildings or guest houses. They provide high-speed, dual-band Wi-Fi to anywhere within their "line-of-sight." This means you can share a network between two or more buildings up to two miles apart. Alternatively, the individual modules can be used as a long-range access point to provide Wi-Fi coverage to a large, open space.



LUXXWO-BKT1



LUXXWO-BAP1

Use the XWO-BAP1 to add another location for a point-to-multi-point bridging application or for long-range outdoor Wi-Fi coverage.

The XWO-BKT1 contains two point-to-point bridged modules. No configuration required!

LUXXWO-BAP1	Additional bridge module/outdoor access point	337.23
LUXXWO-BKT1	Pre-configured outdoor bridge kit	674.46

Luxul's wireless networking products have you covered.

USB Charger with Tamper-Resistant Receptacles

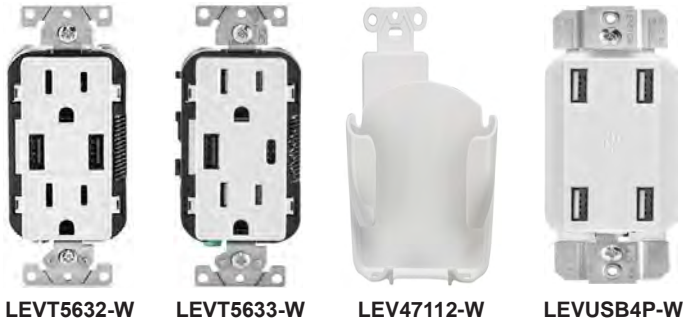

Leviton offers USB charging devices to fit into any application. 4-ports of USB charging, Type A x2, or Type A and Type-C mixed.

LEVT5632-*	3.6A Dual USB Charger with 120VAC Receptacle	23.88
LEVT5633-*	5.1A USB Charger with 120VAC Receptacle, 1x Type A and 1x Type-C	29.49
LEV47112-*	Decora Mobile Device Station	7.94
LEVUSB4P-*	4-Port USB Charger, 4.2 Amp, 25W, 125V	26.10
* Specify color: W-White, T-Light Almond, E-Black		

Rocker Slide Dimmers



LEVDL06-1LZ

LEVDSL06-1LZ	600W Incandescent, 300W LED/CFL, No Neutral	21.83
LEVDSM10-1LZ	1000W, 1000VA MLV, 450W LED/CFL, No Neutral	34.48
LEVDSSE06-10Z	300W LED/CFL, 600VA ELV, Single Pole/3-Way, Neutral Required	61.35

* W-White, I-Ivory, T-Light Almond
Color change kits available in W-White, I-Ivory, T-Light Almond, G-Gray, E-Black, B-Brown and R-Red

Bluetooth Dimmers and Switches



- Control manually using free iOS or Android App
- Local control within a 30-foot range
- Name your device
- Astrological timed events
- No other hardware needed



LEVDDL06-BLZ

LEVDDL06-BLZ	Bluetooth Dimmer, 600W Inc/Hal, 300W LED/CFL, No Neutral	36.28
LEVDDMX1-BLZ	Bluetooth Dimmer, 1000W Inc/Hal, 450W LED/CFL, MLV, Neutral Req.	48.21
LEVDDDE06-BLZ	Bluetooth Dimmer, 600W, 300W LED/CFL, ELV, Neutral Required	60.65
LEVDDDS15-BDZ	Bluetooth Switch, 1800W Inc/Hal, 600W LED/CFL, 15A, Neutral Required	45.61
LEVDDDF01-BLZ	Bluetooth Fan Speed Control, 1.5A, Neutral Required	40.02

Wall-Mount Devices with Built-In Night-Lights



LEVGFNL1-W

LEV6526-W

LEV6527-W

LEV6525-*	Decora Tamper-Resistant Receptacle with LED Guide Light, 15A-125VAC	7.87
LEVGFNL1-*	15A-125V Receptacle, Tamper-Resistant Duplex GFCI/Guide Light with LED indicator	22.98
LEV6526-*	Decora Single Pole Switch/LED Guide Light, 15A-120VAC, 1/2 HP	9.18
LEV6527-*	Decora Full LED Guide Light, 1W-120VAC	17.74
* Specify color: W-White, T-Light Almond, E-Black		

Humidity Sensor and Fan Control Wall Switch

The Leviton Humidity Sensor and Fan Control automatically detects excess humidity in a room and activates the ventilation fan to lessen condensation which helps reduce mold and mildew. The sensor also helps reduce energy usage by automatically operating the fan only when needed to control excess humidity.



LEVIPHS5-1LW

LEVIPHS5-1L*	Humidity Sensor and Fan Control - 600W Incandescent, 150W LED/CFL, 1/6 HP (3A) Fan	30.73
* Specify color: W-White, I-Ivory, T-Light Almond		

Toggle Slide Controls



LEVTSL06-W

Leviton's toggle style controls provide your customers with single pole and 3-way applications. This is a great touch for your traditional toggle controls as it has a separate ON/OFF toggle switch that preserves selected settings. This slim, compact device fits effortlessly into a standard wallbox.

Rated for CFLs and LEDs!

LEVTSL06-1L*	Toggle Slide Dimmer, 600W Incandescent/Halogen, 300W LED/CFL, No Neutral, Single Pole/3-Way, Locator Light	15.61
LEVTSM10-1L*	Toggle Slide Dimmer, 1000W Incandescent/Halogen, 400W LED/CFL, 1000VA MLV, No Neutral, Single Pole/3-Way, Locator Light	18.74
LEVTSF01-10*	20A-125V Receptacle, Tamper-Resistant Duplex GFCI/Guide Light with LED indicator	15.92

* Specify color: W-White, T-Light Almond, I-Ivory

Occupancy Sensors - Simple Lighting Automation

One of the simplest ways to offer your customers lighting automation is to use one of Leviton's occupancy sensors. Occupancy sensors add entry level automation where it is needed without adding the cost of whole home control by providing automatic ON/OFF switching of lighting loads for enhanced convenience, security and long-term energy savings. See the below examples for some of the most common uses of occupancy sensors.

Scenario #1 - Bathroom



LEVOSSNL-IDW

The Need: A way to provide light in a bathroom without your customer having to find a light switch in the middle of the night.

The Solution: A night-light wall switch occupancy sensor. This product can replace an existing light switch and provides a soft, low wattage LED light to allow your customer to safely find their way into the room at night.

LEVOSSNL-ID*	800W incandescent or 1200VA fluorescent, 180 degree view, auto on/off	47.74
LEVOSS10-INW	800W incandescent or 1200VA fluorescent, 180 degree view, manual on/auto off, Title 24	47.74

* Specify color: W-White, I-Ivory, T-Light Almond

We carry Leviton's full line of occupancy sensors, which are designed to fit a wide range of applications including outdoor and commercial installations.

Please call us for more information or for pre-sales design assistance (800) 282-8864.

Scenario #2 - Laundry Room



LEVODC0S-I1W

The Need: A way to turn on the light in a laundry room while your customer has a basket of laundry in their hands.

The Solution: A ceiling-mount self-contained sensor. This product will turn on the light when they enter the laundry room and will turn it off after they leave.

LEVODC0S-I1W	1000W incandescent or 1000VA fluorescent, 360-degree view, White	79.01
--------------	------------------------------------------------------------------	-------

Scenario #3 - Foyer

The Need: A way to conveniently ensure that your customer doesn't walk into an unlit home.

The Solution: A wall-mount occupancy or vacancy sensor mounted by the entrance way.

LEVIPS05-1LZ	5A relay occupancy sensor. Single pole, 180 degree view, 900 sq. ft. coverage.	25.98
LEVIPS15-1LZ	15A relay occupancy sensor. Single pole & 3-way, 180 degree view, 900 sq. ft. coverage.	28.09
LEVIPSD6-1LZ	Occupancy detector and dimmer. 180 degree view, Single Pole & 3-Way, 600 Watt Incandescent, 150W Dimmable LED & CFL.	31.47
LEVIPV05-1LZ	5A relay vacancy sensor. Single pole, 180 degree view, 900 sq. ft. coverage.	25.98

1LZ includes white, ivory, and light almond

EZ-MAX Commercial Lighting Control System by Leviton

Now you can offer simple energy management systems that pay for themselves, sometimes in as little as one year. If you're like many installers in our industry, your business has been affected by the economy. Although we focus on residential systems integration here at Worthington, our goal is to help you branch out into related areas of business that can help keep you in the black in these trying times. With energy costs on the rise, many commercial building managers are exploring energy saving options. Although residential energy management can be difficult to justify to a homeowner from a cost perspective, on the commercial side, energy management offers proven savings. EZ-MAX from Leviton is one of these products that our dealers have had success with. It's a flexible lighting control cabinet that lends itself to timer and dusk to dawn lighting applications and even area lighting when local keypads are attached. See the scenarios below for a better idea of where EZ-MAX is a good fit.

EZ-MAX Relay Panels and Relay Cards

LEVRELAY-L30	1-pole, NO/NC relay card, 30A, 120-277V	29.85
LEVRELAY-2PL	2-pole, NO relay card, 20A, 208-480V	40.51
LEVR08BD	8 Relay Panel only, no relays	510.63
LEVR08BD-L04	8 Relay Panel, (4) 30A NO/NC relays	655.11
LEVR08BD-L08	8 Relay Panel, (8) 30A NO/NC relays	787.23
LEVR08BD-208	8 Relay Panel, (8) 20A, 2-Pole NO relays	887.29

EZ-MAX Accessories

LEVPCOUT	Outdoor Photocell for EZ-MAX	174.86
LEVLVS-2W	2-button low-voltage switch	39.29
LEVLVS-5W	5-button low-voltage switch	39.29



LEVRELAY-2PL



LEVR08BD

Features:

- Easy programming using an offline editor or wizard-driven LCD display and oversized buttons
- Easy standard programming configuration
 - Occupancy sensors: manual-ON or auto-ON applications
 - Photocells: interior or exterior application modes
 - Photocell light level trip points: on or off
- Integrated astronomical time clock
- Time clock and scheduler
- Sunrise/sunset time clock events
- Integrated astronomical time clock
- Accepts input from momentary, maintained or toggle switches as well as low-voltage input from photocells and occupancy sensors for a comprehensive yet easily installed energy management solution

Scenario:

This could range from a small fabrication shop to a section of a large warehouse. EZ-MAX takes simple scheduling to the next level. Include wall-mounted low voltage switches to provide users with local control and add occupancy sensors for even more energy savings. EZ-MAX will evaluate the status of the schedule, switches, and sensors to determine the power state of a load for maximum energy savings.

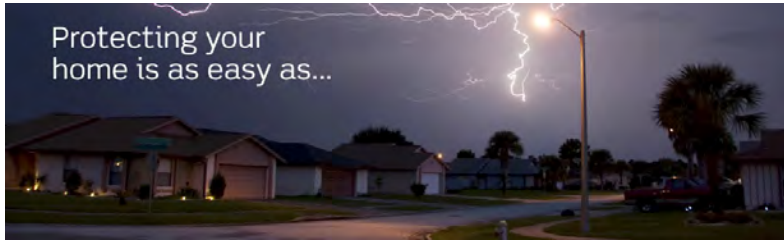

The Complete Surge Protection Solution

Protecting your home is as easy as...

Whole Home Surge Protection Starting at \$49.89!

A common misconception many homeowners have is that they can protect their home from dangerous lightning strikes and voltage surges simply by plugging their TV or computer into a power strip or just installing a surge protective panel. A power surge will travel through any wire into a house, leaving common appliances and sensitive electronic equipment vulnerable to serious damage.

To provide the most reliable protection, a whole house surge protection network is needed. A whole house surge protection network requires three types of surge protective devices at three levels within the home to effectively protect your electronic devices from the ruining effects of voltage surges.

Panel Mount Surge Protectors - Type 2

LEV51110-SRG

Installing a Type 2 panel-mount surge protector is an important step in preventing damage to your customer's expensive electronics. In most cases, a panel-mounted surge protector is the only defense against transient voltage for line voltage devices, such as automated lights. Any automated lighting installation isn't complete without some form of whole-house surge protection.

LEV51110-SRG	Panel-mounted surge protection for power, includes surface-mount brackets & flush-mount cover, 120/240VAC, 48kA max surge current rating, status line 1 & 2 with LEDs.	51.38
LEV51120-1	Panel-mounted surge protection device for power, 120/240VAC, status line 1 & 2 w/ LEDs, compatible with powerline carrier (PLC).	202.96
LEV32120-1	Panel-mounted surge protection device, 120/240VAC w/ LEDs, use with generators.	398.26

LEV51120-1
Secondary Surge Arresters - Type 1

LEV51120-3R

LEV55240-ASA

Typically mounted on the service side of the main service panel, Leviton's Type 1 SPDs prevent large, external transient spikes from entering into the home's electrical wiring. Listed models have a status LED so your customer can tell at a glance if their home is still protected.

LEV51120-3R	120/240V Single Phase Panel Protector in a NEMA 3R Enclosure	268.36
LEV55240-ASA	120/240V Parallel Wired Surge Arrester, NEMA 3R Rated	138.49

Point Surge Protection - Power Strips and Receptacles - Type 3

Protecting a circuit breaker panel may not be enough to stop a surge. Point-to-point surge protection is a must to feel confident that valuable electronic devices are protected.

Leviton's surge protection strips provide superior protection for everyday use in professional work areas and home offices, protecting computers, peripherals, and other electronic devices from damaging surges, voltage transients and noise spikes.

Part No.	Protects	Recommended App.	Note	Price
LEVS1000-PS	6 Outlets	Power	6 Standard Outlets	19.16
LEVS1000-PTC	6 Outlets	Power+Telco/Coax	6 Standard Outlets	24.26
LEVS2000-PS	9 Outlets	Power	6 Standard + 3 Wide Outlets	30.63
LEVS2000-PTC	9 Outlets	Power+Telco/Coax	6 Standard + 3 Wide Outlets	37.01
LEV5505-190	19" rack mount protector	12 receptacles	Breaker, switch & LEDs	95.07
LEV5280-*	Dual receptacle	Receptacle	Fault LED	32.17

* W-White, I-Ivory, B-Blue, GY-Grey, T-Light Almond, blank-Brown

For customers who worry about having bulky power strips or for installations where space is a concern, Leviton offers a line of surge protection receptacles. The low cost of these receptacles, combined with their ease of installation, means they can be placed anywhere you have a standard electrical outlet. So with a small investment, your customer can have the assurance that their equipment is well-protected. This is an excellent solution for recessed TV boxes, structured wiring cans, or a computer in a home office.

LEV5280-T

Protect your customer's valuable investment with Leviton surge receptacles!

LEVS2000-PTC

LEVS1000-PTC

LEV5505-190
Leviton's "True Whole-House Surge Protection" Limited Warranty

Service Entrance: Up to \$25,000 for Connected Equipment Limited Lifetime Product Replacement. This warranty is for the benefit of the original consumer purchaser only and will continue for as long as such original purchaser uses the Leviton Surge Protective Device stated within this warranty program.

Please visit www.leviton.com/warranty for full warranty details.

Green Power Surge and UPS



TRLBC350



TRLECO350UPS



TRLECO550UPS



What are Eco outlets?

Tripp-Lite's Eco outlets have the option to be configured to automatically turn off the outlets when the connected device is no longer drawing current. This helps to save energy with devices which are shut down or in sleep mode.



When the power goes out...



... how do you keep your cameras working?



Install an uninterruptible power supply (UPS)!



TRLECO650LCD



TRLTLP76MSG



TRLAV550SC

TRLBC350	UPS 350VA, 180 watts, 3 UPS outlets; 3 surge only outlets	50.58
TRLECO350UPS	UPS 350VA, 180 watts, 3 UPS outlets; 3 surge only outlets, 2 are designated Eco outlets	56.83
TRLECO550UPS	UPS 550VA, 300 watts, 4 UPS outlets; 4 surge only outlets, 3 are designated Eco outlets	76.19
TRLECO650LCD	UPS 650VA, 325 watts, 4 UPS outlets; 4 surge only outlets, 4 are designated Eco outlets	86.81
TRLTLP1210SATG	12 Outlet Surge, 2-line coax, 1-line RJ11/RJ45, Home/Business Theater Surge Suppressor	84.93
TRLTLP76MSG	6 individually controlled Eco outlets plus 1 always-on outlet, 1080 joules Home/Business Surge Suppressor	26.85
TRLAV550SC	Structured Wiring UPS 550VA, mounts in can or on a wall. Regulated 12VDC output for 4 devices, 4 110VAC outlets.	184.85

Worthington Distribution has access to Tripp-Lite's full line of UPS products. If you don't see a model on this page, call or email!

Rack Mount Power Conditioning



Rack Mount Uninterrupted Power Supplies

Looking for a UPS for your rack-mounted devices? Look no further than Middle Atlantic. The below prices are Middle Atlantic's Minimum Advertised Prices, so they are much higher than reseller pricing. Give us a call for a dealer quote, (800) 282-8864.



MAUPS-S500R

MAP
462.00

MAUPS-S500R	Select Series UPS Backup power, 1RU, 500VA, 6 outlets, 10 ft cord	462.00
MAUPS-S1000R	Select Series UPS Backup power, 1RU, 1000VA, 6 outlets, 10 ft cord	663.00
MAUPS-S1500R	Select Series UPS Backup power, 2RU, 1500VA, 8 outlets, 10 ft cord	771.00
MAUPS-S2200R	Select Series UPS Backup power, 2RU, 2200VA, 8 outlets, 10 ft cord	925.50

Middle Atlantic Series Protection Power Management and Distribution



MAPD-28-SP



MAPD-920R-SP



MAPD-415R-SP

MAPD-215	Two-stage compact, 2 outlet surge protector	135.00
MAPD-28-SP	Series Protection compact, 2 outlet surge protector	214.50
MAPD-915R-SP	Rackmount Power, 9 Outlet, 15A, 120 volt, Series Surge, 9 ft cord	471.00
MAPD-920R-SP	Rackmount Power, 9 Outlet, 20A, 120 volt, Series Surge, 9 ft cord	597.75
MAPD-415R-SP	Half Rackmount Power, 4 Outlet, 15A, 120 volt, Series Surge, 9 ft cord	275.25
MAPD-420R-SP	Half Rackmount Power, 4 Outlet, 20A, 120 volt, Series Surge, 9 ft cord	306.75

See pages 176 and 177 for other Middle Atlantic products, including IP-controlled outlets.

Middle Atlantic MAP prices are shown. Please call or login to the Dealer Store for aggressive dealer pricing.

Somfy Powers Smart Living

Inside & Out

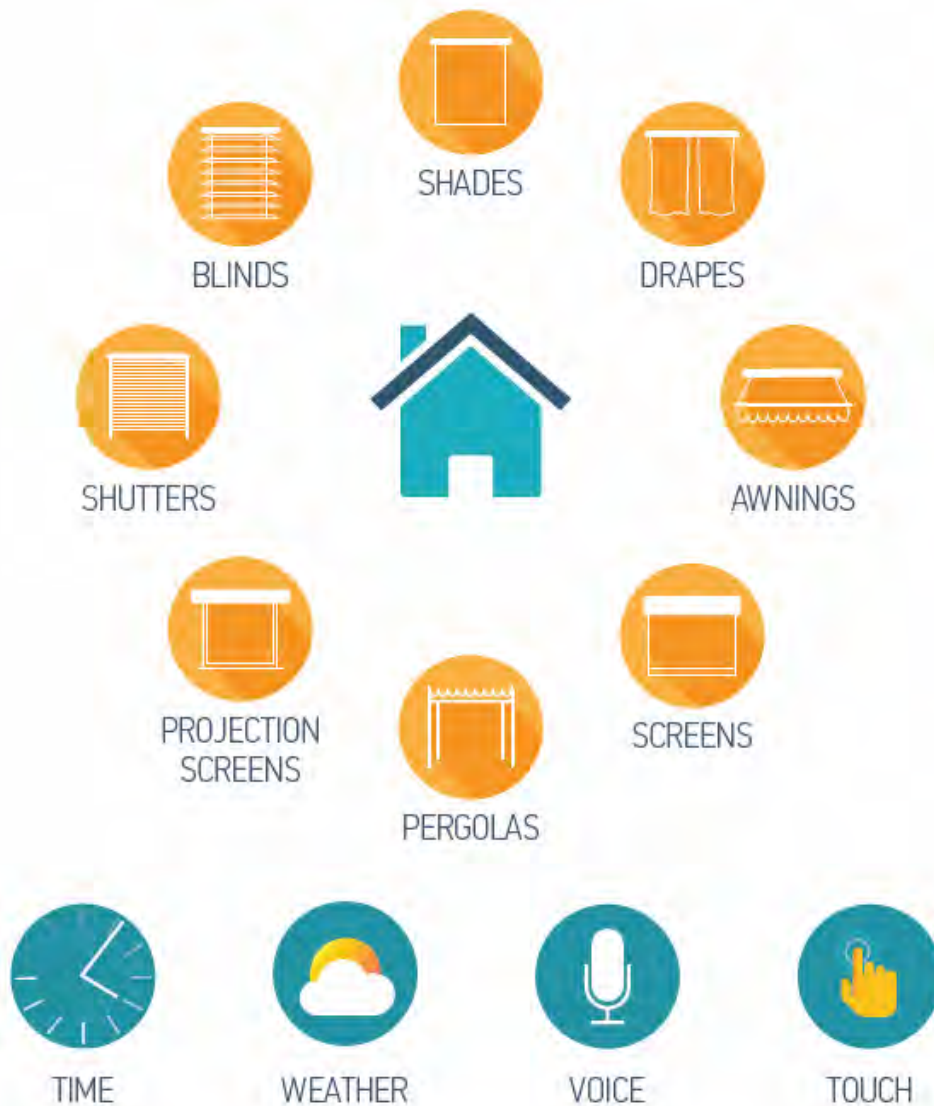

Somfy powers solutions for interior and exterior window coverings to increase privacy, energy savings, and convenience. Provide a richer automation experience featuring flexible control by integrating Somfy-powered solutions into third-party automation systems, regardless of brand or technology.

Visit us at www.somfysystems.com/Worthington

© Copyright Somfy Systems, Inc. 02/2018

somfy Building happiness

Worthington Distribution's Window Treatment Solutions

We offer a wide variety of automated solutions. From small, battery-powered roller shades hung in a hard-to-reach place to sun-blocking awnings for a patio, we carry it all. You can rely on our expertise to ensure that you get the right treatment, drive option, and controls to get your job done right. If you have any questions, please feel free to send an e-mail to shades@worthdist.com or call us at 1-800-282-8864.

Automated shading and control solutions by:



Window Treatment Video Series

Let a Worthington expert illustrate how easily treatments can be specified and ordered through Worthington Distribution. This video series walks you through each step of the process - from a basic overview of shading options all the way to ordering and installation.



Part 1: Overview



Part 2: Ease of Installation



Part 3: How to Sell Treatments

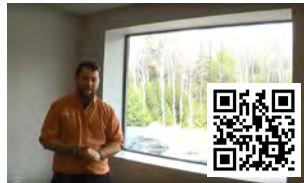

Part 4: How to Quote/Order

Check out our YouTube channel for these great videos as well as first hands-on reviews, intensive product overviews, and technical trainings.
www.youtube.com/worthingtondist

Window Treatment Video Series Overview

Part 1: Overview	Join Joel in our conference room for a demonstration of blackout shade materials versus light filtering materials followed by a brief introduction to Lutron's fabric binders.
Part 2: Ease of Installation	Tune in to see Joel and Nolan go head-to-head, installing a Lutron shading solution versus an in-wall dimmer. You may be surprised by the results!
Part 3: How to Sell Treatments	Check out this video to see some of the sales tools available to help sell Lutron shading solutions. This includes an in-depth review of Lutron's fabric binders and a walkthrough of Lutron's SCT software.
Part 4: How to Quote/Order	In the final part of our video series Joel covers the six pieces of information we need to properly quote a Lutron window treatment: measurement, inside/outside mounting, fabric information, which power option, additional hardware (such as a fascia), and finally a picture of the window.



Roller Shades
pages 56-57 and 76



Drapery Tracks
page 79

Worthington Distribution provides shading solutions for every installation - from a single-room home theater to an entire commercial complex.



Honeycomb Shades
pages 56-57 and 76



Exterior Shades/Awnings
page 76

Have shading questions?

Give us a call at (800) 282-8864 or e-mail shades@worthdist.com.

Sales Tools for Shading Solutions

Don't go to a shading sales pitch empty-handed.

Trying to explain automated shades or showing your customer a website just doesn't have the impact of a working demo or a fabric sample book. Setting up a demo shade and handing your customer the remote takes a few minutes, and you'll be amazed at how the shades will sell themselves. Once you've piqued their interest, let your customer explore their fabric options and they'll decide which fabric they'd like. You'll soon find that automated shades are one of the easiest things you can sell to your customers.

Somfy's Black Case demo kit includes an RTS roller or cellular shade, remote control, and over-the-door hooks. It allows you to quickly set up a working demonstration of Somfy's motors in action.

	Free shipping on Somfy demo products	SOMFY BLACK CASE	Portable over-door demonstration shade with RTS remote	249.00
		PRISTINE FABRIC BINDER	Roller shade fabric book for Pristine shades	35.00

Check out page 57 to see demo products for Lutron shading solutions.



Interior Treatments Powered by Somfy



When considering your options for motorized window treatments remember that Somfy's motorization provides the most flexibility in the industry. They offer three options for power: wireless battery as well as hard-wired low voltage and AC. Somfy also has a huge range of integration and control options.

Contact us for more details 800-282-8864

Pristine Roller Shade Pricing Example



For the pricing below we are going to assume the following:

- We're using the window on the right in this photo.
- It has been measured correctly, and the measurements are 35 7/8" wide by 58 1/4" high.
- The customer has chosen a Phifer SheerWeave 3000 fabric.
- We're using a 24VDC RTS motor.
- No fascia or side rails are required.

Sample Pricing	Dealer	MSRP
Fabric	67.91	126.00
Motor	418.26	776.00
Total	486.17	902.00

Dealer's Profit \$415.83!

Need to know how much you can make selling automated treatments on your next installation? Send your measurements to us and we'll respond with a quote within 48 hours.

Send quote requests to shades@worthdist.com

We Now Offer Cellular Shades with Somfy Motorization

You asked and we listened! Worthington Distribution now has cellular shading options using fabrics from Levolor Kirsch. Adding Somfy battery-powered motors to these treatments makes them the perfect fit for bathrooms or other hard-to-reach areas.



WireFree Rechargeable Motor



Designed for **Silence** and **Simplicity**

A wire-free motor with a built-in, rechargeable lithium-ion battery offers a convenient and quiet motorized solution for roller shades.

This is the only WireFree solution which uses Somfy's Sonesse - quiet motor technology.

On a full charge, the built-in Li-Ion battery lasts for approximately one year of normal operation before needing to be recharged.

Once the motor is ready to be charged, simply plug the charger into the charging whip which is installed on the motor.

A six-foot extension cable is available for charging the motor on taller or out-of-the-way treatments.

SOM1003128	Sonesse 30 WireFree (Li-Ion) RTS motor	144.21
SOM9020672	Plug-in charger for SOM1003128	11.00
SOM9020673	6' charger extension cable	2.93

See next page for compatible RTS controls

* Motor price will be included in quoted shade pricing.

Third-Party RTS Control Accessories



SOM1810872

SOM1810872	16-channel universal RTS interface (URTSI)	278.65
SOMHAICBL	6' cable, connects an Omni with the URTSI	9.99

Omni Speaks Somfy

With firmware versions 3.14 and later, Leviton Security & Automation's Omni Pro II, IIe, and LTe controllers natively speak the RS-485 needed to operate RTS motors via the Somfy URTSI.



Automated Exterior Treatments



Zip Screens

SunStopper's Zip Screen retractable shading system provides simple control for expanded outdoor living. The Zip Screen will reduce sun glare and heat, add privacy, and create a virtually bug-proof environment with its side-fabric-retention system.

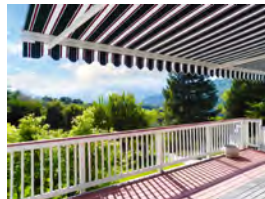

Motorized Awnings

Extended or retracted, SunStopper retractable awnings enhance the curb appeal of a home. It simply retracts back at the touch of a button with no unsightly poles left behind. It can be mounted on a wall, under a soffit, or onto a roof.



Exterior Roller Shades

In addition to adding privacy, exterior solar shading solutions are even more effective than interior mounted shades at reducing heating and cooling costs. By affecting room temperatures up to 20 degrees it can reduce these costs by as much as 40 percent.

Exterior Shading Solutions



Make Worthington Distribution Your Integration Experts

Worthington Distribution has been in the automated shading business for over a decade. Give us a call or send us an email with any questions or to request a quote. We have the knowledge and resources to make your next integrated shading job successful.

Call us
(800) 282-8864
or email shades@worthdist.com

Somfy myLink™

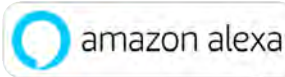

Control Treatments powered by Somfy with your voice!

The Somfy myLink can be controlled with Alexa by Amazon. This gives you the ability to open and close shades without the need for an RTS remote or using the app on your smartphone.

App available on iOS and Android!

Shade Control and Automation, No Hub Required

Simply plug-in your myLink, open the Somfy app, and follow the on-screen prompts to pair it with your existing shades and Wi-Fi. The app allows local and remote control as well as automation, including sunrise/sunset actions.

SOM1811403 myLink RTS smartphone and tablet interface 265.33

Smoove® RTS Wall Switch



Intuitive, Surface-mounted Control

- 1-channel controller
- Surface-mounts on the wall
- Colored frames sold separately

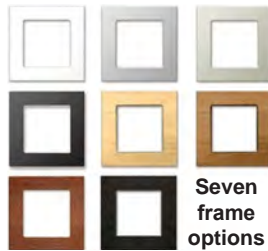

Seven frame options

SOM1811533

SOM1811533	1-channel Smoove surface-mount switch, white	69.00
SOM9015025	Smoove frame, silver matte	7.00
SOM9015027	Smoove frame, light bamboo	23.00

Other RTS Transmitters and Automation Accessories



SOM1810633	SOM1810813	SOM1805237	SOM9013708
SOM1810632	1-channel Telis Pure remote	56.36	
SOM1810633	4-channel plus all-channel Telis Pure remote	73.17	
SOM1811081	16-channel Telis Pure remote	233.39	
SOM1810813	DecoFlex 5-channel wireless in-wall controller	137.92	
SOM1810791	RTS repeater. Limit one per system.	189.64	
SOM9013707	Sunis indoor RTS transmitter: Open/close 1 RTS channel based on light level	202.97	
SOM9013708	Thermo Sunis indoor RTS transmitter: Same as SOM9013707, but adds temperature sensing.	233.39	
SOM1805237	Chronis Pure RTS timer. Weekday/weekend scheduler. Program up to two events (one up/one down command) per day.	185.32	

Somfy Connect Universal Automation Interface Plus

Simplified third-party integration

The Somfy Connect™ Universal Automation Interface Plus (UAI Plus) offers a single point of communication between third party automation systems and Somfy Digital Network™ 2.0 (SDN 2.0) motorized shading systems. Simply plug the UAI Plus into Ethernet and your SDN power supply or data panel and then select the UAI Plus from Network Devices on your Windows computer. The GUI will guide you from there.



SOM1870272

SOM1870272 Somfy Universal Automation Interface Plus 665.32

SDN Bus Distribution Components

Redefining smart wired motors.

Forget what you knew about Somfy's ILT motors. SDN 2.0 keeps what was great about ILT, individual or group control and two-way feedback, but makes project planning and implementation so much simpler.

- Segments can be up to 4000' via Cat5, no RS-485 terminations needed
- Red/green LEDs on each panel and hub indicates proper wiring
- Power units (PUs) help determine maximum node count



SOM1870260



SOM1870261



SOM1870262



SOM1870259

SOM1822440	SDN bus power supply, provides power to a single segment or sun sensor	756.74
SOM1870260	SDN data panel, supports four segments	156.36
SOM1870261	SDN extender, adds a branching segment to an existing segment	113.16
SOM1870262	SDN data hub, splits data to up to five devices up to 200' from data hub	1,138.66
SOM1870259	SDN power panel for up to 10 low voltage motors and two keypads	1,474.60

SDN Keypads



SOM1811252



SOM1811253

SOM1811252	6-button SDN Decoflex keypad, white	129.81
SOM1811253	8-button SDN Decoflex keypad, white	140.12

Don't see a part you need?
Worthington Distribution carries Somfy's entire line of motors and motor accessories. Contact us for pricing and availability.





Case

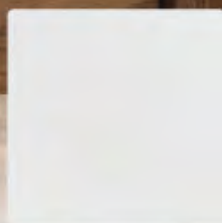

Wall Station



Base Station

LUXEPORT

The next level of iPad charging and mounting.



Refined
Aesthetics



Flexible
Installation



A Home
for iPad

Glydea® and Irismo™ Motorized Drapery Tracks

Motorized draperies add distinction to any living space and are great for home theaters, too. Somfy's Glydea® and Irismo™ are the most innovative motorized drapery solution available today. This powerful yet quiet solution, featuring flexible power options, will elevate your experience with motorized draperies so that you can effortlessly create a comfortable and convenient interior space.



Have questions about Somfy drapery tracks or do you need pricing? Give us a call at (800) 282-8864 or email shades@worthdist.com for answers or to request a quote.

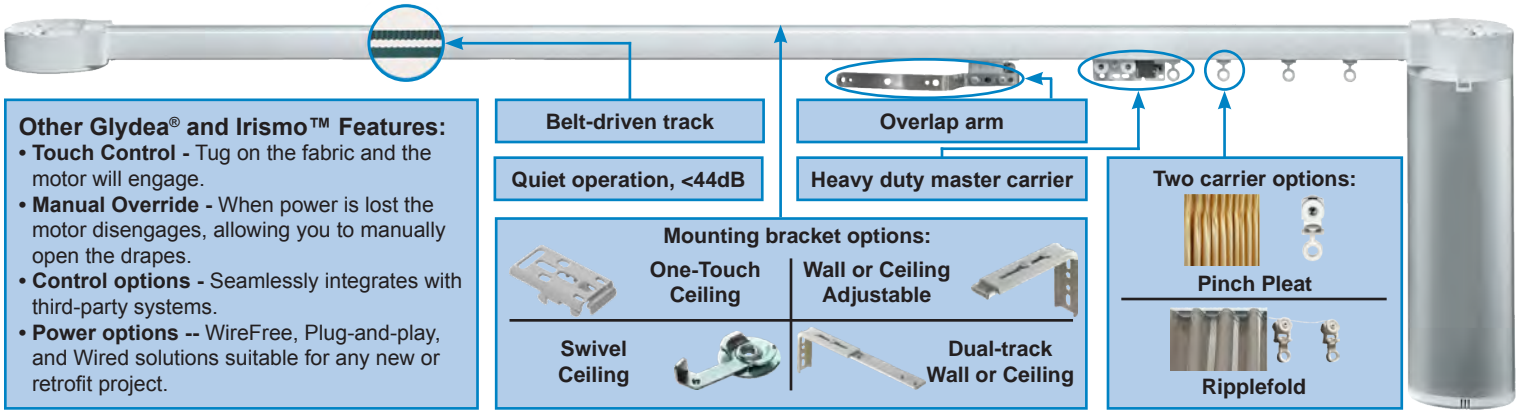

- Other Glydea® and Irismo™ Features:**
- **Touch Control** - Tug on the fabric and the motor will engage.
 - **Manual Override** - When power is lost the motor disengages, allowing you to manually open the drapes.
 - **Control options** - Seamlessly integrates with third-party systems.
 - **Power options** -- WireFree, Plug-and-play, and Wired solutions suitable for any new or retrofit project.

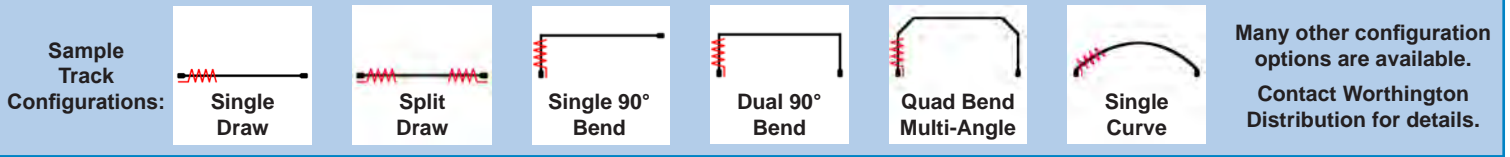

Glydea Control Options

RTS 	SDN (RS-485) 	Contact Closure 	Z-Wave or ZigBee
----------------	-------------------------	----------------------------	-----------------------------

Glydea Options and Accessories

SOM9014999	Charge for custom curving/bending, per bend	106.09
SOM9019872	Special packaging charge, per track	106.66
Glydea Limit Setting		
SOM9014599	Limit tool for the Glydea drapery motor. Required for any non-RTS motorized drapery	29.71
SOM9015443	Cable for use with SOM9014599, Glydea motors	7.80

Irismo 45 WireFree Drapery Tracks

Now There's a Fully Wireless Drapery Track from Somfy!
Utilizing a rechargeable lithium-ion battery and their flexible RTS controls, Somfy's Irismo provides a truly WireFree drapery track.

- Irismo 45 Features/Benefits:**
- Compatible with Glydea hardware - tracks, carriers, and brackets
 - Can run on a single charge for up to 9 months
 - Rated to carry up to 99 pounds of fabric and track lengths to 33 feet
 - Irismo 45 systems are easy to specify, install and operate

Irismo 45 WireFree Track Configurations:

Irismo 45 Power Accessories

SOM1002945	Charger for Irismo 45 batteries	68.57
SOM9019741	Additional battery pack for Irismo 45 motor	227.74

Glydea Sample Pricing

For the pricing below we are going to assume the following:

- We're using the sliding glass door in this photo.
- Its width has been measured correctly, and is 138 5/8" wide.
- This will be a left-drawn drapery.
- The customer will be installing a pinch pleat drapery.
- We're using RTS controls.
- The track will be wall-mounted.

Sample Pricing	Dealer	MSRP
Track, carriers, and motor	475.57	915.00
Brackets	20.66	39.75
Total	496.23	954.75

Dealer's Profit \$458.52!

Need to know how much you can make selling motorized treatments on your next installation? Send your measurements to us and we'll respond with a quote within 48 hours.

Send quote requests to shades@worthdist.com



Add intelligent controls to dumb motors...

ESI's RP60 and RQ60-series motor controls basically do one thing - they convert almost any standard AC or DC limit-switch motor into a smart motor.

Meet ESI's RP60 motor controls.

RP60 motor controls are one of ESI's longest-selling product ranges. They provide smart control of virtually any AC or DC standard motor. Although some of the RP60-series controllers have been discontinued and replaced by similar products in their RQ60-series, it's still important to have a knowledge of RP60 controllers since these same controls also work with the RQ60 controllers.

NOTE: To identify an RP60 controller check the "phone" jacks, any EYE, AUX, or BUS port will be grey.

RP60 Controller Features/Benefits:

- Adds intelligent control of standard motors from a contact closure, IR, RF, or serial input, see control options listed below
- Controller can be calibrated to a connected standard motor to learn the upper and lower limits allowing you to reliably move the motor to any percentage from 0-99%
- Two intermediate positions can be set to allow your customer to consistently move the motor to the same levels with a single button press
- Controllers can be programmed via a 24-channel remote/keypad or serially using the ESI GUI software, available for free from ESI's website

RP60 Motor Controllers in Plug-and-Play Plastic Boxes



ESIRP60ABMH	ESIRP60ABMH2	ESIRP60DBM4
ESIRP60ABMH	AC motor controller in plastic box	162.00
ESIRP60ABMH2	Dual AC motor controllers in a single box	174.66
ESIRP60DBM2	Dual DC motor controllers in a single box	172.12
ESIRP60DBM4	Four DC motor controllers in a single box	194.44
ESIRP60DBMSEQ	Sequential dual DC motor controllers	173.25

RP-Series Input and Control Options



ESIR2D7	ESIK24ST	ESIRR433	ESIT24S
ESIR2D7	RS-232 input module	98.81	
ESIK24ST	24-channel hard-wired keypad*	93.19	
ESIK24STRF433	24-channel RF keypad*	121.88	
ESIT24S	24-channel IR remote control*	52.88	
ESIT24SDUAL433	24-channel dual IR/RF remote control*	74.62	
ESIRR433	433MHz radio receiver	59.25	
ESIPSI-60	Programmable contact closure input board	43.12	
ESIPSIB	ESIPSI-60 in plug-and-play box	66.94	

* Also available in 1, 2, 6, and 12 channels at the same price

Introducing ESI's RQ60 motor controls.

RQ60 motor controllers build upon the RP60-series, both figuratively and literally. ESI's RQ60 motor controllers have all of the same features and can use the same input and control modules as the RP60 controllers while adding two-way RS-232 feedback and scene control, along with a few other features.

NOTE: To identify an RQ60 controller check the "phone" jacks, any QEYE, QAUX, or BUS port will be red and 8-BUS ports will be black.

RQ60 Controller Features/Benefits:

- Has all of the same features as RP60-series controllers
- Board-only models can be installed in ESI's custom panels
- Provides two-way RS-232 feedback via an RQ Bridge serial interface
- RQ control options can be programmed via the RQ Desktop Programmer software, available for free from ESI's website

RQ60 Single-Motor Controllers and Serial Bridge

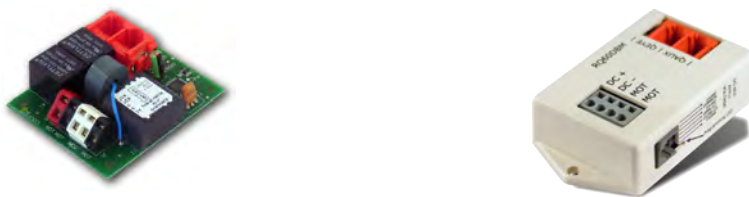

ESIRQ60AUMH115

ESIRQ60DBM



ESIRQ60DUM



ESISP2E2QB



ESIRQEXTENDER42

ESIRQ60AUMH115	Board-only 115VAC motor controller	136.50
ESIRQ60AUMHE230	Board-only 230VAC motor controller	136.50
ESIRQ60DBM	12-24VDC motor controller in plastic box	140.25
ESIRQ60DUM	Board-only 12-24VDC motor controller	112.50
ESIRQBRIDGE232	RS-232 serial module	78.75
ESISP2E2Q	2 Eye/2 Bus Splitter	19.50
ESISP2E2QB	2 Eye/2 Bus Splitter in Plastic Box	23.25
ESIRQEXTENDER23	50' RQ over Cat 5 Extender Kit	150.00
ESIRQEXTENDER42	1000' RQ over Cat 5 Extender Kit	182.35

RP Sun and Wind Controls



ESIPSSW

ESIDSKS/W

ESIWA

ESIPSSW	Programmable Sun/Wind Input Module	77.81
ESIDSKS/W	2-gang Decorator Sun/Wind User Interface	159.75
ESIWA	Wind Anemometer	42.75
ESILTSENINTV2	Indoor Light Sensor	22.95

... Or use motors with embedded intelligence.

ESI's M40Q and M50Q motors have RQ technology built right into the motor which eliminates the need for an extra controller and can reduce wiring costs.



RQ-Embedded Motors and Accessories

The M40Q and M50Q series motors are perfect for integrated installations in both commercial and residential applications.

RQ-Embedded Motors Features/Benefits:

- Embedded RQ and RP functionality
- Integrated manual inputs for use with dry contact switches



ESIM50Q634APS

ESIM40Q430APS	4 Nm 30 RPM RQ-embedded motor	300.75
ESIM40Q915APS	9 Nm 15 RPM RQ-embedded motor	300.75
ESIM50Q634APS	6 Nm 34 RPM RQ-embedded motor	270.75
ESIM50Q1234APS	12 Nm 34 RPM RQ-embedded motor	215.83
ESIPCM4050UNIV	6 foot unterminated power cord	13.50
ESIPCM4050US	6 foot power cord, grounded plug	14.25
ESIPCM40506MPL	18 foot plenum-rated power cord	39.00

ESI UL-Listed Custom and Open Panels

Convenient terminals for power feed

Power/communication cables pre-wired

Available for AC or DC standard motors

Built to UL-325 standards

Automation accessories can be mounted inside of the panel

Controllers are programmed and labeled to the installer's specifications



ESI CUSTOM PANEL

Additional Features:

- **Turn-key motor control solution** - Just connect your input power, connect the controllers to the motors, and calibrate the controllers to the motors.
- **Saves hours in the field** - ESI powers and tests all of the connections in each panel prior to shipping to ensure that all of the connections are secure, removing many potential failure points during troubleshooting.

ESICUSTOMPANEL1	8" x 8" x 4" custom panel, max 4 devices	309.00
ESICUSTOMPANEL2	12" x 12" x 4" custom panel, max 8 devices	386.25
ESICUSTOMPANEL3	12" x 18" x 4" custom panel, max 10 devices	541.50
ESICUSTOMPANEL4	12" x 24" x 4" custom panel max 16 devices	633.00
ESICUSTOMPANEL5	18" x 24" x 4" custom panel max 24 devices	815.25

To determine custom panel pricing select the appropriately-sized panel above and add RQ60 board-only controllers from the previous page.

8P8C Components

EAI's 8P8C range has the same features as the RQ series, but uses industry standard RJ45 connectors with T568B wiring. Because these connectors are more common, you will save time before and during each job.

8P8C Products Features/Benefits:

- Compatible with all RP/RQ controls
- RJ45 connectors to save time/material costs
- Simplified labels to reduce confusion in the field



ESISPBRQMOTOR



ESICBL6FTQEQM8P

8P8C RQ Motor Accessories

ESISPBRQMOTOR	RQ Motor Splitter, labeled IN, MOTOR, and OUT	300.75
ESICBL1FTQEQM8P	1' 8P8C RQ Motor Communication Cable	270.75
ESICBL6FTQEQM8P	6' 8P8C RQ Motor Communication Cable	215.83



ESIRQ48X10115

This unit is mounted inside of a UL-listed metal enclosure and has connections for up to four, standard AC motors.

RQ4 8X10B 115 features/benefits:

- Provides bi-directional control and feedback for up to four motors.
- Only counts as a single node for RP or RQ device counts.
- Contact-closure control inputs for each motor.

Four-Motor RQ Controller

ESIRQ48X10115	4-motor Control Board, in 8" x 10" metal enclosure	300.75
---------------	----------------------------------------------------	--------



ESIRQBRIDGE8P



ESIRQSCNSWITCH



ESIRQMSTSWITCH



ESIQSIB

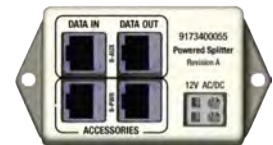

ESIPWRSPLITTER

8P8C Control and Power Options

ESIRQBRIDGE8P8C	RS-232 DB9 input/8P8C output module	116.25
ESIRQMSTSWITCH	Programmable RQ Master Switch, 3-button defaults as global Open, Close, and Stop	120.00
ESIRQSCNSWITCH	Programmable RQ Scene Switch, 7-button defaults as scenes A/a, B/b, C/c. and Stop	133.12
ESIQSIB	RQ contact-closure input module	73.29
ESIPWRSPLITTER	8P8C power injector/splitter module, use with any of the other modules listed above	73.29

The future never looked so bright.

A home was always meant to be a living environment – listening, responding, adapting to our every day; a reflection of who we are, and what we aspire to be. At Leviton, we create the technology that brings that relationship to life.



DECORA SMART™ WI-FI

Automate every home easily with a flexible cloud-based ecosystem that ensures comfort, safety, and lower energy bills – all controlled by a smartphone or tablet.



THE FUTURE IS ON®

LEVITON®

Floor Rings

Combining Sillites' self-contained receptacles with their floor rings is an inexpensive way to provide convenient power in wood, carpet, or tile floors.

Floor Ring Features/Benefits:

- Installs in minutes
- ETL tested to meet UL 514D standards when used with Sillites' self-contained receptacles
- Can support up to 300 pounds



SILFRAB	Floor ring, antique bronze	16.99
SILFRBN	Floor ring, brushed nickel	16.99

SILFRAB with SILSCRW

Sillites Candles



SILSL7BN

Add a touch of elegance with Sillites' direct plug-in candles. With Sillites, you totally eliminate the need for extension cords. Since the candles are available in two sizes, each with four different finishes, you're sure to find an option which matches your customer's décor.

SILSL7*	7" tall candle with lamp, drip cap, and white PVC sleeve (Made to order)	40.97
SILSL9*	9" tall candle with lamp, drip cap, and white PVC sleeve	40.97

* AB-Antique Bronze, PB-Polished Brass, BN-Brushed Nickel, MB-Matte Black

Replace the included white PVC sleeve with one of the below sleeves for a more traditional look for your Sillites candle.

SILGBS†	Golden beeswax sleeve for Sillites candle	9.09
SILIBS†	Ivory beeswax sleeve for Sillites candle	9.09

† 7 for 7" sleeve or 9 for 9" sleeve

Self-Contained Receptacles

Because Sillites' self-contained receptacles are UL listed, they can be used to supply power just about anywhere!



Inside of a window jamb to power automated treatments

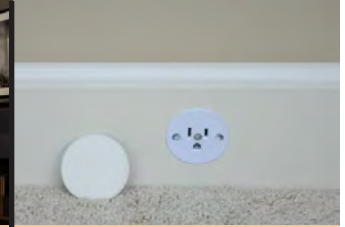

Unobtrusively through the moulding



On the side of cabinets to power kitchen gadgets



In the floor using an optional floor ring

SILSCRW	Self-contained receptacle, white, 125V, 15A & TR rated for use with 12/2 or 14/2 cables	12.94
SILSCRMB	Self-contained receptacle, black, 125V, 15A & TR rated for use with 12/2 or 14/2 cables	12.94
SILSCRBR	Self-contained receptacle, brown, 125V, 15A & TR rated for use with 12/2 or 14/2 cables	12.94



Self-Contained Receptacles

Use in Floors, Windows, Cabinets & Mantels

Direct Plug-in Window Candles

The Elegant Plug-In Candle for Your Window Sills



- NO J-BOX NEEDED!!
- For use with one or two 12/2 or 14/2 NM wire sections
- Tamper resistant
- Rated for 125 volt 15 amp operation
- Meets UL 498 and UL 514C with Floor Ring added
- Can be wired to GFI or arc fault breaker or receptacle
- Brown #SCRBR, Black #SCRMB, or White #SCRW

805 S. Glynn Street, Suite 127-345 • Fayetteville, GA 30214
Ph. 770-755-5654 • Fax 678-868-2440 • www.Sillites.com



Five Questions when Choosing an Omni Controller



1. How many security points or automation inputs will your installation require?

- Greater than 48 - OmniPro II
- 48 or less - Omni Ile, OmniPro II
- 16 hardwired (32 with wireless) or less - Omni LTE



2. Will you be connecting to a third party distributed audio system such as Russound, Xantech or Proficient?

- Yes - OmniPro II



3. How many thermostats will your project require?

- Greater than 4 - OmniPro II
- 4 or less - Any of the controllers



4. How much lighting will your project require?

- Greater than 64 loads/8 rooms - OmniPro II
- 64 loads/8 rooms or less - Omni Ile or OmniPro II
- 32 loads/4 rooms or less - Any controller



5a. Does your project require access readers?

- Greater than 4 readers - OmniPro II
- 4 or less - Omni Ile, Omni LTE

5b. Does your project require locks/maglocks/strikes?

- Greater than 4 - OmniPro II
- 4 or less - Omni Ile, Omni LTE

Connectivity Partners

Connectivity Partners	Products	Page
Access Control	Alarm Controls	Magnetic Locks, Door Strikes
	Seco-Larm	Deadbolts, Magnetic Locks, Door Strikes
Communicating Locks	August	Lock Pro with Z-Wave
	Kwikset & Baldwin	Deadbolts and Entry Sets: Z-Wave and ZigBee
	Schlage	Deadbolts and Entry Sets: Z-Wave
	Yale	Deadbolts and Entry Sets: Z-Wave and ZigBee
Interfaces	BitWise	A/V and Omni Control using Phones/Tablets
	GrandStream	Android Phones on IP Phone System
	HomeSeer	Integration with Amazon Echo (Alexa), Android/iOS App
Irrigation	Linear	Z-Wave Irrigation Controller
Large Load Control	Aeotec	Z-Wave 40 Amp Contactor
Lighting	CentraLite	Villa, 3-Series, Elegence XL
	GE and Jasco	Z-Wave Devices
	Leviton	Vizia rf +: Z-Wave
	Lutron	RadioRA 2
	PCS	Pulseworx
	Simply Automated	UPB Devices
Structured Wiring	Legrand	Enclosures, Modules, Power
	Leviton	Enclosures, Modules, Power
Temperature Control	2GIG	Z-Wave Thermostats
	MCO Home	
	Radio Thermostat	
	RCS Trane / Schlage	
Vehicle Detection	Cartell	Vehicle Detection Probes
	Dakota Alert	Hardwired and Wireless Sensors
Water Detection	GRI	Water Sensors
	Winland	WaterBug, EnviroAlert
Water Shutoff	GreenField Direct	KZValve
Whole House Audio	Russound	MCA-88, MCA-88X, MCA-66, CAA66, CAS44, CA4
Window Coverings	ESI	Motor Controls
	Somfy	Controls / Motors for window treatments featuring Z-Wave
	Lutron	Automated shades controlled by RadioRA 2 and Caseta
Wireless Networking	Luxul Wireless	Enhanced antenna solutions for Wi-Fi access points
Wireless Sensors	Alula	Wireless transmitters compatible with the LSA42A00-2 GE Receiver
	Ion	Wireless transmitters compatible with the LSA42A00-2 GE Receiver

Questions about compatibility? Looking for 5-Star Dealer Pricing? Give us a call today!

	Omni Pro II AUTOMATION	OMNI IIe AUTOMATION	OMNII Te AUTOMATION
Russound, Proficient, Xantech Audio Integration	Yes	No	No
Hi-Fi 2 Audio Integration	Yes	Yes	Yes
Communicating Thermostats	64	4	4
Inputs - On Board / With All Expansion	16 / 176	16 / 48	16 / 32
Voltage Outputs - On Board / With All Expansion	8 / 136	8 / 8	8 / 8
Consoles	16	8	4
Supported IP Touchscreens (5.7e, OmniTouch 7)	16	16	16
Serial Ports - On Board / With All Expansion	5 / 6	5 / 6	5 / 6
Flash Firmware Upgrade	Yes	Yes	Yes
Ethernet Port	Yes	Yes	Yes
2-Wire Smoke Loops *	4	4	4
User Codes	99	16	16
Access Control Cards / Keytags	99	16	16
Access Control Readers	16	4	4
ZigBee and Z-Wave Lock Support	16	4	4
Programming Lines	1500	500	300
Vocabulary	550	550	550
Custom Vocabulary	Yes	No	No
Maximum Auxiliary Current	1 Amp	1 Amp	1 Amp
Maximum Bell Current	1 Amp	1 Amp	1 Amp
UL Listed for Residential Burglary and Fire	Yes	Yes	Yes
Reporting Formats: Contact ID, 4/2, 3/1	Yes	Yes	Yes
Removable Terminal Strips	Yes	Yes	Yes
Warranty	3 years	2 years	2 years

Lighting Options and Capacities

UPB	Home Lighting Control (HLC)	31 Rooms**	8 Rooms**	4 Rooms**
	Simply Automated - Simply Brilliant	256 Addresses	64 Addresses	32 Addresses
	PCS - Pulseworx	256 Addresses	64 Addresses	32 Addresses
Z-Wave	Leviton - Vizia RF + (2-Way)	30 Rooms**	8 Rooms**	4 Rooms**
	Standard Z-Wave	232 Devices	64 Devices	32 Devices
Zigbee	Centralite - JetStream	200 Devices	64 Devices	32 Devices
	ZigBee Plug-In Modules	256 Addresses	64 Devices	32 Devices
Lutron	RadioRA 2	200 Devices	64 Devices	N/A
Hardwired	Omni-Bus	192 Devices	64 Devices	32 Devices
	KNX Interface	192 Devices	64 Devices	32 Devices
	Centralite Elegance XL	192 Devices	64 Devices	32 Devices

* Worthington recommends wiring for 4-wire smokes with Omni controllers starting on zones 5 and above.

** A Room = 8 devices. The controller tracks devices in a room and offers room status in addition to individual device status.

Take your Omni installation one step further with voice control using Alexa!



The HomeSeer Hometroller Zee is a home gateway that has a plug-in for Omni panels and also supports Amazon Alexa. The plug-in requires a purchase within the Homeseer interface. This setup will allow you to use Alexa to control anything on an Omni panel! All you will need is the HT-ZEE controller and an Alexa enabled interface (Echo/Echo Dot, etc.). Please see page 23 for more details.

OmniPro II

- "Go-To" Choice of Omni controllers
- Hi-Fi 2, Russound, Xantech, and Proficient Distributed Audio Support
- Integrated Ethernet port for connectivity
- Expandable for up to 176 security / automation points
- Plug and play with Omnistat thermostats
- Full support for numerous lighting systems
- Ethernet access using Snap-Link or PC Access
- Up to 6 serial ports for integration with third party systems



The OmniPro II offers the greatest number of third party drivers



LSA20A00-2***	OmniPro II controller in enclosure, RJ-31x, manuals, lock, keys, requires 7Ah battery, 24/40VA transformer	996.44
LSA20A00-8***	OmniPro II controller on a Leviton, Open House, Legrand, and UStec structured wiring plate, RJ-31x, manuals, wiring diagram decal, requires 7Ah battery, 24/40VA transformer	996.44
LSA20A00-5	OmniPro II commercial controller in an enclosure, RJ-31x, manuals, lock, keys, requires 7Ah battery, 24/40VA transformer	1,295.35
LSA20A00-21***	OmniPro II controller board only (order resistors separately), requires 7Ah battery, 24/40VA transformer	954.90

80 language options are available

Omni Ile

- The workhorse of the Omni family. Excellent value!
- Hi-Fi 2 Distributed Audio Support
- Integrated Ethernet port for connectivity
- Expandable for up to 48 security / automation points
- Plug and play with Omnistats
- Full support for numerous lighting systems
- Ethernet access using Snap-Link or PC Access
- Up to 6 serial ports for integration with third party systems

LSA20A00-50	Omni Ile controller in enclosure, RJ-31x, manuals, lock, keys, requires 7Ah battery, 24/40VA transformer	697.21
LSA20A00-52***	Omni Ile controller on a Leviton, Open House, OnQ, and UStec structured wiring plate, RJ-31x, manuals, wiring diagram decal, requires 7Ah battery, 24/40VA transformer	697.21
LSA20A00-53***	Omni Ile controller board only (order resistors separately), requires 7Ah battery, 24/40VA transformer	667.81

80 language options are available

Omni LTe

- Integrated Ethernet port for connectivity
- Hi-Fi 2 Distributed Audio Support
- Expandable for up to 32 security / automation points
- Plug and play with Omnistats
- Full support for numerous lighting systems
- Ethernet access using Snap-Link or PC Access
- Up to 6 serial ports for integration with third party systems

LSA20A00-70	Omni LTe controller in enclosure, RJ-31x, manuals, lock, keys, requires 7Ah battery, 24/40VA transformer	479.82
LSA20A00-72	Omni LTe controller on a Leviton, Open House, OnQ, and UStec structured wiring plate, RJ-31x, manuals, wiring diagram decal, requires 7Ah battery, 24/40VA transformer	453.62
LSA20A00-73	Omni LTe controller board only, requires 7Ah battery, 24/40VA transformer	407.70

Worthington Distribution Packages

LSAKIT15	OmniPro II in Enclosure Kit	1,249.99
OmniPro II controller in enclosure, 16 zone expander, surface-mount console, flush-mount kit, temperature sensor, serial cable, RJ-31x, manuals, lock and key, includes free transformer and battery!		
LSAKIT15S	OmniPro II for Structured Wiring	1,249.99
OmniPro II controller on a Leviton, Open House, Legrand, and UStec structured wiring plate, 16-zone expander, surface-mount console, flush-mount kit, temperature sensor, serial cable, RJ-31x, manuals, includes free transformer and battery!		



LSAKIT15



LSAKIT15S

LSAKIT12E	Omni Ile in Enclosure Kit	864.99
Omni Ile controller in enclosure, surface-mount console, flush-mount kit, temperature sensor, serial cable, RJ-31x, manuals, lock and key, includes free transformer and battery!		
LSAKIT12ES	Omni Ile for Structured Wiring	864.99
Omni Ile controller on a Leviton, Open House, OnQ, and UStec structured wiring plate, surface-mount console, flush-mount kit, temperature sensor, serial cable, RJ-31x, manuals, includes free transformer and battery!		

Text and Email Notification Board

Features

- Send email or SMS texts based on any programming line
- 100 User Programmable Messages
- 8 Customizable Email Addresses
- Adds Network Time Sync to Omni Controllers
- **No service fees or contracts**



LSA20A30-1	Omni Notifier, supports Omni controllers with Ethernet	119.69
------------	--------------------------------------------------------	--------

Zone Expansion



LSA10A06	LSA17A00-1	LSA17A00-9
LSA10A06	16-zone expansion module with accessory kit, maximum of 2 per OmniPro II, Omni IIe, Lumina or Lumina Pro system. For zones 17-32 and zones 33-48	98.75
LSA17A00-1	16-zone/16 output expansion enclosure, lock and key, max 8 per OmniPro II or Lumina Pro system, requires 7Ah battery, 24/40VA transformer	248.69
LSA17A00-9	16-zone/16 output expansion on a Leviton, Open House, Legrand, and UStec structured wiring plate, max 8 per OmniPro II or Lumina Pro, requires 7Ah battery, 24/40VA transformer	307.87
LSA17A00-8	16-zone/16 output expansion board only, max 8 per OmniPro II or Lumina Pro system, requires 7Ah battery, 24/40VA transformer, no mounting hardware included	214.79

Wireless receivers and transmitters are available on page 87

Thermostats - page 95

LSA10A11

Omni Pro II

Hardware	Zones	Outputs
Main Controller *	1 - 16	1 - 8
10A06	16 Zone expander. Up to 2	17 - 48
45A00-1	64 Zone Leviton wireless receiver. Up to 2	49 - 176
42A00-2	64 Zone GE wireless receiver: Up to 2	49 - 176
17A00	16 Zone, 16 Output Expansion enclosure up to 8. Requires battery and transformer.	9 - 136

OMNI IIe

Hardware	Zones	Outputs
Main Controller*	1 - 16	1 - 8
10A06	16 Zone expander - up to 2	17 - 48
45A00-1	64 Zone Leviton wireless receiver	33 - 48
42A00-2	64 Zone GE wireless receiver	33 - 48

OMNI LTe

Hardware	Zones	Outputs
Main Controller*	1 - 16	1 - 8
45A00-1	64 Zone Leviton wireless receiver	17 - 32
42A00-2	64 Zone GE wireless receiver	17 - 32

* Zone 15 is often the outdoor temperature sensor. Output 8 and Zone 16 are used for thermostat communication. Zones 1-4 can be used for 2-wire smokes. Worthington recommends 4-wire smoke detectors starting on Zone 5. 4-wire smokes can be wired to all 48 zones.

Popular Add-on Items

ATWBLOODHOUND	Flush-mount sounder, 90mA, 104dB	8.99
ATWDOBERMANPLUS	Piezo siren with strobe, surface-mount, outdoor, 104dB, 180mA	17.36
LSARC1000WH	Thermostat: conventional single-stage, heat pump and dual fuel systems	149.62
LSARC2000WH	Thermostat: conventional 2-stage, 3-stage heat pump, dual fuel systems, with humidity	197.49
LSA31A00-7	Enhanced extended range indoor/outdoor temperature sensor with bracket	43.89
LSA31A00-8	Enhanced extended range indoor/outdoor temp/humidity sensor with bracket	84.81
LSA36A05-4	RJ-11 to DB-9M connectivity cable. Use with Russound, Lutron, RadioRA 2, Jandy & Centralite.	14.72

2-Way Voice

LSA10A11	2-way voice board: Features a line level output and relay. Includes a 12VDC trigger for speech over a Russound CAV6.6, MCA-C5, MCA-88, or Hi-Fi 2.	98.50
LSA33A00-4	LCD surface-mount console with speaker and microphone, silk screen front, connector kit	143.63

Allows two-way communication with a central station after an alarm, paging and listening from an on-premises or remote phone, annunciation of alarm and zone by voice, and voice messaging

System Consoles



LSA33A00-1 with LSA33A00-3

LSA33A00-1

LSA33A00-1	LCD surface-mount console, silk-screen front	113.03
LSA33A00-23	International version of the LSA33A00-1: uses icons instead of text on the arming buttons	121.73
LSA33A00-4	LCD surface-mount console with speaker and microphone, silk screen front, connector kit	143.63
LSA33A00-3	Flush-mount kit for LCD keypads	19.90

One standard console should be on each installation for setup and backup disarming functionality

4-Wire Smoke Detection (12VDC 4-wire smoke loop)

DSCFSA410B	DSC 4-wire basic smoke	30.80
DSCFSA410BT	DSC 4-wire smoke with heat	30.80
DSCFSA410BST	DSC 4-wire smoke with heat and 85 dB sounder	26.95

4-Wire Smoke Detection Accessories

DSCPRM4W	DSC 4-wire Polarity Reversal Module, forces all 4-wire smokes with sounders to sound	23.62
DSCRM2	DSC 4-wire Smoke Loop Power Supervision Relay	15.29



DSCRM2

DSC Smoke Detectors

Heat

2-Wire Smoke Detection (12VDC 2-wire smoke loop)

DSCFSA210B	2-wire basic photoelectric smoke detector	29.26
------------	-------------------------------------------	-------

Heat Detection (12VDC systems, 4-wire loop)

SYS5601P	Single-Circuit, 135° fixed temp & rate-of-rise	11.88
SYS5602	Single-Circuit, 194° fixed temp & rate-of-rise	11.88
SYS5603	Single-Circuit, 135° Fixed	11.49
SYS5604	Single-Circuit, 194° Fixed	11.88

Glass Break Sensors (12VDC, 4-conductor wire)

DSCAC100	DSC wall-mount glassbreak detector	27.02
DSCAC500	DSC ceiling-mount glassbreak detector	35.51

CO and Gas Detection

MCCM-E1	Macurco carbon monoxide detector with test/hush	56.01
MCGD2A	Macurco combustible gas detector, 12 or 24V, 2 relays	104.38

Water Sensor

GRI2600	Powered (4 wires) water sensor. Uses 12VDC Aux and wires into a zone loop.	15.16
GRI2600T	Powered (4 wires) water sensor with 2 probes. Uses 12VDC Aux and wires into a zone loop.	21.45

Occupancy

SNCM-9-R	12VAC/VDC occupancy sensor, 30 seconds to 20 min., SPDT relay, 13mA draw	82.43
----------	--------------------------------------------------------------------------	-------

Vehicle Detection

- Annunciation Options
- Text or email notification
 - Post a Keypad Message
 - Add a 12VDC Sounder

12VDC Sounder

Out 1 GND



+12VDC GND Z+Z-

Enhance your automation installation with Vehicle Detection.

Hardwired - Cartell page 111
 Wireless - Dakota Alert page 109
 Leviton Wireless - page 89

Magnetic Contacts (10 pack)

GRI20RS-12-*	3/8" stubby, 12" leads, 1/2" gap, white or brown	25.10
GRI20RS-T-*	3/8" stubby, terminals, 1/2" gap, white or brown	28.23
GRI100-12-*	Mini surface contact, terminals, 1/2" gap, white or brown	24.11
GRI7377-W	3/8" stubby with terminals and 1K resistor for use with Omni Controllers, 3/4" gap. 1 per zone loop.	40.84
GRI180RS-12-*	3/4" standard, 12" leads, 5/8" gap,	34.47
GRI4400A	Rail mount garage door, 2 1/2" wide gap, white or brown, each	23.01



GRI20RS-12: This is the standard door and window contact. It has 12" leads for easy installation and 1/2" gap allowance to give some fudge factor.



GRI4400A: In many homes a customer would like to know if the garage door is down when they go to bed. Use the GRI4400A and wire into a zone. Include in the night mode a message if the garage door is left open.



GRI7377-W

Speed up installations by using the GRI7377-W with a built-in EOL resistor. Each contact contains a built-in 1K resistor and screw terminals. Simply attach 2-conductor wire to the contact at the end of the loop and connect the other side of the wire to the Omni Zone terminals. The loop is correctly supervised for a professional installation.

Motion Detectors (12VDC, 4-conductor wire)

NAPP1510	Napco 30' x 30' PIR	12.13
NAPP1680PT	Napco 45' x 45' PIR w/ 65lb pet immunity	19.96
NAPC100STE	Napco 30' x 35' microwave/PIR	20.66
DSCLC100PI6P	DSC economy pet immune PIR	8.78
DSCBV500	DSC 360 degree ceiling mount PIR	27.85
DSCBV600	DSC dual-element pet immune PIR	25.87
OXLX402	Outdoor PIR motion detector, form C relay	78.69



DSCBV500



DSCBV600

Sounders and Strobes

ATWSGST-W	Single-gang flush indoor siren 105dB, 20mA	8.74
ATWBULLDOG	Surface-mount indoor/outdoor siren, 105dB, 110mA	8.99
ATWBLOODHOUND	Single-gang box mount indoor/outdoor siren, 104dB, 180mA	8.99
ATWDOBERMAN	Surface-mount sounder and strobe, 180mA, 105dB, 90mA strobe only	16.61



ATWDOBERMAN



ATWSGST-W



ATWBULLDOG

The maximum sounder output for Omni and Lumina controllers is 1 Amp for interior and exterior outputs combined.

Leviton Supervised Wireless

LSA45A00-1	64 Transmitter wireless receiver, compatible with LSA transmitters only	124.63
LSA46A00-1	3-zone door and window transmitter, mercury tilt switch for garage doors, supports remote sensor	36.66
LSA48A00-1	Wireless 4-button keyfob, each button is learned as a separate zone and can be assigned any function	34.56
LSA63A00-1	Wireless driveway sensor	176.65
LSA56A00-1	Wireless recessed door contact	39.80
LSA47A00-2	Wireless quad pet immune motion detector	89.02
LSA57A00-1	Wireless vanishing contact	55.96
LSA58A00-1	Wireless surface mount mini door contact	39.80
LSA50A00-1	Wireless pendant panic alert	34.56
LSA61A00-1	Wireless glassbreak	110.74
IONMICRA-HA	45A00-1 compatible window sensor	24.98
IONPLUNGER-HA	45A00-1 compatible door sensor	24.98



LSA47A00-2



LSA48A00-1



LSA46A00-1



LSA50A00-1



LSA57A00-1



LSA58A00-1



LSA61A00-1

Supervised Wireless Receiver for Interlogix and Interlogix Compatible Transmitters



GE Compatible Wireless



LSA42A00-2

Using the Interlogix GE wireless receiver will give you the ability to monitor GE wireless devices through your Omni panel.



IONPLUNGER



IONMICRA



LSA42A00-2	64 zone wireless receiver, compatible with GE, Caddx and ITI wireless	258.06
RESRE100	4-button keyfob	14.36
RESRE101	Door/window, also supports external	16.24
RESRE103	Panic, wrist band	18.74
RESRE105	Temperature range sensor	24.98
RESRE106	Tilt sensor, great for garage doors	18.74
RESRE110P	PIR, pet immune to 60lb	49.96
RESRE114	Photoelectric smoke	53.71
RESRE113	Wireless CO detector	59.95
RESRE119	Home disaster transmitter	41.22
RESRE122	NanoMax door/window, supports external input	16.24
RESRE151	Hidden panic	24.98
RESRE152	PINpad keyfob, remote keypad	23.73



Door / Window



Wireless Vehicle Detector



Wireless Smoke



NanoMax Contact

Interlogix Compatible iON Security Transmitters

IONMICRA-G	Interlogix compatible concealed wireless window sensor	24.98
IONPLUNGER-G	Interlogix compatible concealed wireless door sensor	24.98
IONFDB75	3/4" Forstner drill bit for drilling perfect holes	6.24

Z-Wave Lock Integration

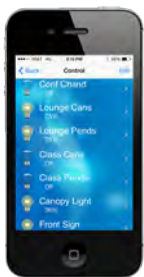

ONLY Leviton Vizia RF + Z-Wave products are 2-way with Omni controllers (unless the Omni is programmed to poll for status updates). See pages 16-17 for Leviton Vizia RF + products and information on beaming compatibility.

- The 2-way capability of Vizia RF + becomes important when using interfaces such as Snap-Link Mobile or touchscreens
- Other Z-Wave devices may have beaming support; however, if the state is changed manually the Omni is not notified.
- Beaming capability in Z-Wave devices is required to enable the automation controller to wake and communicate with locks

See pages 24-26 for Z-Wave locks.



- Use a Leviton VRC0P '3' series Z-Wave serial interface for each installation
- Each installer will need a Leviton VRUSB-1US USB stick to enroll the lock on the Z-Wave network

- Download the Vizia RF + Installer Software: www.leviton.com/rfinstaller
- 'Beaming Compatible' Z-Wave devices are required for extending communication to Z-Wave Locks

LEVVRUSB-1US	USB adapter for RF+ Installer software	69.92
LEVVR0P-1LW	Vizia RF + Z-Wave serial interface module	89.15

Purchase \$500 of Vizia RF + and receive a FREE VRC0P serial module

ZigBee HA Integration for Omni Controllers

Kwikset



BD99100-01*	ZigBee HA Standard Motorized Deadbolt, * 5-Polished Brass, 6-Satin Nickel, 7-Venetian Bronze	137.39
BD99120-00*	ZigBee HA Motorized Lever Lock, * 7-Polished Brass, 8-Satin Nickel, 9-Venetian Bronze	168.62

ZigBee Interface Module



The ZIM is a wireless coordinator for ZigBee products; plugs into a serial port on an Omni or Lumina controller. Allows control of other ZigBee products such as lighting control, locks, shades, and more!

See page 97 for additional ZigBee products.

LSA81A00-3WHZB	Serial ZigBee Interface Module (ZIM)	193.90
----------------	--------------------------------------	--------

- The ZigBee Interface Module is designed to work with ZigBee HA Profile products
- Products on this page feature ZigBee HA communication
- ZigBee HA Profile products work together to form a communication mesh



YALL220*	YALD216*	Yale	YALD226*	YALD256*
YALD226ZBHA+	Backlit capacitive keypad Zigbee HA lock with motorized deadbolt			206.08
YALD256ZBHA+	Backlit touchscreen Zigbee HA lock with motorized deadbolt and no cylinder			206.08
YALD216ZBHA+	Backlit push button Zigbee HA lock with motorized deadbolt			168.62
YALL220ZBHA+	Backlit capacitive touchscreen lever lock with Zigbee HA			206.08
YALL210ZBHA+	Backlit push button keypad lever lock with Zigbee HA			187.35

(+605-Bright Brass, 0BP-Oil Rubbed Bronze, or 619-Satin Nickel)

Jasco Zigbee Lighting

JAS45856GE	Jasco 600W In-wall Dimmer - Zigbee	43.44
JAS45857GE	Jasco 15A In-wall Switch - Zigbee	46.60
JAS45852GE	Jasco Plug-in lamp dimmer module	41.89
JAS45853GE	Jasco Plug-in appliance module	39.94

See Jasco's devices on page **

Jasco Zigbee lighting will work directly with the Amazon Echo Plus. For more information, give us a call.



JAS45856GE

JAS45852GE

Access Control Power Supplies



LSA83A00-1

- Output: up to 5 amps @ 12VDC
- Connect up to 2 12VDC 8Ah batteries for backup
- Can power up to 8 readers with door strikes

LSA83A00-1	12VDC 5A power supply in an enclosure	286.76
LSA83A00-2	12VDC 5A power supply on mounting plate	286.76
UB1250	Battery, rechargeable, 12V, 5Ah	10.61

LSA54A00-1

- Brushed stainless design for outdoor applications
- Piezoelectric buttons can be used with a bare finger or gloves
- Connects to an Omni controller via the serial port
- Vandal resistant
- Piezoelectric buttons work simply by tapping the surface, and do not require an actual physical movement

LSA54A00-1	Outdoor Brushed Stainless Serial Keypad	273.20
------------	-----------------------------------------	--------



Access Control Reader and Door Strike

- 26-bit proximity card reader
- Connects to an Omni controller serial port
- Durable and scratch-resistant polycarbonate housing
- Full epoxy potting ensures full-weather resistance
- 2 color LEDs and piezo sounder ensures an intuitive interface
- Doorstrikes can be connected directly to the reader
- Seamless integration in 3.0 firmware and software



LSA75A00-2



LSA78A00-2

LSA79A00-1

LSA78A00-1

LSA75A00-2	Access Control Card Reader: Requires 3.0+ firmware and power supply	186.20
LSA78A00-1	Pack of 10 access control cards	38.40
LSA78A00-2	Pack of 10 key tags	50.47
LSA79A00-1	Fail secure 12VDC door strike	48.60
ACSSREX-100	Request-to-exit motion, form C	85.53

Lighting Control Dimmers and Switches (Requires Neutral)



LSA35A00-1	600W incandescent UPB dimmer with tri-colored LEDs, white	59.77
LSA35A00-1CFL	600W incandescent, LED, and compact fluorescent UPB dimmer. Tri-colored LEDs, white.	59.57
LSA35A00-3	600W incandescent only UPB non-dim switch. Tri-colored LEDs, white	59.77
LSA40A00-1	15A UPB relay switch. Any load type. Tri-colored LEDs, white	76.03
LSA71A00-1	UPB 30A 120/240V load control module	266.09
LSA37A00-1	Auxiliary switch for 35A00-1, 40A00-1, and 55A00-1 3-way applications, white	24.85

See below for color change kits.

Lighting Control High Wattage Dimmers (Requires Neutral)

LSA55A00-3*	2400W inductive UPB dimmer with tri-colored LEDs. (*WH-White, IV-Ivory)	459.65
-------------	-------------------------------------------------------------------------	--------

Lighting Control Keypads (Requires Neutral)

LSA38A00-1	6-button UPB room controller with IR (scene switch), White	108.72
LSAHLCK6-00*	6-button UPB room controller, white or light almond	38.94
LSA38A14-1	IR Handheld remote control for the 6-button room controller - Free on request with purchase of LSA38A00-1 (while supplies last)	38.94
LSA38A00-2	8-button UPB house controller (house status switch), White	129.14
LSA38A16-*	Tabletop cradle with UPB room controller (WH-White, BL-Black)	148.12
LSA38A15-*	Tabletop cradle for UPB room controller (WH-White, BL-Black)	34.40



Custom Engraving

LSA38A06-2 Custom engraving coupon for HLC controllers

FREE*

For Engraving details please scan the QR code below.



Lighting Control Plug-In Devices

LSA59A00-1	300W UPB lamp module	60.32
LSA60A00-1	15A appliance module	76.03

Lighting Color Change Kits

LSA35A14-*	Change kit for 35A00 dimmer, 40A00 switch, 37A00 auxiliary	4.09
LSA38A04-*	6-button room controller	3.23
LSA38A05-*	8-button house controller	3.23

*WH-White, IV-Ivory, AL-Almond, BL-Black, BR-Brown, GR-Gray, or LTA-Lt. Almond

Home Lighting Control UPB Accessories

LSA36A00-1	UPB powerline interface module with cable for Omni family of controllers	62.51
LSA36A05-2	Cable for serial PC to LSA36A00-1 (PIM) connection for UpStart software	21.22
LSA39A00-1	UPB phase coupler (different than X10 coupler) with LED indicator	58.60
LSA39A00-3	3-phase UPB repeater	397.90
LSA39A00-2	Split single phase UPB repeater	278.06

Key Features of Home Lighting Control

- Home Lighting Control (HLC) uses proven UPB technology with over a 10-year track record for reliability and ease of installation
- "Programming on the 8's" technology makes it easy to list rooms and devices on touchscreens and mobile interfaces. No additional programming required.
- Complete 2-way scene-based lighting system with room controllers, whole-house status monitoring and individual load control
- 3-phase repeater is available for small commercial or residential MDU applications
- Gen III dimmers provide automatic time out, ability to switch dim/non-dim in the field, better CFL/LED compatibility, and better tolerance for power frequency variations



Home Lighting Control on OmniTouch 7 (above)
Home Lighting Control on an iPhone (left)

LED lighting loads are more popular than ever, but dimming them can be a challenge. We have tested many different LED dimmers with many different LED bulbs. The Leviton 35A00-1CFL is one of the best performers we have seen. It's also one of the most economical. It's one more reason to make HLC your go-to lighting on Omni systems. To check if your LED bulb is compatible, scan the QR code here:



OmniTouch 7 Touchscreen

7" Touchscreen for
Leviton Omni Controllers

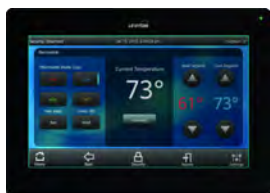

Temperature Control



Home Screen



Cameras



Lighting



Audio

The capacitive touch glass-front touchscreen from Leviton features a 7" diagonal viewing area for control of your security, energy, and entertainment settings. No set up required other than entering the automation controller's IP address and adjusting the port and encryption keys. Designed for the OmniPro II, Omni Ile, Omni LTe, and Lumina RF Gateway automation systems.

Specifications:

- Large 7" diagonal viewing area with minimal black or white surround
- Glass-front high resolution capacitive touchscreen
- Modern, easy-to-use interface with swipe capability
- PoE connection provides all power and communication
- Firmware updates via Ethernet
- Digital amplifier and speaker
- Intercom capabilities with use of Grandstream SIP server
- An installation which features the OmniTouch 7 Touchscreen must contain a standard LCD console (LSA33A00-1) for UL Listing

LSA99A00-*	Ethernet-enabled 7" PoE In-Wall Touchscreen (*1 - White, 2 - Black)	397.98
LSA99A10-*	Trim kit for replacing a 5.7, 5.7e or 3.9 touchscreen	24.92
LSA90A00-1	PoE Injector: Use with the OmniTouch 7	49.01
LSAPOENS-8PT	8-port (8 PoE) 10/100 Mbps Ethernet Switch	179.84
LEVPOEMP-KIT	PoE Switch Mounting Kit for Structured Wiring Systems	119.89

Intercom and IP Doorstation

The latest firmware for OmniTouch 7 includes an IP intercom icon. It uses the SIP communication standard, which offers great interoperability. Use the Grandstream UCM620x (page 180) to enable the features on OmniTouch 7 screens including intercom between OmniTouch 7 screens and Grandstream IP phones. Add the Leviton IP door station to have full video and 2-way voice with your front door.

See page 190-191 for more GrandStream IP phones that work with the Leviton Door Station



PoE (Power over Ethernet)

PoE is an efficient way to power supported network devices like the OmniTouch 7 and IP cameras. With PoE, a single Cat 5e/6 cable carries Ethernet data and power from a PoE switch to a device. When more than one PoE device is in use on a job, it is recommended to use a PoE switch rather than injectors to keep the installation clean and more energy efficient.



LUXXMS-2624P



LUXXFS-1084P



LUXXMS-1010P



GRAUCM6202

LUXXFS-1084P	8-port (4 PoE) 10/100 Mbps Compact Ethernet Switch, unmanaged, full 15.4W per port	70.43
LUXXMS-1010P	10-port (8 PoE) 10/100/1000 Mbps Ethernet Switch, 1U rack, full 15.4W per port	224.82
LUXXMS-2624P	26-port (24 PoE) 10/100/1000 Mbps Ethernet Switch, 1U rack, managed, 320W PoE budget	646.98

What you need for an intercom solution with the OmniTouch 7:

1. Newest firmware on your OmniTouch 7
2. Grandstream PBX SIP server
3. PoE power source
4. The new Leviton IP Doorstation!

LSAINDS1-S	Leviton IP Door station. SIP server and POE required.	498.60
LSAINDBB	Back box for LSAINDS1-S	21.97
GRAUCM6202	IP SIP Server and PBX, up to 150 extensions, 2 analog CO lines, 30 concurrent calls	210.47

Bitwise by Leviton

BitWise



- Controls A/V components
- Pre-designed templates make it simple to create stunning user interfaces
- Free iOS and Android apps
- Optional handheld remote
- Integration with Omni controllers
- Great for: Residential and commercial (conference rooms, classrooms, sports bars) and more!



Add-On Hardware and Accessories



BITWRRR

BITBWRMT

BITBWIRL	USB IR learner. Great labor saving tool. Learn IR codes from existing remote controls.	149.88
BITBWRMT	RF hard-button remote control. Requires BITWRRR wireless receiver.	95.91
BITWRRR	RF receiver for hard-button remote	59.94
BITBWIRI	IR to RS232 receiver module	89.33
BITBWEAR	Rack ears for BC2 controller	38.67
BITEN928	IR emitter single head, each	9.32

Controllers



Leviton's network-enabled controllers are the heart of every BitWise installation. These devices provide the intelligence and connectivity to control virtually any TV, Blu-ray, AV receiver, projector, and other gear. Each BitWise system is comprised of one or more controllers, which allow the other systems in your home to interact with one another. Your system can scale from a single room to an entire home or building. BitWise can integrate your favorite Leviton Omni controller for control of security, lighting, HVAC, shades, and more.

BITWBBC1	BC1 Controller, 8 IR ports, 4 GPIO, 4 relays, 1 IR input	928.66
BITWBBC2	BC2 Controller, 4 IR ports, 2 RS-232, 2 GPIO, 2 relays	592.93
BITWBBC4	BC4 Controller, 4 IR ports, 1 RS-232, 1 GPIO	329.14

Emitters not included and must be purchased separately.

Custom OmniTouch 7 Touchscreen



Home Theater



Floorplan View



Home Screen

BITEVOLUTION For OmniTouch 7 and Bitwise app for iOS and Android 199.00

This customization can be deployed to the OmniTouch 7, iOS, and Android devices. Unlimited uses and price includes 2 hours of support.

Custom Programming is available from Worthington for BitWise controllers and more. Give us a call today!

If you have a customer that wants the next level of automation and control, look no further than the Worthington template package! The new release of BitWise Project Editor software allows customization of the OmniTouch 7! Our graphics expert has created the look and feel of a standard touchscreen but added great features like floorplan views, weather forecasts, home theater control, built in help pages, and more!

Hi-Fi 2 Distributed Audio

Hi-Fi 2 Systems

LSA95A00-1	8-Source, 8-Zone Kit in enclosure, 4 RIMs (4 sources can be plugged in directly), 8 VSCs, IR Remote	1,893.68
LSA95A00-2	8-Source, 8-Zone Kit for structured wiring, 4 RIMs (4 sources can be plugged in directly), 8 VSCs, IR Remote	1,893.68
LSA95A01-1	8-Source, 8-Zone Amplifier Only	1,395.61

Hi-Fi 2 Expansion Systems Zones 9-16

LSA95A12-1	8-Source, 8-Zone Expansion Kit in enclosure, 8 VSCs. Must be mounted within 6" of the main Hi-Fi 2 system, interconnect cable.	1,794.12
LSA95A12-2	8-Source, 8-Zone Expansion Kit for structured wiring, 8 VSCs. Must be mounted within 6" of the main Hi-Fi 2 system, interconnect cable.	1,794.12
LSA95A18-1	8-Source, 8-Zone Expansion Amplifier only, expansion cable sold separately	1,345.62

Hi-Fi 2 Volume and Source Selection (VSC) Keypad

LSA95A03-1	Hi-Fi 2 Keypad with OLED display and IR receiver	128.87
LSA95A11-*	Hi-Fi 2 Keypad (VSC) color change kit	2.74

*WH-White, IV-Ivory, AL-Almond, BL-Black, LTA-Lt. Almond

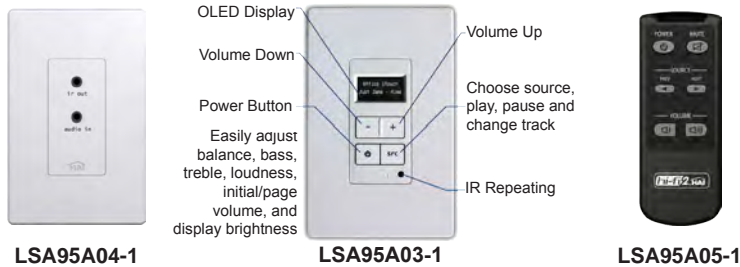

LSA95A00-2



LSA95A00-1

Hi-Fi 2 Features

- 8-Source / 8-Zone with 50 Watts per zone digital amplification
- Expandable to 8-Source / 16-Zone with the LSA95A12
- Keypads feature a crisp OLED display
- Simple 4-Button interface for power, volume, source selection and audio settings
- Input 8 can be used as a system page
- Built-in serial or Ethernet communication
- Built-in power supply
- Compatible with OmniPro II, Omni IIe, Omni LTe, Lumina Pro and Lumina controllers
- Compatible with OmniTouch 7 touchscreens



Flexible Source Wiring

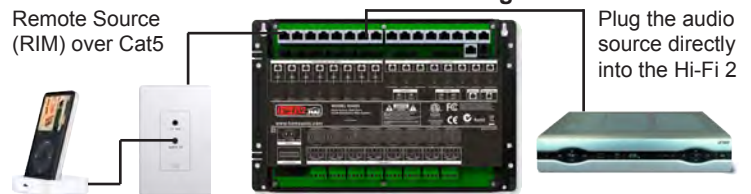

Hi-Fi 2 Remote Input Module (RIM)

Hi-Fi 2 allows the installer to locate Remote Input Modules (RIMs) near sources to make audio available in each room with a Volume Source Control (VSC) and speakers. The amplifiers mount on a closet wall or in a structured wiring cabinet for a clean installation. Hi-Fi supports up to eight zones and six sources. It fully integrates with Omni controllers, touchscreens, and software packages.

LSA95A04-1	Hi-Fi 2 Remote Input Module (RIM)	48.87
LSA95A10-*	Hi-Fi 2 Remote Input Module color change kit	2.74

*WH-White, IV-Ivory, AL-Almond, BL-Black, LTA - Lt. Almond
See next page for the Bluetooth Remote Input Module (RIM)

Hi-Fi 2 Accessories

LSA95A09-1	Hi-Fi 2 vented enclosure	81.55
LSA95A05-1	IR remote control for the Hi-Fi 2	23.69
LSA95A16-1	Hi-Fi 2 expansion cable	14.96

Hi-Fi 2 Source Cables

LSA95A14-1	Retractable male 3.5mm to male 3.5mm cable, for use with Hi-Fi 2 RIM	7.54
LSA95A13-1	Retractable male 3.5mm to male RCA cable, for use with Hi-Fi 2 RIM	7.54

Hi-Fi 2 4-Source 4-Zone Distributed Audio



LSA95A00-3	Hi-Fi 2 4x4 System: Includes the Hi-Fi 4x4, 2 Remote Input Modules (RIM), 4 OLED Volume-Source Controls (VSC), remote control & power supply; Mount directly into a Leviton Structured Media Center wiring enclosure.	946.75
LSA95A02-3	Hi-Fi 2 4x4 Controller Only	697.21

Hi-Fi 2 4x4 Features

- 4-Source / 4-Zone with 40 Watts per zone digital amplification
- Keypads feature a crisp OLED display
- Simple 4-Button interface for power, volume, source selection and audio settings
- Built-in serial or Ethernet communication
- Compatible with OmniPro II, Omni IIe, Omni LTe, Lumina Pro and Lumina controllers
- Compatible with OmniTouch 7 touchscreens



CasaTunes Internet Music Streamers

CasaTunes
music by the roomful

CasaTunes focuses on the design of multi-room music servers. CasaTunes is the ideal solution for 3 rooms or as many as 24. This is what customers will typically interact with every time they want to listen to their music. It has to be simple, reliable and, well, fun!

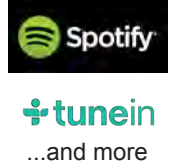

Multi-Source Streamers



CASCT-2

CASCT-3S

The CasaTunes Streamers supply 1 to 8 sources of streaming music to your existing system. Each stream can be your iTunes or Windows Media songs, streams from internet music services, audio from uPnP/DLNA media servers, even music sent to CasaTunes via AirPlay from your iPad or iPhone.

CASCT-1	One-stream controller	389.00
CASCT-2	Two-stream controller	520.00
CASCT-3S	Three-stream controller	750.00
CASCT-4S	Four-stream controller	1,050.00
CASCT-8S	Eight-stream controller	1,395.00

OmniTouch 7 Integration

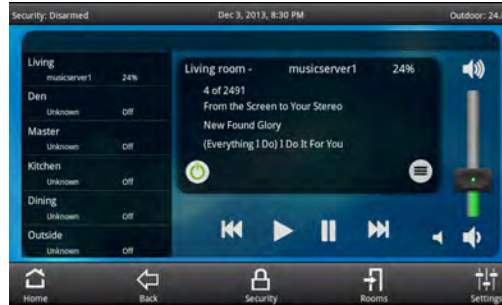

CasaTunes provides meta-data on the OLED VSC keypads and OmniTouch 7. Set up takes just minutes and configures the Leviton Hi-Fi 2 for you!



App Control - More than just song selection!



Works with these great systems and more!



CasaTunes is a great reason to contact any customer that might have an aging whole-home music system. The CasaTunes streamers allow a simple upgrade path to take a dated system and add modern app and streaming control! New or legacy whole home audio systems like the Russound CAV6.6 are perfect for integration with any of the CasaTunes streamers. Integration is via serial or network depending on the system.

Bluetooth Remote Input Module (RIM)



The Bluetooth Remote Input Module (RIM) allows Bluetooth-enabled devices to connect and act as music servers for the Hi-Fi 2 distributed audio system. Play music from Pandora, Spotify, Rhapsody, iTunes, or any other service compatible with Bluetooth enabled portable audio devices.

Available only in white.



LSA95A04-2	Bluetooth Remote Input Module (RIM) for Hi-Fi 2	178.52
LSA95A15-*	Color change for the Bluetooth RIM	11.45

*WH-White, IV-Ivory, AL-Almond, BL-Black, LTA-Lt. Almond

Hi-Fi 2 App

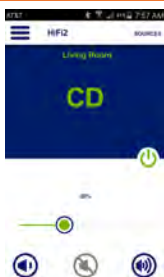

The Leviton Hi-Fi 2 whole home audio controllers can use a standalone app; an Omni controller is not needed. The app, for Android or iOS allows a user to control a Hi-Fi 2 directly over Wi-Fi and IP. Configuration is easy, just click "Discover" and the app does the rest.

We carry all CasaTunes products. Give us a call for additional parts.

2-Way Voice Integration with Hi-Fi 2 Page Input

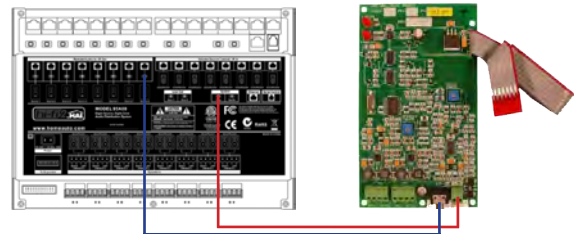

Looking to have the Omni speak throughout the house or looking to use any phone in the house as an "All Page?" It is simple. Just add an LSA10A11 two-way voice board and connect it to the Hi-Fi 2. Start with an 1/8" mono jack and attach the two leads to the trigger output of the LSA10A11 board. If you need a cable, an IR emitter works great, just cut off the flasher. Next, use a stereo 1/8" connection between the audio out on the LSA10A11 and input 8 on the Hi-Fi 2 (mono does not work). Use the Hi-Fi 2 software to set up page zones and volume. Any time the LSA10A11 is active (LED is on) the page feature will activate.

LSA10A11	2-way Voice Board - Features a line level output and relay. Includes a 12VDC trigger for speech over a Russound CAV6.6, MCA-C5, MCA-88, or Hi-Fi 2.	98.50
----------	-----------------------------------------------------------------------------------------------------------------------------------------------------	-------



The HomeSeer Hometroller Zee is a home gateway that has a driver for Omni panels and also supports Amazon Alexa. This setup will allow you to use Alexa to control anything on an Omni panel! All you will need is the below controller and an Alexa enabled interface (echo/echo dot, etc.).

Upon purchase of the Homeseer Hometroller Zee S2, you will receive a video walkthrough. In the meantime, if you want to check out our overview video, check out our YouTube channel.

www.youtube.com/worthingtondist



HSHT-ZEE Homeseer Hometroller Zee S2 - **Paid Plug-in required for Omni Driver 154.84



Things we can do with Alexa:

- “Alexa, Tell Homeseer to arm my Omni Security System to away.”
- “Alexa, Tell Homeseer to turn on the kitchen lights.”
- “Alexa, Tell Homeseer to set back the thermostat to 65.”
- “Alexa, Tell Homeseer to lock all of the doors.”



Water & Gas Control

Sensors and Accessories

GRI2600	Hardwired 12VDC water sensor	15.16
GRIT8000-G	Hardwired freeze sensor, 32-degree switch, NC	32.30
WIWB200	WaterBug 200, includes 1 sensor, expand to 6	55.71
WIW-S-U	Additional sensors for the WIWB200	19.48
RESRE119	Water and low temp sensor for GE wireless (LSA42A00-2 compatible)	41.22
ELK912	12V Relay for valve status monitoring	6.16

Omni Compatible Motorized Water Valves

GRNASV050	1/2" Motorized water valve, handle, power supply	337.40
GRNASV075	3/4" Motorized water valve, handle, power supply	375.92
GRNASV100	1" Motorized water valve, handle, power supply	318.15
GRNASV150	1 1/2" Motorized water valve, handle, power sup.	656.56
GRNASV200	2" Motorized water valve, handle, power supply	843.65
GRNASV075G	3/4" Motorized gas valve, handle, power supply	582.27
GRNASV100G	1" Motorized gas valve, handle, power supply	637.30

The average flood insurance claim is over \$10,000. Give your home or business 24/7 protection from interior flooding with an automated water valve. Add it to your home control system and the water supply can be controlled remotely giving you total control from home or away.

- Integrates with Omni and other Automation Controls
- Fast Action Opening and Closing
- Possible Insurance Discounts
- Stainless Steel construction
- NSF mark ensuring the valve is safe for use with drinking water



For Z-Wave controlled water valves see FortrezZ on page 29.

- Vacation homes need constant monitoring for low temperature, water damage, security and fire protection
- The Omni is perfect for monitoring and automating vacation homes
- Monitor for water leaks, flooding or low temperature conditions
- Install a temperature sensor in a closet. Program the valve to close if the temperature drops to 40°.
- Provide home control via the Snap-Link App

Wiring Diagram

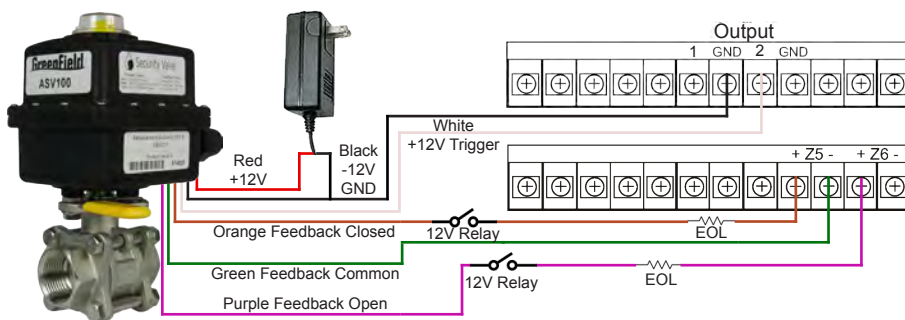

Valve	Function	Connected to
Red	Power (+) Positive	+12 VDC Supply
Black	Power (-) Negative	-12 VDC Supply & GND
White	+12 VDC trigger	+12 Output
Orange	Feedback closed	Zone +: Relay, EOL in series
Green	Feedback common	Zone -
Purple	Feedback open	Zone +: Relay, EOL in series

Note: Open/Close condition; the zone becomes 'Secure'

Omnistat2 - Hardwired

LSARC1000WH	Thermostat: conventional single stage, heat pump and dual fuel systems. White.	149.62
LSARC2000WH	Thermostat: conventional 2 stage, 3 stage heat pump, dual fuel systems, humidity and dehumidification. White.	197.49

Choosing the Correct Thermostat	RC2000	RC1000
Humidifier and dehumidifier control	•	
Humidity sensing and display	•	
Master thermostat for damper control applications	•	
Supports up to 2-stage conventional & 2-stage heat pump with 3rd-stage auxiliary heat	•	
Supports Temperature Display Control	•	
Supports dual fuel systems	•	•
Automatic heat/cool changeover	•	•
Filter reminder for peak efficiency	•	•
Seven day schedule with copy function	•	•
Fan cycle mode periodically circulates air	•	•
Graphical display of HVAC usage by week	•	•
Indoor sensor averaging with remote sensor	•	•
Motion activated multi-color adjustable backlight	•	•
Temperature readings in Fahrenheit or Celsius	•	•
Learns a home's heating and cooling patterns	•	•
Communicates with Omni systems	•	•
Settings for Home, Night, Away, and Vacation	•	•

Omni Integration

- Wires directly to the Omni or Lumina controller
- Only 3 conductors needed for communication
- Complete 2-way communication
- Automated setbacks (choose your approach)
 - Built-in thermostat set point time schedule
 - Automatically change to set points stored in the thermostat based on arming level
- Use controller logic to control set points
- Manual override with hold capability



LSARC1000-WH

Easy To Use

- Simplified and advanced menu structures
- Automatic changeover between heat & cool
- Fan cycling for maximum comfort
- All models meet the EPA's ENERGY STAR guidelines for energy efficiency
- Outdoor temperature display
- Time display synced with the controller
- Select from over 100 different backlight colors



A Large Display Makes Programming Easy

Omni and Lumina Temperature Sensors

LSA31A00-7	Enhanced Extended Range Indoor/Outdoor Temperature Sensor with mounting bracket	43.89
LSA31A00-8	Enhanced Extended Range Indoor/Outdoor Temperature and Humidity Sensor w/ bracket	84.81
LSA14A00-8	Water Temperature Sensor module & probe	78.46



LSA31A00-7

Outdoor temperature is displayed on thermostats.

Omnistat2 Temperature Display Controller

The TDC is a simple-to-use interface that can be added to RC2000 series thermostats (hard-wired and ZigBee). Start with the kit, which includes the interface module that connects the TDC to the thermostat. Use the LEV47603-110 Cat 5e wiring module to add up to 3 more TDCs for a total of 4 per RC thermostat.



A great solution to get a "regular thermostat" off the wall!

LSA95A03-1TWH	TDC only, add up to 3 for 4 TDCs per stat	118.70
LEV47603-110	Bridged Cat 5e module, use to add TDCs	22.81

Color Change Kits Available: Black (95A19-BL), Light Almond (95A19-LTA), White (95A19-WH)

LSA95A19-*	TDC color change kit	118.70
------------	----------------------	--------

*=BL - Black, LTA - Light Almond, WH - White

Omnistat2 - ZigBee Wireless

LSARC1000WHZB	ZigBee HA Thermostat: conventional single stage, heat pump and dual fuel systems	208.46
LSARC2000WHZB	ZigBee HA Thermostat: conventional 2 stage, 3 stage heat pump, dual fuel systems, humidity and dehumidification	248.36
LSA81A00-3WHZB	ZigBee HA serial interface	193.90



ZigBee

Omnistat2 ZigBee thermostats provide precise digital control over the heating, ventilation, and air conditioning (HVAC) systems. The Omnistat thermostats communicate with control systems via mesh networking technology and has a high-power radio with a range of over 200 feet. These thermostats can be utilized when running a new communication wire is challenging. Check out page 97 for other great Leviton ZigBee products.

For the full line of Leviton Zigbee devices, please refer to page 99.

Thermostat Accessories

LSA29A00-1	Relay Isolation Module: use with first generation Omnistats or Omnistat2's with non-standard voltages	116.11
LSA29A00-2	Relay Isolation Module for use with water furnaces	107.80
LSA30A00-2	Thermostat Power Stealing Boost Module, increases available current to prevent thermostats from resetting	39.89
LSA65A18-1	Backplate Trim ring for Omnistat2 retrofits	25.27
LSA23A00-1	Surface Indoor Temperature Sensor for thermostats, allows remote mounting of an Omnistat or Omnistat2	34.14
LSA23A00-2	Flush Indoor Temperature Sensor for thermostats, allows remote mounting of an Omnistat or Omnistat2	38.40



LSA23A00-2



LSA23A00-1



Yale Works for YouSM

In Residential and Small Business



B1L / T1L Locks

Assure Lock Family

nexTouch

The features you need, the quality you expect, and a price that will surprise you from the leading smart lock brand.



zigbee

nexTouchSM Wireless

Need a connected solution for securing a small business?

- Integrates seamlessly with existing alarm systems
- Easy to deploy
- Create new RMR opportunities



Nest x Yale Lock

The connected lock for a more secure Nest home.

- Remote control from the Nest app
- Know who's coming in and out of your home
- Create up to 20 unique passcodes
- Tamper-proof key free, connected deadbolt lock



zigbee

Works with Apple HomeKit

Assure LockSM SL

Slim key free touchscreen deadbolt.

- Backlit keypad wakes with a touch
- One-touch locking and auto relock options
- Available with Z-Wave Plus, Zigbee or HomeKit capabilities

Worthington Sales, Customer Service, Tech Support, and Training
24 Hour Order Line and Tech Support 800-282-8864

Lumina Gateway - Light Commercial Energy Management

- Apps and cloud services for mobile devices
- 200ft wireless range
- Supports Android App, iOS App and Touchscreen
- Control and Scheduling Capabilities
- Leviton Lighting and Load Controllers on this Page
- Leviton Wireless thermostats
- Leviton Binary Sensors (Door/Window, Motion, Occupancy)



The Lumina RF Gateway is a quick and cost-effective solution that performs similarly to an Omni, but without the wired inputs and outputs. With built-in wireless communication, the Lumina RF Gateway is ready to take on applications where lighting, HVAC, and high current loads need to be automated.

The Lumina RF Gateway has options like iOS and Android apps and a touchscreen. Robust Lumina RF wireless communications make it just as suitable for light commercial applications. Installing the Lumina RF Gateway in commercial spaces like restaurants, offices, and retail shops can provide business operators with significant energy savings. Pair the Lumina RF Gateway with lighting controls and thermostats and use basic automation routines to turn off lights and set back thermostats whenever possible.

LSA74A00-1	Lumina RF Gateway with on-board ZigBee	249.80
------------	----------------------------------------	--------

ZigBee HA Load Control Modules for Lumina Gateway and Omni



LSAZSS10-G0Z

LSAZSS10-G0Z	10A, 120/277 VAC Switch, ZigBee	69.94
LSA73A00-3ZB	30A ZigBee HA RF control module	179.54
LEVDL1KD-1BZ	Lumina RF Full Phase 1000W Dimmer	49.95
LEVDL6HD-1BZ	Lumina RF Full Phase 600W Dimmer	44.95
LEVDL15S-1BZ	Lumina RF 15A Switch	44.95
LEVDL15A-1BW	Lumina RF 15A Plug-in Switch	34.96
LEVDL3HL-1BW	Lumina RF 300W Plug-in Dimmer	34.96

ZigBee HA Thermostats for Lumina Gateway and Omni

LSARC1000WHZB	ZigBee Thermostat: conventional single stage, heat pump and dual fuel systems	208.46
LSARC2000WHZB	ZigBee Thermostat: conventional 2 stage, 3 stage heat pump, dual fuel systems, humidity and dehumidification	248.36



Wireless Sensors for Lumina Gateway

LSALURDW-W	Lumina RF Door/Window Sensor	37.35
LSALURMD-W	Lumina RF Motion Sensor	51.96
LEVZSC04-INW	Lumina RF Occupancy Sensor, 450 sq ft	79.94
LSAZSC15-IAW	Lumina RF Occupancy Sensor, 1500 sq ft	79.94



LSALURDW-W



LSALURMD-W



LSAZSC04-IAW
LSAZSC15-IAW

Somfy Window Treatment Motor Controls for Lumina Gateway and Omni

somfy Schedule window treatment positions to save energy



SOM1870221	Add ZigBee HA Profile to a Glydea drupe motor	180.00
SOM1870220	Add ZigBee HA Profile to an RS-485 or ILT motor	355.96

Omnistat3 Hospitality Thermostat

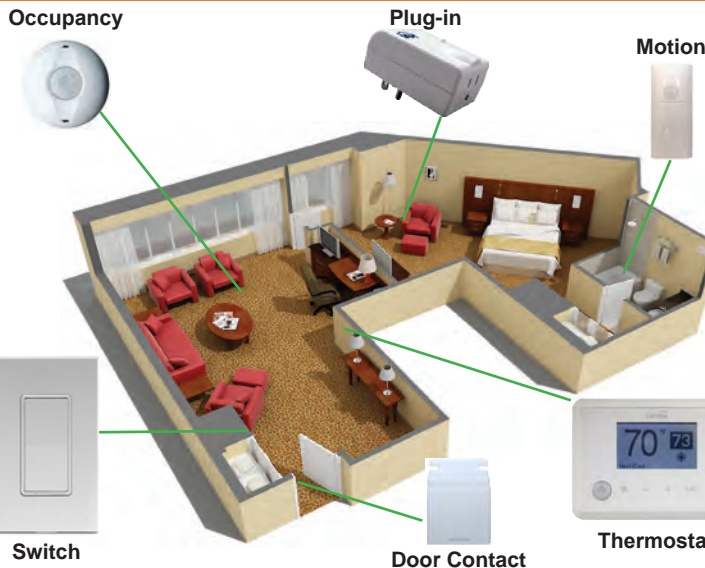

Works with the following Lumina RF products:

- Door Window Sensor
- Motion Sensor
- Occupancy sensors
- Line Voltage Load Control Modules
- Plug-in Load Control Module
- Switches



Leviton guest room solutions offer reliable, cost-effective control of HVAC, lighting, and electrical loads to create scalable alternatives to traditional hospitality guest room controls. Upgrade guest rooms to enhance guest experiences, improve the working environment for staff, increase energy savings and meet energy code compliance requirements

LSARC500-2EW	Hospitality Thermostat: Conventional 2 stage, 3 stage heat pump, 2-pipe, and 4-pipe systems.	159.87
--------------	----------------------------------------------------------------------------------------------	--------

Omni-Bus-Lighting



Features:

- The Omni-Bus Lighting Control Network is a hardwired and wireless lighting solution
- Omni-Bus products work as stand-alone or with an Omni Controller
- An Omni home control system has the ability to change your light settings by the time of day, a set schedule, by the triggering of events (including motion), via a telephone call, touchscreen, smart phone, or by a computer connected to the Internet
- Utilizes the DIN rail standard for mounting load control modules
- Supports CFL, LED, electronic low-voltage, halogen, and incandescent loads
- Dimmer or switch modules feed power to the load
- Keypad buttons are associated with load modules for individual, group control or scene control
- Low voltage relay interface (irrigation valves, gates, etc.)

Overview:

- Hardwired lighting system
- Modular/Centralized installation
- Commercial or large residential applications
- Can interface with Omni and Lumina Gateway
- 120V/60Hz or 220V/50Hz
- Dimming and Switching Modules
- DIN Rail Mounted

BitWise

- Pre-designed templates make it simple to create stunning user interfaces
- Free iOS and Android apps
- Optional handheld remote
- Integration with Omni controllers
- Great for: Residential and commercial: conference rooms, classrooms, sports bars and more!



Omni-Bus Core Modules (Required on each system)

The first step in the Omni bus process is to figure out how many modules you will have in your system. What follows are the required devices to get your system going.

LSA117A00-1	Omni-Bus Interface Translator - Serial connection to Omni controllers, RF receiver for RF keypads, Ethernet port - DIN Rail Mount	498.05
LSA123A00-1	Omni-Bus Power Supply Module - 24VDC 2.5A - DIN Rail Mount	128.67
LSA124A00-1	Omni-Bus Power Supply Interface - 2A supervision of power to the Omni-Bus network - DIN Rail Mount	98.91
LSA120A00-1	Omni-Bus 8-way Splitter, connects 8 Cat5 drops to a single Cat5 port - DIN Rail Mount	49.07
LSA122A00-1	Omni-Bus Termination Plug, one per system	9.87
LSA121A00-1	Omni-Bus Jumper Plugs, use on any unused Omni-Bus ports. Sold in packs of 10.	25.14
LSA116A00-1	USB Programming Interface + software license	245.62



LSA117A00-1



LSA123A00-1



LSA124A00-1



LSA120A00-1



LSA116A00-1



LSA122A00-1



LSA121A00-1

Omni-Bus Input and Output Modules

LSA110A00-2	Omni-Bus Dimming Module, 600W leading edge dimming for incandescent, halogen, electronic or magnetic loads or, 300W trailing edge dimming for CFL/ LED - DIN Rail Mount	168.29
LSA112A00-1	Omni-Bus Relay Module, 4 relays, 2A - DIN Rail Mount	99.11
LSA111A00-1	Omni-Bus Switch - 1500W @ 110VAC -DIN Rail Mount	98.50
LSA110A00-1	220V 400W Dimmer for international markets	108.62
LSA114A00-1	Omni-Bus 6-Channel Universal Switch Interface, 6 inputs and 6 two-lead bi-color or single-color LED outputs - DIN Rail Mount - Add 114A01-1	48.48
LSA114A01-1	Cable assemblies for 114A00-1 interface.12 pack.	18.83



LSA110A00-2



LSA112A00-1



LSA111A00-1



LSA114A00-1

Omni-Bus Keypads

LEVOBKND-10W	1-button Omni-Bus Decora low voltage keypad, NEMA form factor, white	74.94
LEVOBKND-20W	2-button Omni-Bus Decora low voltage keypad, NEMA form factor, white	74.94
LEVOBKND-40W	4-button Omni-Bus Decora low voltage keypad, NEMA form factor, white	74.94

Call for additional colors and engraving information



LEVOBKND-10W



LEVOBKND-20W



LEVOBKND-40W

- These hard-wired Omni-Bus keypads are wired using Cat5e/6
- Push Button On/Off control
- Custom engraving available
- Can be daisy-chained for a more seamless and easy installation
- The last device in the daisy chain needs a jumper to complete the circuit
- Buttons can operate a load or a scene on the Omni-Bus system
- Can control any load type including CFL, LED, Incandescent, Electronic Low Voltage, and Halogen
- Currently only available in white.

Omni-Bus Wireless

LSA115A00-1	Omni-Bus RF Wireless Transceiver	97.35
-------------	----------------------------------	-------

- Omni-Bus wireless transceiver creates the ability to use wireless devices on the Omni-Bus network.
- This supports up to 256 devices including keypads and keyfobs.



LSA113A00-2	1-Button Omni-Bus wireless keypad	46.68
LSA113A00-4	2-Button Omni-Bus wireless keypad	54.14
LSA113A00-7	3-Button Omni-Bus wireless keypad	63.44



LSA113A00-2



LSA113A00-4



LSA113A00-7

Key Fobs

LSA125A00-1	6-Channel Omni-Bus key fob - Green	34.56
LSA125A00-2	6-Channel Omni-Bus key fob - Red	38.90



LSA125A00-1



LSA125A00-2

Omni-Bus Enclosures

Can accommodate Omni-Bus modules or any other DIN rail mount load control or other 3rd party control equipment that is ANSI-standard. Vented enclosure. ETL and UL listed to UL and CSA Standards as an Industrial Controls Equipment Enclosure.

LSADINRK-001	1 Rail: 3 modules total	41.58
LSADINRK-A03	3 Rail: 5 modules per rail, 4 modules if 17A00-1 is used	181.90
LSADINRK-A06	5 Rail: 6 modules per rail, 5 modules if 17A00-1 is used	CALL



LSADINRK-001



LSADINRK-A03

Omni-Bus Accessories and Accessory Modules

These devices are supplemental to but not required for your Leviton Omni-Bus installation.



LSA126A00-1



LSA119A00-1



LSA118A00-1

LSA126A00-1	Omni-Bus Scene Control, stores button scene information. Can be used for stand-alone installations or with an Omni controller - DIN Rail Mount.	138.74
LSA118A00-1	Omni-Bus Digital Addressable Lighting Interface (DALI) Module, includes On/Off switching, dimming, group, broadcast and scene commands - DIN Rail Mount	148.34
LSA116A00-1	USB Programming Interface + software license	245.62
LSA119A00-1	Omni-Bus 3-way splitter	21.94
LSA95A20-1	Single-gang metal switch box	10.05



Need help designing an Omni-Bus lighting system?
Give us a call at 800-282-8864.



Controller Mounting Package

The best way to take your installation to the next level of professionalism is to use these great products from Leviton. Structured wiring is important and adds unlimited value for trouble shooting purposes and service work after the install.

We understand and appreciate the value of a proper installation. Let us say thank you by extending a discount! For less than \$225 you can have everything to mount your favorite Omni in a structured wiring cabinet.

10% Off All Year!

Purchase an Omni Mounting Kit and save 10% off our dealer price.



LEV47612-UBK



UB1270



LEV47605-ACS



ELKTRG2440

LEV47605-42N	42" enclosure only	64.55
LEV47605-42S	42" vented hinged door	65.66
LEV47612-42B	Extender bracket for 42 inch enclosure, adds 2 inch depth	41.94
LEV47612-UBK	Universal battery bracket	26.82
LEV47605-ACS	Surge protected, 2-outlet	23.13
LEV47605-ACN	Non-surge protected, 2-outlet. Great for UPB.	10.05
ELKTRG2440	Transformer, 24VAC, 40VA	10.40
UB1270	Battery, rechargeable, 12V, 7Ah	13.10
		Regular dealer price 254.64
LEVOMNISWKIT	Omni Mounting Kit. Must be purchased together for discount.	229.15



Controller Hardware Accessories



LSA20A07-2



ELK1280



LSA21A06



LSA103480

LSA103480	16 piece pack of 1000 Ohm resistors	1.29
LSA20A07-2	Structured Wiring Plate for Omni Pro II, Ile, LTE, and 17A00 Expander, fits Leviton, Open House, Legrand, and UStec enclosures	43.64
HAIENLG	Enclosure only for Omni Pro II, Ile, LTE and 17A00 Expander. Must add keys and lock.	28.68
LSA21A06	Enclosure lock and keys	9.30
PRBTM5D4-W	1x4 - 110 block - on-wall mount enclosure	13.88
ELKTRG2440	Transformer, 24VAC, 40VA, auto-resetting, grounded, use with LSA Controllers	10.40
ELK1280	Battery, rechargeable, 12V, 8 Ahr	18.54

Got What it Takes?

Do you measure up with some of the best in the industry? Check out the wiring below of a Leviton structured wiring enclosure. Keep an eye out for our 2018 installer contests this year!



Joe Weber, J n J Security & Contracting
Hondsdale, PA

Relay Modules

LSA10A07	4-relay module with mounting tape	48.63
LSA19A00	8-relay module with mounting tape	78.77
LSA19A00-1H	8-relay module with controller mounting kit	78.67



Omni controllers and expanders use 12VDC triggers. For dry contact closure, add a relay board.

Firmware Chip Upgrades

LSA20A04-2	OmniPro II Chip Upgrade		53.19
LSA20A04-50	Omni Ile Chip Upgrade		53.19
LSA20A04-1	Omni II Chip Upgrade		53.19

Call to determine if you need a chip upgrade. New controllers use flash. For questions about legacy Aegis and OnQ panels give us a call!

Software

LSA1105W	Dealer Software for Windows®, for the Omni family of controllers	130.91
LSA1106W	End User Software for Windows, without dealer sections	48.51

Snap-Link provides remote access for OmniPro II, Ile. Includes a skin for PC touchscreens and free updates for registered users. Snaplink is available on the iOS and Android app stores.

Snap Link Mobile

Snap Link Mobile puts home and business control in the palm of your hand with zero monthly fees! Simply purchase the app from the store and get instant access to your Leviton automation system. You can even access multiple properties from a single app.

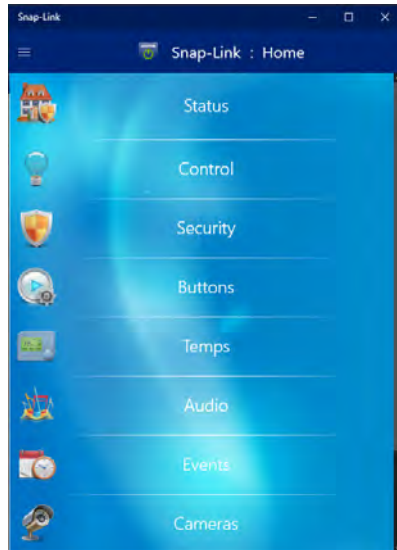

Zero monthly fees!



Available through your favorite App store for Android, iOS, and Windows 10 devices.

Heavy Load Control Modules



LSA72A00-1



LSA71A00-1

LSA72A00-1	12VDC input 20A load control module	53.91
LSA71A00-1	HLC 30A 120/240 load control module	266.09

Cellular and Internet Communicators



TELGUARD

Telguard communicators connect to any alarm panel's phone terminals. The panel thinks it is dialing a central station, but the Telguard intercepts the dial out and transmits it to their data center. From there, dealers can set to forward to a central station of their choice or automatically notify their customers by email or text message.



TELTG1LX001	TG-1 Express Verizon LTE, Primary Cell	138.64
TELTG1G0004B	TG-1B AT&T, Primary or Backup	151.13

NAPCO

- Full event reporting from any panel, anywhere, field-proven to work virtually anywhere in US, on Panels using Contact ID or 4/2.

-Reports to any Central.

- No radio activation fee. No special equipment.

- Primary or Backup Alarm Communications. Backup Mode supervises telco and only sends GSM reports when it's not functioning



NAPSLECDMA	Starlink Up/Downloadable Verizon Universal Alarm Communicator	99.87
------------	---------------------------------------------------------------	-------

Text and Email Notification Board

Features

- Send email or SMS texts based on any programming line
- 100 User Programmable Messages
- 8 Customizable Email Addresses
- Adds Network Time Sync to Omni/Lumina Controllers
- **No service fees or contracts**



LSA20A30-1	Omni Notifier, supports Omni/Lumina controllers with Ethernet	119.69
------------	---------------------------------------------------------------	--------

Serial Boards and Cables

LSA10A17-1	RS-232/485 Serial Board, max 1 per system	166.25
LSA21A05-2	7' RJ11 line cord with modular RJ11 to DB9 adapter (programming cable)	13.24
LSA36A05-4	RJ-11 to DB-9M straight through serial. Use with Russound, Lutron, RadioRA 2, Jandy & CentraLite	14.72
LSA36A05-2	Serial PC to LSA UPB PIM (UpStart)	21.22
BL180503	DB9F to DB9F 6' null cable for 10A17-1 Serial	1.22
ELKUSB232	USB to RS-232 interface. Requires LSA21A05-2.	23.95



LSA10A17-1



BL180503



LSA36A05-4



LSA21A05-2

ELK M1 Gold Basic Controllers

ELKM1GOLD	M1 Gold Controller in 14" Enclosure	358.24
ELKM1GCB	M1 Gold Control board only (in clam case). Terminal strips not included.	335.95
ELKM1BLOCKS	Replacement plug-in terminals for M1 Gold	15.33

ELK M1 Gold Installation Kits



ELKM1GSYS4

ELKM1GSYS4S

ELKM1GSYS3	Includes: M1 Gold in enclosure, transformer, battery, speaker, and RJ31X. No keypad.	385.42
ELKM1GSYS4	Includes: M1 Gold in enclosure, transformer, battery, M1KP keypad, speaker, and RJ31X	497.24
ELKM1GSYS4S	Includes: M1 Gold in enclosure, transformer, battery, M1KP2 keypad, speaker and RJ31X	477.24
ELKM1GK	Includes: M1 Gold, transformer, M1KP keypad, battery, speaker, and RJ31X. No enclosure.	475.95
ELKM1GKS	M1 Gold, transformer, M1KP2 Keypad, battery, speaker, and RJ31X. No enclosure.	455.95

ELK Two-Way Wireless Kits



ELKM1GSYS4STW

ELKM1XRFTWKIT

See the next page for more ELK Two-Way Wireless accessories.

ELKM1GSYS4STW	Includes: M1GSYS4S kit, M1XRFTW transceiver, and 6010 key fob	520.19
ELKM1XRFTWKIT	Includes: M1XRFTW transceiver, (2) 6010 key fobs, (2) 6020 slimline door/window sensors, and (1) 6030P motion with pet immunity	258.75

ELK Mounting Accessories

ELKSWB14	14" structured wiring enclosure, hinged door	28.21
ELKSWFD14	Flush mount door for the 14" enclosure	21.23
ELKSWB28	28" structured wiring enclosure, hinged door	70.76
ELKSWNS1	Nylon standoffs, 1/4" spacing, fits .156" hole	4.74
ELKSWS	Battery shelf	9.64
ELKSWP3	Mounting plate for M1 boards	6.76

ELK products are listed at MAP.

Please log in to the Worthington Distribution Dealer Store, email us, or call us for your low dealer pricing.

What's Under ELK's Hood?



M1 Gold Specifications

Voice Capability - Voice announcements for alarms, descriptions, status, etc. with an integrated voice dialer	Yes
On-board Input Zones with maximum expansion	16 208
On-board Outputs with maximum expansion	13 (1 form C relay) 205
Built-in Serial Port	Yes
Power Terminals	4 Total: 3 Auxiliary, 1 Switched
Master Power Switch and Low Battery Disconnect	Yes
Keypad Diagnostics	Zone Voltage Display and Volt/Current Meter
Two-Way Listen-In Capability	Central Station Alarm Verification User Activated through Telephone
Automation ("Whenever/And/Then") Rules Capacity	528
Maximum Keypads Supported	16
Flash Updated Firmware	Yes
Vocabulary	500+ Words and Phrases
Custom Words and Phrases	Yes
Removable Terminal Strips	Yes
Serial (RS232) ports supported	8
Maximum thermostats supported	16
Total wireless zones	144
Total number of users supported	199
Remote Options: Apple, Android, Cloud Service, and PC	Yes (requires the M1XEP)
E-mail Notifications	Yes (requires the M1XEP)
Advanced lighting options	Yes
Analog zone definitions supported	Yes
Ability to create custom Serial ASCII strings	Yes
Z-Wave Lock Support	Yes
Sunset / Sunrise	Calculated
Time-stamped Event History Log	512
Menu-driven keypad programming	Yes
Smoke Detection	4 wire (any zone) 2 wire (zone 16)
Maximum Security Partitions	8
Distributed Audio Support	Russound, Nuvo, Proficient
Auxiliary Power	1 amp continuous
Overload Protection	PTC (fuseless), resettable
UL Listings	Residential Burglary & Fire Commercial Burglary

ELK M1 Interfaces

	ELKM1KPNV	ELKM1KP*	ELKM1KP2	ELKM1KP3	ELKM1KPAS	
See next page for keypad accessories.						
	Description	Navigator 3.5" color touchscreen keypad	LCD keypad. 16 character, 2-line screen. * LCD color: blank-green, B-blue	Low-Profile LCD keypad. 16 character, 2-line Blue screen. Flush-mount option.	Low-Profile LCD keypad with cover. 16 character, 2-line Blue screen.	Decorator arming station with status LEDs
	Physical Dimensions	4.25"W x 3.38"H x .59"D	6.87"W x 5.25"H x 1.32"D	4.65"W x 5.5"H x 1"D	3.97"W x 5.43"H x 1.19"D	1.81"W x 2.75"H x 1"D
	Door Cover	No	Yes	No	Yes	No
	Zone Input	Yes (1)	Yes (1)	Yes (1)	Yes (1)	No
	Programmable Output	Yes (1)	Yes (1)	Yes (1)	Yes (1)	No
Optional 26-Bit Wiegand Proximity Reader	No	Yes- Internal & External	Yes- External Only	Yes- External Only	No	
Internal Temp Sensor	No	Yes	No	No	No	
Function "F" Keys	6	6	4	4	6 (uses "F" key)	
LCD Display	Full color, touch	Green or Blue	Blue	Blue	N/A	
Key Backlighting	N/A	Amber	Blue	Blue	Blue	
Mounting Options	Surface Mount Only	Surface Mount Only	Surface or Flush Mount	Surface Mount Only	Standard Electrical Box	
Price	185.00	115.95	95.95	107.56	70.92	

ELK M1 Two-Way Wireless Security

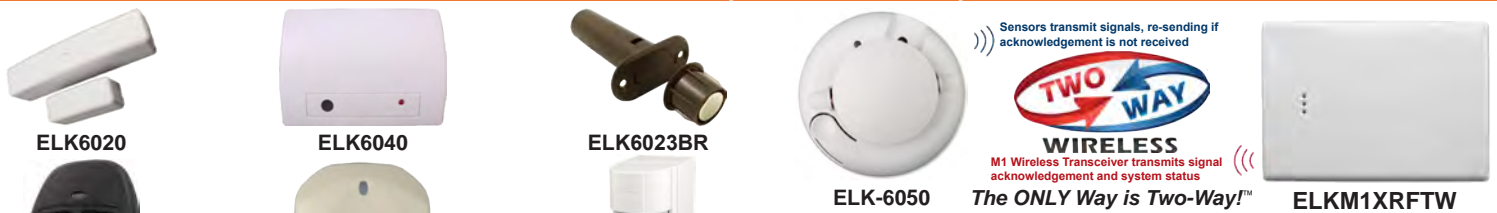

ELK6020

ELK6040

ELK6023BR

ELK-6050

ELKM1XRFTW

Sensors transmit signals, re-sending if acknowledgement is not received

WIRELESS
M1 Wireless Transceiver transmits signal acknowledgement and system status

The ONLY Way is Two-Way!™

ELK6010

ELK-6011

ELK6032

ELKM1XRFTWM	144 zone two-way wireless transceiver. For use with ELK two-way transmitters.	99.95
ELK6010	Two-way four button keypad	38.65
ELK-6011	Two-way water resistant panic button, lanyard	37.95
ELK6020	Two-way slim line door/window sensor, white	37.76
ELK6020BR	Two-way slim-line door/window sensor, brown	37.76
ELK6021	Two-way mini door/window sensor	35.05
ELK6022	Two-way universal 3-zone sensor	52.21
ELK6023	Two-way recessed door contact, white	38.95
ELK6023BR	Two-way recessed door contact, brown	38.95
ELK6030	Two-way motion detector	75.95
ELK6030P	Two-way pet-immune motion detector	84.49
ELK6032	Two-way outdoor motion detector	239.95
ELK6040	Two-way glass break	81.95
ELK-6050	Two-way smoke and 135° heat detector	89.95

TECH TIP:

With ELK two-way wireless smokes, if one detector senses smoke, the sounders in all of the detectors will go off.

	True two-way signal confirmation.		Status LEDs provide system information and installation confidence.
Encrypted to defend against interference, hacking, and jamming.		900 MHz frequency hopping ensures signals get through.	

Avoid the vulnerability of traditional wireless sensors with ELK's Two-Way Wireless technology.

Scan the QR code to learn more about the benefits to using ELK's Two-Way Wireless.



ELK M1 Keypad Accessories

ELKM1BBKN	Surface-mount back box for M1KPNV	6.95
ELKM1BZBKN	(2) Black color change kits for the M1KPNV	11.95
ELKM1BZSKN	(2) Silver color change kits for the M1KPNV	11.95
ELKM1BBK2	Flush mount backbox for the M1KP2 keypad	6.09

ELK M1 Access Control



ELKM1KAM

ELKM1KAM Door access module. Use in place of a keypad, support for 26 bit Wiegand readers, Dallas iButton, Form "C" Relay, 3 indicator outputs, 2 inputs and selectable time settings for door hold and request to exit. 92.12



ELKM1PRC/ELKM1PRF

ELKM1PRC Pack of 10 proximity cards 29.50
 ELKM1PRF Pack of 10 proximity fobs 49.95
 ELKM1PR Internal Wiegand-compatible proximity reader for M1KP keypad 53.95



ELK106055

ELK106055 Surface-mount external proximity reader for ELKM1KAM or compatible M1 keypads 59.95
 ELKW035A Wire harness for connecting ELK106055 to an M1KP or M1KPB keypad 2.50
 ELKW039A Wire harness for connecting ELK106055 to an M1KP2 or M1KP3 keypad 2.50

Need mag-locks or door strike devices for your ELK system? See Alarm Controls and Seco-Larm on page 137 for options.

ELK M1 Lighting/Thermostat Integration

Truly Unbiased Integration



ELKM1XSP

Because ELK doesn't make their own lighting control products or thermostats, they can offer unbiased integration with all of their Integration Partners.

The M1XSP serial port expander is a three-in-one product which provides an additional remote serial port, integration for serially controlled lighting systems, or adaptor for communicating thermostats.

Check out ELK's website for a list of Integration Partners.

ELKM1XSP	Serial port expander	76.95
----------	----------------------	-------



ELKM1XSLZW

ELKM1XSLZW M1 to Z-Wave serial interface, VRC0P-1LW required, sold separately, see page ** 104.95



ELKM1XSLU

ELKM1XSLU M1 to Lutron RadioRA 2 serial interface 209.95



ELKM1XSLC

ELKM1XSLC M1 to Lutron Caseta serial interface 249.95

ELK products are listed at MAP.

Please log in to the Worthington Distribution Dealer Store, email us, or call us for your low dealer pricing.

ELK M1 Communication Interfaces



ELKM1XEP

ELKM1XEP Ethernet port - for programming, monitoring, e-mail notification, and remote control 163.95



ELKC1M14GSM

ELKC1M14GSM Dual-Path Communicator. Communicates via IP and cellular to central station monitoring and allows local or remote programming. 289.95



ELKIP232

ELKIP232 IP to serial Interface 128.83

ELK M1 Input and Output Expanders

ELKM1XIN	16 zone input expander	71.95
ELKM1XOVR	Output expander, 8 relays, 8 voltage outputs	106.95
ELKM1RB	Relay board, 8 form "C" relays for use with ELKM1XOVR, or M1 controller	56.50
ELKW018B	4-pin cable for connecting expanders at the M1 controller	2.69
ELKM1XRFEF	144 zone wireless receiver. For use with Interlogix transmitters.	99.95
ELKM1XRF2H	144 zone wireless receiver. For use with Honeywell 5800 series transmitters.	99.95

ELK M1 Databus Wiring Hubs

ELKM1DBH	Passive wiring hub. Use with 8 conductor cable (Cat 5) to connect keypads and expanders.	29.81
ELKM1DBHR	Retrofit hub for 4 conductor wiring. Connect 4 bus branches per hub (2 hubs per system).	54.95

ELK M1 Temperature Accessories



ELKM1ZTS

ELKM1ZTS Temperature sensor. Max 1 per zone, wire to zones 1-16. 53.95



ELKM1ZTSR

ELKM1ZTSR Remote temp sensor. Stainless steel bullet on a 7' cable, max 1 per zone, wire to zones 1-16. 75.95

ELK M1 Motorized Water Valve

ELKWSV2	12VDC Water valve with 1" fittings	359.95
ELKP1417	14VDC 1.7 Amp power supply	19.99

- Rapid Action - Opening and Closing
- Manual Override Handle
- Connections: 18 gauge, 4 conductor cord
- Stainless Steel Grade 316 Safe for Drinking Water
- Integrate with security system or on/off pushbutton



ELKWSV2

ELK M1 Software

ELKRP	Programming software (Free download)	Free
ELKUSB232	USB to RS-232 serial adapter	23.95

M1ToGo Free PC Software

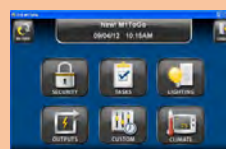

M1ToGo software provides internet remote access from a Windows® based PC to M1 systems from anywhere in the world. Users can access security, lighting, energy management, door access and any other systems connected and controlled through the M1. Download M1ToGo from the ELK web site.

Aprilaire Connected Home Products

For 75 years, Aprilaire has been committed to the success of HVAC contractors by providing solutions designed for consumer health, comfort, protection and energy savings. Their new line of Wi-Fi thermostats continues that tradition. Clean and simple, the Aprilaire Wi-Fi Thermostat app has intuitive temperature control features designed so anyone can understand and use them to effectively deliver comfort and energy savings.

But that's not all. Aprilaire, the #1 provider of indoor air quality solutions, also offers SmartIAQ: the ability to balance all aspects of indoor air quality, including Temperature, Humidity, Air Purity, and Fresh Air. (IAQ = Indoor Air Quality)

APR8800	Universal Communicating Programmable Touchscreen Thermostat 2 Heat / 2 Cool, or Heat Pump 4 Heat / 2 Cool (RS485)	243.58
APR8810	Wi-Fi Automation Thermostat with Event-Based™ Air Cleaning 2 Heat / 2 Cool, or Heat Pump 4 Heat / 2 Cool	140.14
APR8820	Wi-Fi Automation Thermostat with Integrated IAQ solution 2 Heat / 2 Cool, or Heat Pump 4 Heat / 2 Cool	191.10
APR8830	Touchscreen Wi-Fi Automation IAQ Thermostat 3 Heat / 3 Cool, or Heat Pump 4 Heat / 2 Cool	242.06
APR8840	Color Touchscreen Wi-Fi Automation IAQ Thermostat 3 Heat / 3 Cool, or Heat Pump 4 Heat / 2 Cool	318.50
APR8081	Temperature support module, supports 2 temperature readings (8051, 8052, 8053) for averaging and/or monitoring	71.12
APR8082	Surface Temperature/relative humidity module, supports 1 temp. and 1 RH reading, can be remoted using 8051, 8052, 8053	102.04
APR8083	Flush-Mount Temperature/relative humidity sensor that will work with the 8800, 8820, 8830 and 8840	99.92
APR8051	Flush-mount temperature sensor for use with 8800, 8081/82	15.01
APR8052	Duct-mount or outdoor temp sensor for use with 8800, 8081/82	4.97
APR8053	Surface-mount temperature sensor for use with 8800, 8081/82	10.72
APR8819	Communication distribution panel - supports (8) RS485 thermostats	104.72
APR8029	24VAC, 40VA transformer with protection	15.29
APR8811	RS-485 to RS-232 Protocol Adapter - supports 32 thermostats	99.55



APR8800



**APR8820 APR8620W
APR8830 APR8910W**



APR8819



**APR8810
APR8476W**

Proud Partners with These Top Integration Specialists



APR8082



APR8840

Wi-Fi Thermostats Work with the Aprilaire Wi-Fi Thermostat App

APR8476W	Universal Wi-Fi Programmable Thermostat with Event-Based™ Air Cleaning	92.93
APR8620W	Universal Wi-Fi Touchscreen Thermostat with Event-Based™ Air Cleaning and Humidity or Ventilation Control	139.39
APR8910W	2 Part Universal Wi-Fi IAQ Thermostat with LCD Touchscreen	180.11
APR8920W	Color Touchscreen Wi-Fi IAQ thermostat works with the Aprilaire Wi-Fi Thermostat App	261.42



**WORKS WITH
amazon alexa**

Non-Communicating Thermostats

APR8620	Universal Touchscreen Thermostat - 2 Heat / 2 Cool, or Heat Pump 4 Heat / 2 Cool	133.62
APR8710	Wireless Programmable Thermostat - 2 Heat / 2 Cool or Heat Pump 3 Heat / 2 Cool	134.89
APR8444	Standard Non-Programmable Thermostat - 1 Heat / 1 Cool	33.07
APR8446	Heat Pump Non-Programmable Thermostat - 2 Heat / 1 Cool	35.80
APR8448	Universal Non-Programmable Thermostat - 2 Heat / 2 Cool or Heat Pump 3 Heat / 2 Cool	47.74
APR8463	Standard Programmable (5+2 Day) Thermostat - 1 Heat / 1 Cool	43.32
APR8465	Heat Pump Programmable (5+2 Day) Thermostat - 2 Heat / 1 Cool	46.38
APR8466	Universal Programmable Thermostat - 2 Heat / 2 Cool or Heat Pump 3 Heat / 2 Cool	57.65



APR8710



APR8400 Series

Smarter.

Introducing 200 Series

wall dimmers • switches • fan controllers

Set indicators to glow or blink different colors when things happen in the home

Status Mode

- Pool Pump Running — 
- Motion in Garage — 
- Front Door Closed — 
- Back Door Open — 
- Side Door Unlocked — 

HS-WD200+
wall dimmer

Normal Mode

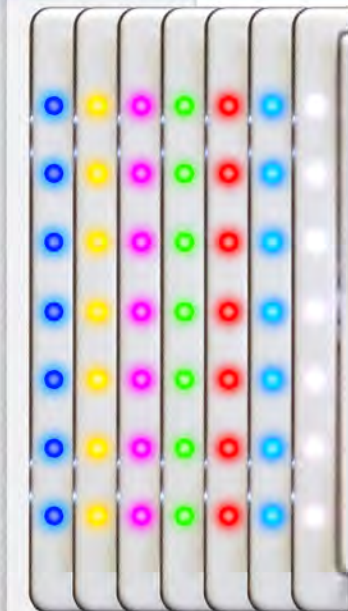

Features

- Programmable Indicators
- Multi-tap Triggers (1-5 taps)
- S2 Security Encryption
- Screw Terminal Installation

Match indicator colors with existing switches or change colors based on personal preference or special events



controllers • switches • sensors • smart valves • more

HomeSeer | 10 Commerce Park N, Suite10, Bedford, NH 03110 | 603.471.2816

HomeSeer
www.homeseer.com

2500 Series Kits (1/2 mile range*)

DADCPA-2500	Wireless Driveway Probe Alert, 50' Cable, PT-2500 transmitter and DCR-2500 receiver, includes 4x CR123-A batteries, 1/2 mile range,* reminder beep/LED, and counter	168.62
DADCMA-2500	Wireless Motion Alert, 1/2 mile range,* MT-2500 transmitter and receiver, requires one 9V battery, reminder beep/LED, and counter	88.68
DAUTDCR-2500	Universal Transmitter Kit. Can be used as Panic Button or as a Wireless Doorbell. Includes magnet for use as Wireless Door Contact. Also contains inputs for both N/C and N/O sensors. Includes DCR-2500.	74.94
DAIRDCR-2500	Wireless PIR Kit 1/2 mile range,* transmitter and CR-2500 receiver, requires one 9V battery, reminder beep/LED, and counter	89.93
DABBA-2500	Break Beam Kit 1/2 mile range,* transmitter and CR-2500 receiver. Solar recharging of the batteries extends operating time.	223.57

*Range varies due to terrain/objects that can cause RF interference.



DADCMA-2500



DADCPA-2500



DABBA-2500



DAUTDCR-2500

2500 Series Expansion (1/2 mile range*)

With 4 Channels available, you can add more transmitters to expand your coverage. Mix and match transmitters to your needs.

DABBT-2500	Solar-Recharged Wireless Break Beam sensor-transmitter, use with DCR-2500 or PR-2500	188.60
DAUT-2500	Universal Transmitter. Includes magnet for use as Wireless Door Contact. Also contains inputs for both N/C and N/O sensors.	29.98
DADCMT-2500	Motion Transmitter (Green Box). Can hide in foliage for hidden detection.	51.21
DADCPT-2500	Driveway Probe with Transmitter and 50' cable. 1/2 mile range,*	133.64
DAIR-2500	Wireless PIR (White Box) Good to wall-mount on the porch	57.45
There is no limit to the number of receivers you can use. Have one on each floor and in out buildings. The portable model can hang on your belt.		
DADCR-2500	Plug-in Receiver for 2500 series	49.96
DAPR-2500	Portable Battery-Powered Receiver for 2500 series	52.46



DAPR-2500



DAIRDCR-2500



DAUT-2500

MURS (Multi-Use Radio Service) Alert (Several mile range*)

DAMAT	MURS PIR transmitter, for mounting on a tree or post, requires six AA batteries	98.67
DAM538-HT	MURS Hand-Held Transceiver, receives alerts from MURS devices as well as two-way communication w/ other transceivers, includes charger and batteries	73.63
DAMURSHTKIT	MURS MAT Kit, includes one PIR transmitter and one M538-HT transceiver	165.49
DAMAPS	MURS Alert Probe Sensor transmitter, 50' direct burial cable	198.59
DAMAPSHTKIT	MURS MAPS Kit, includes one probe transmitter and one M538-HT transceiver	264.16
DAMURSCHIME	MURS Chime Module for M538-BS, connects to NO output, requires two AA batteries	11.24

Coming Summer 2018:

The Dakota Alert Smart Push is an easy to install Wi-Fi push notification module that can be used with the Dakota Alert DCR-2500 or any control panel that has NO or NC outputs. The Smart Push will send a push notification to the Dakota Alert app (Android or iOS) running on your smart phone any time one of the input zones is activated. The Smart Push has four hard wired inputs that the user can identify and name through the app. The push notification that appears on the user's phone will give the time and date of activation as well as the custom alert message that the user creates. Part number and price to be announced in June.

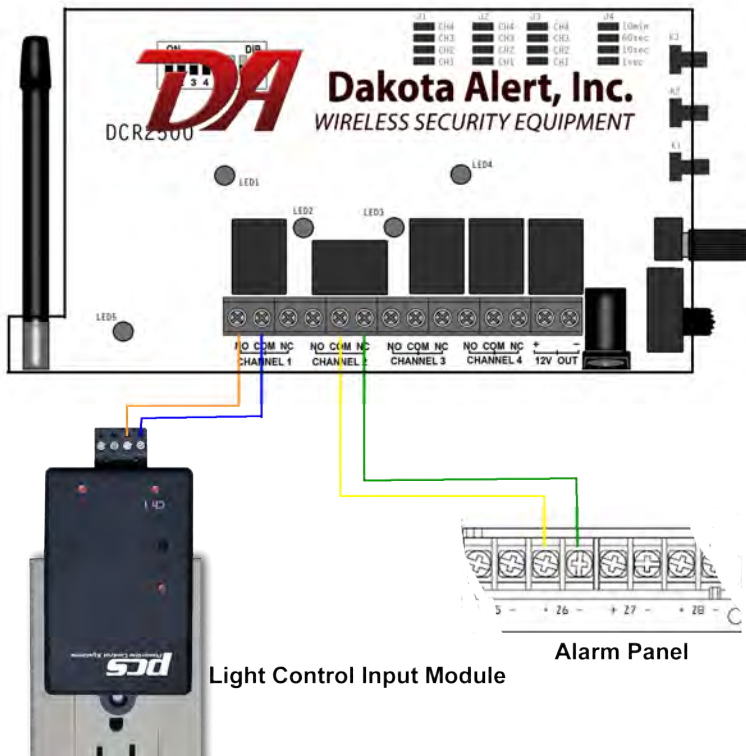

Alarm Panel

Light Control Input Module



STORE VIDEO TO THE U.S. BASED SPECOCLOUD STRAIGHT FROM SPECOCLOUD-ENABLED IP CAMERAS

Speco Technologies is excited to offer cloud storage at competitive rates through the Speco Cloud. Using Speco's Cloud-Enabled IP cameras you can access your home or business using our customizable Speco Cloud App available in the app store today! With its easy install, simple app setup, convenient monitoring, secure cloud storage, Speco Cloud products prove to be real security at your fingertips!

Store Video in the Speco Cloud with **Competitive Storage Rates**

Value-Added Features like **Customizable Speco Cloud App**

Real & Reliable Video Surveillance **Vandal Resistant Cameras**



O4VLB5 bullet
O4VLD5 dome
2.8mm fixed lens



O4B6M bullet
O4D6M dome
3.3-12mm motorized lens,
micro SD card slot



- Built-in standard PoE (IEEE 802.3af)
- H.265/H.264/MJPEG compression supported
- Adaptive IR LEDs reduce IR saturation
- IP66 compliant, weather resistant
- Junction boxes included with all models



VIEW SITES THROUGH CUSTOMIZABLE SPECOCLOUD APP



Display your logo throughout the Speco Cloud app at no additional charge. **Download Speco Cloud in your app store today!**

REAL RMR FOR REAL SECURITY PROFESSIONALS

Backed by a company with over 60 years of experience in the security industry. We are providing an **NEW** opportunity for yet another way to **INCREASE YOUR PROFIT WITH EVERY INSTALLATION!**

speco technologies
Giving You More.

1.800.645.5516



Become a Channel Partner Today!
visit specotech.com

Self-Contained Vehicle Sensors - Bury 50' from Cross-Traffic



CTCP-3-100-5W	Self-contained unit w/ 100' cable, requires power from supply or security panel	162.99
CTCP-3-200-5W	Self-contained unit w/ 200' cable, requires power from supply or security panel	233.25
CTCP-3-300-5W	Self-contained unit w/ 300' cable, requires power from supply or security panel	303.51
CTCP-3-500-5W	Self-contained unit w/ 500' cable, requires power from supply or security panel	444.02
MGT12500SPS	Power supply for self-contained Cartell detector, 12VDC 500mA	4.93

Installation is as simple as burying the probe, which is 21" long and 2" diameter, 6" to the side of the driveway. Bury the included and connected direct burial wire up to the house. Then connect two conductors to a 12VDC power supply, and the remaining two conductors to an input of your favorite controller. Also connects directly to gate operators to provide free exit.

Controllers - Use with CT6 and Short Driveway Probes



CT2B	Controller, adjustable sensitivity, enclosure, power supply, manual	137.70
CTCF2C	Controller, adjustable sensitivity, 15A/120VAC timer relay, enclosure, power supply, manual	223.88

When using the CT2B/CTCF2C controller, mount the controller next to the security system or automation controller. Splice using only CTCA1. Multiple probes can be wired to a controller; the controller closes a contact when motion is detected on any of the probes.

CT6 Probes - Bury 50' from Cross-Traffic



CT610	Probe with 10' cable, requires a Cartell controller, use CT2B or CTCF2C listed above	33.72
CT650	Probe with 50' cable, requires a Cartell controller, use CT2B or CTCF2C listed above	44.96
CT6100	Probe with 100' cable, requires a Cartell controller, use CT2B or CTCF2C listed above	65.57
CT6150	Probe with 150' cable, requires a Cartell controller, use CT2B or CTCF2C listed above	87.12
CT6200	Probe with 200' cable, requires a Cartell controller, use CT2B or CTCF2C listed above	108.66
CT6250	Probe with 250' cable, requires a Cartell controller, use CT2B or CTCF2C listed above	130.21
CT6500	Probe with 500' cable, requires a Cartell controller, use CT2B or CTCF2C listed above	237.93
CT61000	Probe with 1000' cable, requires a Cartell controller, use CT2B or CTCF2C listed above	453.39
CT61500	Probe with 1500' cable, requires a Cartell controller, use CT2B or CTCF2C listed above	668.84
CT6A	Detached probe, requires a Cartell controller and Cartell direct burial wire	66.51
CTCA1	Epoxy-based splice kit, 3M product	56.20

Short Driveway Probes - Bury 10' from Cross-Traffic

CTSD610	Short driveway probe with 10' cable, requires a Cartell controller, use CT2B or CTCF2C listed above	86.18
CTSD650	Short driveway probe with 50' cable, requires a Cartell controller, use CT2B or CTCF2C listed above	97.42
CTSD6100	Short driveway probe with 100' cable, requires a Cartell controller, use CT2B or CTCF2C listed above	112.41

Annunciator Plates

CTA1	Sleek hardwired annunciator, mounts in 1-gang box, volume control and mute, 3 tones to identify different driveways	70.26
CT-11	Outdoor annunciator plate, weatherproof	79.62



Photocells

CTFC6	Self-stick Photocell, attaches to inside of window, use with CTCF2C	17.80
CTFC12	Outdoor photocell, weatherproof, use with CTCF2C	32.79

Dealers will tell you that vehicle detection is the one system enhancement that all customers rave about. Worthington Distribution endorses Cartell vehicle detectors by Preferred Technologies for their outstanding performance. Cartell vehicle detectors provide announcement, the ability to perform lighting control and video switching control.



LSA20A30-1 Omni Notifier Board, See Page 86

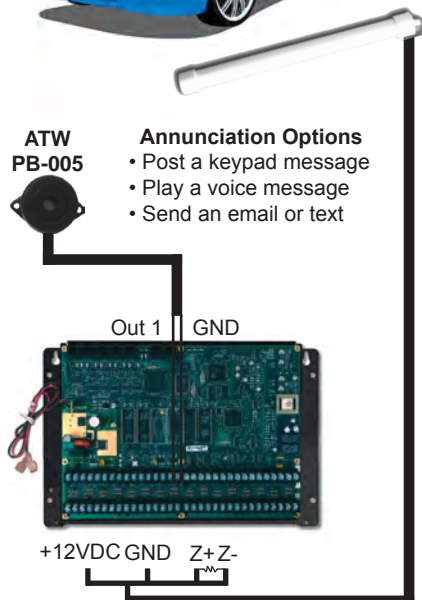
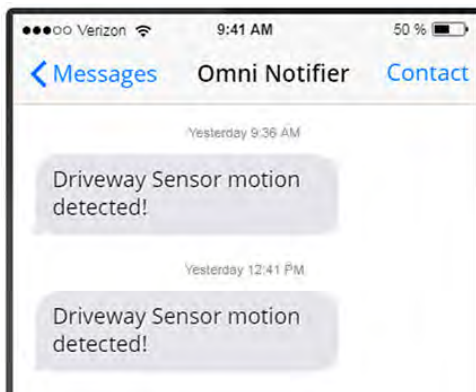

- Annunciation Options**
- Post a keypad message
 - Play a voice message
 - Send an email or text



Resolution Helix

Helix is the first professional security panel designed to deliver interactive security and home automation services from a customer's mobile device. Unlike a hybrid panel, dealers don't need to pull wires for peripheral devices or other sensors.



Page 89



Fully Integrated Security

2GIG is revolutionizing the security industry by integrating GSM and broadband communication (no phone line needed), wireless security, Z-Wave automation, 2-way voice, and a high resolution touchscreen in a single package.



Pages 113-116



PowerSeries Hybrid

As of version 4.6, the PowerSeries controller will now support 2-way wireless. DSC makes it easy for you to stay ahead of the technology curve with the easiest to sell, easiest to install and easiest to use security systems anywhere.



Pages 117-121



Commercial and residential

Fire, Burglary and Security Control Alarm, Video, Temperature, Lighting & Locking via Z-Wave: New App for iPhone/Android and/or New Touchscreen/Tablet provide services your customers will love!



Page 127-129

Fire Supervision

For residential, the most common types of fire supervision are smoke detectors. Heat detectors and carbon monoxide detectors are also desired in some installations. Whether you are doing smoke-only or a full blown fire system, you must be sure to follow all local, state and national codes. Doing so will not only protect the homeowners, but it will protect you and your company as well. Life safety is the most important part of monitoring a home.



Wireless

Wireless devices are available from almost every manufacturer that makes a security system. While not as reliable as hardwired, wireless allows you to complete installations where a security zone was not designed to be. Wireless is the preferred choice for retrofit applications as well. DSC offers their Neo system which is completely wireless, including the keypads and sirens, which are a limitation of traditional wireless.



Wireless Locks

Wireless locks are available for use with 2GIG Go Control Panels as well as Napco and Resolution Helix (additional module required). When a code is entered on the pinpad, the door will unlock and a signal can be sent to the security panel to disarm the system. No more having to enter codes twice or worry about running out of time to disarm due to fumbling with keys.



Security Devices

There is a security device for almost any application. Magnetic contacts protect doors and windows, motion detectors monitor areas where no one should be, smoke detectors help with life safety, and glass breaks add further protection to doors and windows. These are just a few examples. For a complete security system, a combination of all of these devices works best.



Access Control

Whether you are trying to allow easy entry to a home or are trying to prevent unauthorized people from getting in, access control covers both situations. Either by using a keypad or a reader, you limit who has access. Some systems integrate cameras to be able to view who is at the door and most systems allow for many user codes. In some cases, levels of access are available.



Keri Systems access control systems are the perfect choice for 1 to 256 doors. Networked controllers make routine maintenance like adding and removing users or modifying schedules easy for building managers.



Page 136

Panels

The heart of any security system is the panel. Panels should be placed in a somewhat secure area that is not normally viewed by most people. Many sizes and types are available to fit almost any application. Choosing the proper size panel for the installation is an essential component of a security system. Too many zones and the system is overly complicated; too few zones could mean a weak system.



2GIG GC2 Security & Home Automation System

2GIG-CP21-345E	GO! Control 2 Panel touchscreen with 2-way voice, wireless receiver, Z-Wave transceiver, battery backup, <u>purchase cell module separately</u>	159.87
2GIG-CP21-345E2	Same as above, adds AC2 plug for transformer to avoid hard-wiring	161.12
2GIG-CPX1-345E	Non-branded version of above	158.62
2GIG-FP6-20PK	Blank name plates, for above, to print with your own logo, pack of 20	74.93
2GIG-CP-DESK	Desk/Table stand for the Go! Touchscreen	8.74

- Color Touchscreen Display
- Fully Self-Contained • Snap-in GSM Radio
- Updated Z-Wave Home Control
- Remotely Control Panel Settings
- Two-way Voice Over Cellular
- Over-the-air Update Functionality
- Customer Messaging Capable
- 60 Wireless Zones • 2 Hardwire Zones
- 24-hour Backup Battery • 32 User Codes

2GIG GC2 Controller Kits - Purchase Cellular Interface Separately

2GIG-GCKIT311	(1) 2GIG-CP21-345E, (3) 2GIG-DW10, (1) 2GIG-PIR1, (1) 2GIG-KEY2	256.45
2GIG-GCKIT410	(1) 2GIG-CP21-345E, (4) 2GIG-DW10, (1) 2GIG-PIR1	266.80
2GIG-GCKIT30IMG	(1) 2GIG-CP21-345E, (3) 2GIG-DW10, (1) 2GIG-XCVR2-345, (1) 2GIG-IMAGE1	294.13

2GIG-GCKIT311

- Includes:
- (1) 2GIG-CP21-345E
 - (3) 2GIG-DW10
 - (1) 2GIG-PIR1
 - (1) 2GIG-KEY2

Requires:
Cellular or IP communicator



Cellular Interfaces for 2GIG GC2

2GIG-GC3GAX-A	Alarm.com AT&T GSM 3G Module-GC2	89.93
2GIG-GCCDMVX-A	Alarm.com Verizon CDMA Module-GC2	89.93
2GIG-LTEV-A-GC2	Alarm.com Verizon 4G LTE Module-GC2	123.65
2GIG-GCCDMVX-NE	SecureNet Cellular GSM 3G Module-GC2	89.93
2GIG-GC3GUP-U	Uplink Cellular Radio Card-GC2	89.93



IP Communicator for 2GIG GC2

2GIG-BRDG1-900	Go!Bridge IP Communicator, requires 2GIG-XCVR2-345	67.45
----------------	----------------------------------------------------	-------



2GIG-BRDG1-900



2GIG-TS1-E



2GIG-CAM-HD100

Firmware Updates for 2GIG GC2

2GIG-UPCBL2	Firmware update cable for the TS1 and Go!	23.12
2GIG-UPDV	Easy Updater for GC2 panels, no PC required	68.68

TS-1 Wireless Touchscreen for 2GIG GC2

2GIG-TS1-E	2-way Wireless Touchscreen	118.66
2GIG-TS1-DESK	Desk/Table stand for the TS-1 Touchscreen	8.11
2GIG-XCVR2-345	900 MHz Transceiver, one per GoController for use with the 2GIG-TS1, 2GIG-IMAGE1, and 2GIG-BRIDG1-900	14.36

Image Sensor

2GIG-IMAGE1	Wireless Motion Detector Image Sensor, requires 2GIG-XCVR2-345 GC2 only	93.69
-------------	-------------------------------------------------------------------------	-------



- Pet immune wireless motion detector with color camera
- IR illuminated black and white night vision
- Send e-mails or MMS alerts with images attached
- Requires Firmware 1.10 or higher
- Requires a XCVR2 900MHz transceiver
- Requires an Alarm.com account with an Image Sensor Plan

2GIG Network Camera

2GIG-CAM-HD100	HD Indoor IP Camera with IR	134.90
----------------	-----------------------------	--------

2GIG Accessories



Looking to sell 2GIG from your iPhone or iPad?

- On your Apple device browse to 2GIG.com
- Under Dealer Materials, choose Dealer Site
- You will need a login. If you do not have one, apply for one.
- In the Dealer Site, on the left, look under Marketing for "Go! Control Demo App"
- Follow the instructions for loading the app

2GIG-GC-POTS	POTS Module for the 2GIG-CP21-345E, second generation Go! Controller	11.24
2GIG-ANT2X	Optional External GSM Attic Antenna, 10 ft	28.73
2GIG-ANT3X	Replacement External In-wall Antenna	7.48
2GIG-AC1	Replacement plug-in power supply	11.22
2GIG-BATT2X	Optional Extended Battery Pack, 24hr	21.21

Nothing sells better than a live demonstration. Show the customer how the system works. Add light control and lock control for a more effective demonstration.



2GIG-DEMOKIT	Includes CNTRL2, TSTAT, KEY2 and a DW10	299.00
--------------	-----------------------------------------	--------

Recommended Additions for a GREAT 2GIG demo

2GIG-GCCDMVX-A	Verizon CDMA Module w/ ANT3X antenna	89.93
2GIG-CAM-HD100	HD Indoor IP Camera with IR	134.90
2GIG-PD300EMZ51	Lamp Module, 300W Incandescent	32.19
BD99100-005	Standard Z-wave Deadbolt - Satin Nickel	137.39

Wireless Devices for GC2 and GC3

2GIG-DW10	Thin Door/Window Contact with external input	11.85
2GIG-DW20R	Recessed Door Contact	14.35
2GIG-DW40	Ultra-Compact D/W Sensor with bypass	14.35
2GIG-GB1	Glass Break Detector	46.21
2GIG-KEY2	4-Button Key Ring Remote	13.11
2GIG-TILT1-345	2GIG 345 MHz Tilt Sensor	23.09
2GIG-DBELL1-345	Wireless Doorbell	26.85
2GIG-PAD1	Wireless Keypad	37.48
2GIG-F1-345	Fall Detector Pendant	43.76
2GIG-PHB2-345	Personal Help Button Pendant	31.69
2GIG-PHB1-345	Personal Help Button Pendant-Wristband	31.69
2GIG-PANIC1	Panic Button Remote	23.73
2GIG-PIR1	Passive Infrared Motion Detector	36.21
2GIG-SMKT3	Smoke, Heat, and Freeze Detector	56.19
2GIG-SDS1-345	Smoke Ring Detector and transmitter	32.19
2GIG-FF-345	Smoke Detector Takeover Module	36.25
2GIG-CO3	Wireless Carbon Monoxide Detector	73.68
2GIG-FT1-345	Flood and Temp Sensor	38.08
2GIG-TAKE	8-Channel takeover transmitter. Converts 8 hard-wired loops to 2GIG wireless zones.	47.47
2GIG-TAKE-KIT1	Includes 2GIG-TAKE Module, a UL-rated plastic enclosure, and a 12/24VDC Power Supply Board with backup battery charging circuit. Will allow you to add up to two (2) additional Super Switch Takeover Modules.	80.56



GoControl®

Z-Wave Sensors and Controls

2GIG-LB60Z-1	Z-Wave Dimmable LED Light Bulb	29.50
2GIG-LB65R6Z-1	Recessed Lighting Retrofit Kit with LED Bulb	32.20
2GIG-LBR30Z-1	LED 65-watt Equiv. Indoor Flood Light Bulb	29.51
2GIG-PD300EMZ51	Plug-in Lamp Module, 300W, dimmable	32.19
2GIG-PS15EMZ5-1	Plug-in Appliance Module, 15A, relay	32.19
2GIG-WD500Z5-1	Decorator 500W Dimmer with neutral	32.19
2GIG-WS15Z5-1	Decorator Switch, 15A with neutral	32.19
2GIG-WT00Z5-1	Virtual 3-Way Accessory switch	32.19
2GIG-GC-TBZ48	Battery-Powered Z-Wave Thermostat 2H/2C or Heatpump 3H/2C	78.06

2GIG-WA00Z-1	Wall Switch Battery-Power Scene Controller	32.20
2GIG-WO15EMZ5-1	Wall Outlet, 15A, one side controlled	40.24
2GIG-WA105DBZ-1	Z-Wave 105 dB Siren	40.28
2GIG-WF00Z-1	Z-Wave Water Sensor with Ant - AC pwr	26.82
2GIG-WL00Z-1	Z-Wave Pipe-mount Water Flow Detector	74.65
2GIG-WDKIT-*	Color Change for WD500Z-1 and WD1000Z-1	3.48
2GIG-WTWSKIT-*	Color Change for WS15Z-1, WS15Z5-1, WT00Z-1 and WT00Z5-1	3.48

* = AL-Almond, BL-Black, and BR-Brown paddles.



Note: Z-Wave sensors are best for Automation. Use the 345 MHz sensors in the upper section for notifying Alarm.com or central station.



2GIG-KIT311-GC3

- 7" capacitive touchscreen
- 100 Wireless Zones · 2 Wired Zones
- 32 Keyfobs · 4 Keypads · 100 Users
- External siren output · 2 Open Collector Outputs
- 5-day weather forecast
- Arm button on home screen
- User-replaceable cell radio, no tools to install
- 3G AT&T, CDMA Verizon, or Rogers Network

The Image sensor and transceiver for the GC3 is not compatible with the GC2

The GC3 is the next level of all-in-one 2GIG controller. With a 7" color, capacitive touchscreen and an upgraded user-interface, homeowners will love how much faster and easier it is to use. Dealers will appreciate how much time they'll save during installation. Improvements include single-screen zone programming, elimination of redundant steps, one-touch arming, and easy-to-see status. These features, along with many others, make the GC3 customer experience the most intuitive of any security control system in the industry. Period.

Smart Home Control has been at the heart of all 2GIG panels since the very beginning. The new 2GIG GC3 makes working with smart home devices simpler than ever before. Programming new smart home devices is a snap with clear, step-by-step menus. The security and automation chips have been built with a modular design, allowing for incorporation of other emerging solutions to stay current in the ever-changing world of technology.

2GIG-GC3-345	GC3 Panel touchscreen with 2-way voice, wireless receiver, Z-Wave transceiver, battery backup, <u>purchase radio separately</u>	249.80
2GIG-KIT311-GC3	GC3 Panel, (3) 2GIG-DW10, (1) 2GIG-PIR1, (1) 2GIG-KEY2	330.98
2GIG-GC3GAX-A	GC3 AT&T GSM 3G cell radio	89.93
2GIG-LTEV-A-GC3	GC3 Verizon LTE cell radio	123.65
2GIG-IMAGE2	Image Sensor for GC3, requires transceiver	93.69
2GIG-XCVR3-GC3	Transceiver for GC3 Panels with Image sensor	18.80
2GIG-GC3-DEMOKI	Demo kit in plastic travel case with GC3 panel GC-TBZ48 GoControl Thermostat 2GIG-KEY2-345 Keyfob 2GIG-DW10-345 Wireless Sensor	623.25



Hybrid Controller

A Hybrid panel that is modular and customizable.

Vario security systems allow you to buy only what you need to get the job done. The equipment and offered services provide you proper coverage at the right price. Vario allows you to set up multiple security areas, with different settings, off one panel. Therefore, whether you need to protect family or inventory, Vario can adapt to get it done. In our modern and ever-changing world, security should never be rigid.

2GIG-V-KIT1	2GIG Vario LCD Keypad Kit Includes 2GIG Vario Main Board, 2GIG Vario Panel Enclosure, 2GIG Vario Wireless Receiver, 2GIG Vario LCD Icon Keypad w/ Prox, and 2GIG Vario Plug-In Power Supply	197.18
2GIG-V-KIT2	2GIG Vario LCD Keypad Kit Includes 2GIG Vario Main Board, 2GIG Vario Panel Enclosure, 2GIG Vario Wireless Receiver, 2GIG Vario Elegant Keypad w/ Prox, and 2GIG Vario Plug-In Power Supply	263.86
2GIG-V-KEYPROX*	2GIG Vario Elegant Keypad with Prox (Wht-White, Blk-Black	161.12
2GIG-V-LCDPROX	2GIG Vario LCD Icon Keypad with Prox	92.38
2GIG-V-BRD	2GIG Vario Main Board	73.84
2GIG-V-ZE8	2GIG Vario Zone Expansion Board	57.47
2GIG-V-8OUT	2GIG Vario 8 Voltage Output Expander	77.88
2GIG-V-4ROUT	2GIG Vario 4 Relay Output Expander	81.63
2GIG-V-PS3A	2GIG Vario Switching Power Supply	96.67
2GIG-V-VOICEMOD	2GIG Vario Digital Voice Module	61.76
2GIG-V-MICSPK	2GIG Vario Microphone / Speaker Module	52.63
2GIG-V-RECU	2GIG Only Vario Wireless Receiver	72.50
2GIG-V-RECH	2GIG and Honeywell Wireless Receiver	99.36
2GIG-V-BOX	2GIG Vario Panel Enclosure	19.87
2GIG-V-ACCBOX	2GIG Vario Accessory Enclosure	28.46
2GIG-V-AC5	2GIG Vario Plug-In Power Supply	17.19
2GIG-V-PSUSA	2GIG Vario Power Supply for Structured Wiring Cabinets	22.56
2GIG-V-RS232	2GIG Vario RS232 Update/ Connectivity Cable	40.82



2GIG-V-KIT1



2GIG-V-KIT2



2GIG-V-KEYPROXB



2GIG-V-LCDPROX



**2GIG-V-RECU
2GIG-V-RECH**



2GIG-V-MICSPK

Cellular Modules have not been released at time of printing, call for updated parts list

Alarm.com Products



ALAADC-VDB101



ALAADC-VDB102



ALAADC-T2000

HVAC

ALAADC-T2000	Smart Thermostat, White	89.93
ALAADC-S2000TRA	Remote Temperature Sensor for T2000	18.74

DoorBell Cameras

ALAADC-VDB101	Wifi Doorbell Camera (Satin Nickel)	148.63
ALAADC-VDB102	Wifi Doorbell Camera (Bronze)	148.63
ALAADC-VDB105	Slim Doorbell camera (Satin Nickel)	123.65
ALAADC-VDB106	Slim Doorbell camera (Bronze)	123.65

Home Health

ALAADCBOSBC23HW	Bed Sensor System w/ 2GIG xmitter	124.90
-----------------	-----------------------------------	--------

Network Cameras

ALAADC-V522IR	Indoor Wireless IR IP Camera with PS	98.67
ALAADC-V722W	Outdoor Wireless IR IP Camera with PS	142.39
ALAADC-VC726	POE Mini Bullet Camera with 4mm lens	92.43
ALAADC-VC826	POE Dome Camera with 2.8mm lens	92.43
ALAADC-VS121	Analog-to-IP Video Server	89.93
ALAADC-POE	POE Injector for the ALAADC-V720	43.72
ALAADC-SVR100	ADC Stream Video Recorder (1TB)	286.02
ALAADC-SVR1002	ADC Stream Video Recorder (2TB)	373.45

Alarm.com cameras require the Alarm.com service



ALAADC-VC826



ALAADC-V722W



ALAADC-V522-IR

Wireless Takeovers Have Never Been Easier



2GIG offers a great line of competitively priced wireless sensors; however, if the wireless is not 2GIG or Honeywell 5800 series look to Resolution Products. The translator products allow DSC, GE or Napco wireless products to work with 2GIG.

RESRE524X	Translator and Repeater, RF to RF 2GIG, Honeywell, Interlogix and Napco support	71.19
RESRE508X	Hardwire to 2GIG, Honeywell, Interlogix or Napco	71.19

2GIG is compatible with Honeywell 5800 series wireless without a translator

Z-Wave Large Load Control

ELK9200	30 Amp double pole relay with 110VAC coil in an enclosure. Plug into an appliance module for control of 110/220 VAC high current loads.	60.53
---------	-----------------------------------------------------------------------------------------------------------------------------------------	-------



- Pre-Wired Terminal Lugs for Easy Installation
- Ideal for Water Heaters, Motors, Pumps, etc
- Heavy Duty "Lockable" Metal Enclosure

alula Sensors for 2GIG



alula products also makes wireless sensors that are compatible with 2GIG. This includes sensors that are not available in the 2GIG line. There are also alternative transmitters that may meet your design needs better.

RESRE200RW	Keyfob	16.24
RESRE201T	Door/Window sensor, with hardwire inputs	16.24
RESRE203	Panic, water resistant	18.74
RESRE205	Below 40° or above 100° Temp Sensor	24.98
RESRE206	Tilt Sensor, great for garage doors	18.74
RESRE209	Glass Break	59.95
RESRE210T	PIR, Pet immune to 60 lbs	39.97
RESRE213T	Wireless Carbon Monoxide Detector	59.95
RESRE214T	Wireless Photoelectric Smoke	53.71
RESRE218T	2GIG Trident Leak and Temp Sensor	31.22
RESRE219	Home Disaster (Flood/Hi-Lo Temp) Sensor	41.22
RESRE222T	NanoMax (super tiny d/w sensor)	17.49
RESRE252T	Wireless Pinpad for 2GIG Controllers	23.73
RESRE116-U	Wireless Sounder with Transmitter	79.94
RESRE116	Wireless Sounder Receiver Only (add additional sounders to the transmitter)	67.45



RESRE205



RESRE252T



RESRE214T

Concealed Wireless Ion Security Sensors

Recessed plunger or magnetic contacts for doors and windows

IONMICRA-2G	2GIG compatible wireless window sensor: less than 1/2" deep x 3/4" wide	24.98
IONPLUNGER-2G	2GIG compatible wireless door sensor: less than 1" deep x 3/4" wide	24.98
IONFDB75	3/4" Forstner drill bit for Ion Sensors	6.24



Ion Micra



Installation Tip

For maximum range, keep the antenna straight using the provided plastic tube.



Ion Plunger

Utilize the Existing AC smokes

Monitoring AC-powered smokes with a security system has always been a challenge. There is no UL or NEC approved way to tie AC smokes into a low voltage system. Now, using wireless transmitters, we have options we didn't have before. Now you can transmit to a central station without affecting the UL protection of the smokes. FireFighter monitors the existing UL smoke detectors and when an alarm is detected a wireless signal is sent to the control panel. The 2GIG SmokeRing mounts like an extra base to the smoke and ties into the interconnect wire.

2GIG-FF-345	Firefighter Smoke Detector sensor (New)	36.25
2GIG-SDS1-345	Smoke Ring Detector and transmitter	32.20

PowerSeries Neo Control Kits

As the most comprehensive hybrid system available in the market today, PowerSeries Neo offers flexible scalability and a number of expansion opportunities. A variety of control panels, a wide range of compatible PowerG- enabled wireless devices and a complete line of expansion modules protect the investment and ensure growth in the future.

The power behind PowerSeries Neo lies in various innovative technologies, including the revolutionary PowerG, which, bundled together, provide a robust and feature-rich platform. Designed to reduce operational costs for dealers and provide ultimate reliability for end users.



Full Message Keypad

DSCHS32119CP01	Contains one HS2032NK in a large cabinet, HS2LCDRF9ENG full message hardwired keypad with built-in PowerG transceiver, battery, transformer, and interior siren	233.14
DSCHS3251CP01	Contains one HS2032NK in a large cabinet, HS2LCD9ENG full message hardwired keypad, battery, transformer, and interior siren	165.44
DSCHS2016NKCP01	Neo HS2016 Control panel in a large cabinet. 6 zones expandable to 16.	52.90
DSCHS2032NKCP01	Neo HS2032 Control panel in a large cabinet. 8 zones, expandable to 32.	68.53
DSCHS2064NKCP01	Neo HS2064 Control panel in a large cabinet. 8 zones, expandable to 64.	89.03
DSCHS2128NKCP01	Neo HS2128 Control panel in a large cabinet. 8 zones, expandable to 128.	226.81

PowerSeries Neo Keypads

DSCHS2TCHP*	PowerSeries Neo 7" TouchScreen (White or Black)	220.15
DSCHS2LCDENG	Full Message Hardwired Keypad (no receiver)	108.46
DSCHS2LCDRF9ENG	Full Message Hardwired Keypad with Built-in PowerG Transceiver	134.38
DSCHS2ICNENG	ICON Hardwired Keypad	56.92
DSCHS2ICNRF9ENG	ICON Hardwired Keypad with Built-in PowerG Transceiver	78.09
DSCHS2LCDWF9ENG	Wireless Full Message LCD Keypad	123.83
DSCHS2LCDWFPV9	Wireless Full Message LCD Keypad with Prox Support and Voice Prompt	175.81

All Keypads are available with a Prox tag reader. Please call for more info.



DSCHS2TCHPWHT

Neo PowerSeries Keypads and Touchscreens cannot be used on Standard PowerSeries

PowerSeries Neo Modules

DSCHSM2HOST9	PowerG Host Transceiver Module	87.50	DSCCD8080VZ	CDMA Alarm.com w/o Image Sensor	229.32
DSCPG9920	Wireless PowerG Repeater	104.45	DSCCD8080IVZ	CDMA Alarm.com supports Image Sensor	252.25
DSCHSM2108	Neo 8-Hardwired Zone Expander Module	31.97	DSC3G8080AT	AT&T Alarm.com w/o Image Sensor	229.32
DSCHSM2300	Neo Power Supply Module	56.52	DSC3G8080IAT	AT&T Alarm.com supports Image Sensor	252.25
DSCHSM2208	Neo 8 Output Module	34.50	DSC3G2080REUSA	C24 HSPA Cellular Alarm Communicator	194.92
DSCHSM2204	Neo High Current 4 Output Module	67.76	DSCCTL2803GREUSA	Dual Path IP and C24 HSPA Communicator	245.37
			DSCCTL280RE	Internet Alarm Communicator (3rd party)	118.48
			DSCPCL422	Communicator Remote Mounting Module	26.75

Neo and Standard PowerSeries modules are not interchangeable.

PowerG Wireless (Only for Neo panel with PowerG transceivers)

DSCPG9938	Wireless PowerG Panic Key	38.84	DSCPG9985	Wireless PowerG Flood Detector	50.70
DSCPG9949	Wireless PowerG 2-button Key	26.13	DSCPG9984P	Wireless PowerG Dual Tech Motion	77.20
DSCPG9939	Wireless PowerG 4-button Key	29.79	DSCPG9994	Wireless PowerG Outdoor PIR Detector	185.29
DSCPG9929	Wireless PowerG In-line 4-button Key	38.58	DSCPG9922	Wireless PowerG Glass Break Detector	84.08
DSCPG9975	Wireless PowerG Vanish Door/Window	31.04	DSCPG9926	Wireless PowerG Smoke Detector	77.95
DSCPG9945	Wireless PowerG Door/Window with Input	29.35	DSCPG9916	Wireless PowerG Smoke & Heat Detector	73.85
DSCPG9914	PowerG PIR Motion Detector, 85lb Pet Immune	65.88	DSCPG9913	Wireless PowerG CO Detector	81.12
DSCPG9924	Wireless PowerG Curtain PIR Detector	50.96	DSCPG9905	Wireless PowerG Temperature Detector	50.96
DSCPG9911B	Wireless PowerG Outdoor Siren	123.29	DSCPG9901BATT	Wireless PowerG Indoor Siren	78.96

Wireless Range is estimated to be 1.25 miles open air

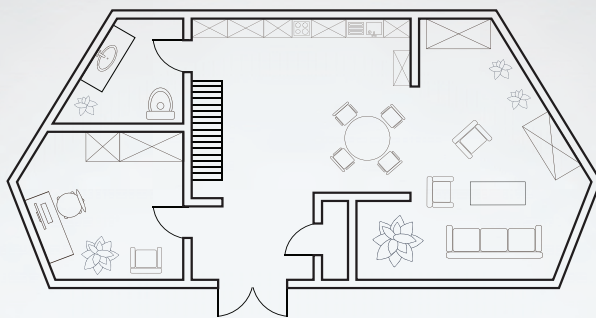

All the home security
and automation you need,
under one roof.



The new iotega Wireless Security & Home Automation solution. iotega can be summed up in three words: Secure, Simple and Scalable.

Secure. Fully encrypted and wireless security backed by PowerG technology.

Simple. Easy installation and ability to manage systems remotely.

Scalable. Start with basic security to a fully secured smart solution with the ability to connect to home automation devices.

iotega[®]

with
PowerG
Technology

DSC

Visit DSC.com/iotega to learn more.

DSC Iotega

We are excited to introduce DSC's next generation wireless security and automation platform - Iotega! Iotega is the most advanced security and home automation platform on the market today. You can now offer a simple to install solution that includes encrypted security sensors, Z-Wave for home and business automation, built in Ethernet and Wi-Fi for easy installation, and it can connect up to 8 cameras for local and remote viewing. We think you will agree that there isn't anything like this available on the market today.

You can provide your customers with the security they already know and trust, along with the freedom to choose from a variety of home automation devices powered by SecureNet. Iotega is based on built-in PowerG wireless technology and is a fully encrypted security system which will help generate revenue by providing your customers the flexibility to start with a security only package and scalability to upgrade to a full security and home automation solution. No other security solution offers better peace of mind as users can remotely monitor their home or business, regardless of how tech savvy they are. You will save time and money with Iotega as installations are made simple with the latest innovations in wireless networking technology.



Iotega Uses PowerG transmitters shown on Page XXX

DSCWS900-91HATS	Iotega 3-1 Kit, AT&T, kit includes (3) PG9975 and (1) PG9914P	351.62
DSCWS900-91LVZS	Iotega 3-1 Kit, Verizon, kit includes (3) PG9975 and (1) PG9914P	405.13
DSCWS900-91S	Iotega 3-1 Kit . no cell, kit includes (3) PG9975 and (1) PG9914P	291.99
DSCWS9009S	Iotega Security panel, Wi-Fi and Ethernet, no cell	200.26
DSCWS9009HATS	Iotega Security panel, Wi-Fi and Ethernet, AT&T cell	259.89
DSCWS9009LVZS	Iotega Security panel, Wi-Fi and Ethernet, Verizon cell	313.40

Securenet provides service for cellular and automation app control.

IOTEGA initial release will be 40 zones, expanded to 128 zones via firmware upgrade.

DSC Impassa with Alarm.com

DSCKIT45799AAT	Alarm.com 311 kit with (1) WS4904P wireless pet immune motion detector, (1) WT4939 wireless keyfob, (3) WS4945 wireless door/window contacts. Xfrmer and Batt, AT&T communicator.	458.63
DSCKIT45799AVZ	Alarm.com 311 kit with (1) WS4904P wireless pet immune motion detector, (1) WT4939 wireless keyfob, (3) WS4945 wireless door/window contacts, Xfrmer and Batt, Verizon communicator.	458.63

The above controls and kits will not support the Alarm.com Image Sensor. If you ever intend to add an Image sensor, order kits below.



Impassa Alarm.com Kits with Image Sensor Support

DSCKIT45799AIAT	Same as DSCKIT457-99AAT with the addition of an Alarm.com image sensor	626.80
DSCKIT45799AIVZ	Same as DSCKIT45799AVZ with the addition of an Alarm.com image sensor	626.80

Impassa Products with TelGuard Home Control



All kits include control/keypad, manuals, battery, RJ31X, and transformer		
DSCKIT45792	Impassa 92 3G-ready kit with (1) WS4904P wireless pet immune motion detector, (1) WT4939 wireless keyfob, (3) WS4955 wireless door/window contacts	298.11
DSCKIT457-96H	Impassa 96H with integrated C24 HSPA (3G) communicator kit with (1) WS4904P wireless pet immune motion detector, (1) WT4939 wireless keyfob, (3) EVDW4975 vanishing contacts	420.41
DSCKIT457-99H	Impassa 99H with integrated C24 HSPA (3G) communicator kit with (1) WS4904P wireless pet immune motion detector, (1) WT4939 wireless keyfob, (3) WS4945 door/window contacts	420.41
DSCSCW9057DMK	Desk stand for Impassa control	16.05

Two-Way Wireless Devices

These devices are only supported by the DSC two-way Impassa and Powerseries 4.6 controls

DSCWT5500	Wire-free keypad	125.07
DSCWT5500D	Wire-free keypad with stand & transformer	142.05
DSCWT5500P	Wire-free keypad with proximity reader	148.23
DSCWT5500X	Transformer for WT5500 keypad	10.19
DSCWTK5504	Wire-free touchscreen	154.40
DSCWTK5504D	Wire-free touchscreen with stand	162.13
DSCWT4989	2-way wireless keyfob w/ icon display	41.69
DSCWT4901	Wireless indoor siren	55.58
DSCWT4911B	Wireless outdoor siren, blue lens	115.81
DSCWT4911R	Wireless outdoor siren, red lens	115.81



DSCWTK5504 DSCWT4901 DSCWT4989 DSCWT5500

Standard one-way wireless devices are listed on page 120

Hardwired Photoelectric Smoke Detectors



FSA Series Smokes

TECHNICAL NOTE:

The proper installation of a 4-wire smoke detector system includes an end-of-line relay to supervise the power lines of the smokes. If you use smokes with sounders, you also need a polarity-reversing relay to cause all sounders to trigger when the alarm occurs.

DSCFSA210B	2-wire, basic smoke	29.26
DSCFSA210BT	2-wire with heat sensor	30.09
DSCFSA210BST	2-wire w/ heat sensor and 85 dB sounder	26.95
DSCFSA410B	4-wire, basic smoke	30.80
DSCFSA410BT	4-wire with heat sensor	30.80
DSCFSA410BS	4-wire with 85 dB sounder	33.90
DSCFSA410BST	4-wire w/ heat sensor and 85 dB sounder	26.95

Fire Alarm Necessities

DSCPRM2W	Polarity reversal module, for use with 2-wire smoke detectors, will convert 2-wire smokes to 4-wire, need 1 per zone	23.62
DSCPRM2WC	Polarity reversal module, same as above, in plastic case	28.83
DSCPRM4W	Polarity reversal module, for use with 4-wire smoke detectors	19.68
DSCPRM4WC	Polarity reversal module, same as above, in plastic case	28.83
DSCRM2	EOL power supervisory relay, 4-wire smoke circuit supervision	15.29



DSCPRM4W

DSC Motion Detectors and Glassbreaks

DSCLC120PI	Digital PIR detector with 55 lb. pet immunity	22.13
DSCBV500	Ceiling-mount 360 degree PIR	27.85
DSCBV501GB	Ceiling-mount 360 degree PIR with built-in glassbreak	46.06
DSCBV600	Dual-element, pet-immune PIR	25.87
DSCLC100PI6P	Quad linear technology, pet-immune	8.78
DSCLC103PIMSK	Dual tech, PIR/microwave, pet-immune 55 lb, anti-masking	59.19
DSCLC104PIMWW	Dual tech, PIR/microwave, pet-immune 55 lb, quad linear technology	44.78
DSCLC151	Outdoor dual tech PIR/microwave with adjustable pet immunity	77.20
DSCLC171	Outdoor dual tech double PIR/microwave with adjustable pet immunity	120.44
DSCAC100	Wall-mount, up to 25', jumper-selected sensitivity	27.02
DSCAC500	Ceiling-mount, up to 25' away	35.51
DSCAFT100	Glassbreak simulator; the accurate way to test your glassbreaks	101.06



Sirens

DSCSD15W	15W Dual Tone Surface Mount Siren, 12VDC	3.82
DSCSD30W	30W Dual Tone Surface Mount Siren, 12VDC	7.64











PowerSeries Wireless Receivers

DSCTR5164433	Wireless two-way receiver for PowerSeries control, supports 64 wireless zones and 16 wireless keys, ver 4.6 or later	88.29
DSCRF5132-433	Wireless receiver for PowerSeries control, supports 32 wireless zones and 16 wireless keys	59.10
DSCPC5320	Connect up to 4 wireless receivers for increased coverage, for PowerSeries	60.20
DSCRXL2433	Universal wireless relay module, 2 on-board relays, can be independent of security system for access and light control	43.23

DSC PowerSeries panels with firmware of 4.6, and with the DSCTR5164433 receiver, can now support wire-free keypads and other 2-way wireless devices (not sirens). See page XXX for 2-way devices.
If you need a wireless siren, please call Worthington technical support for assistance.

Wireless Devices for all Versions of DSC Controls

								
DSCWLS912L433	DSCWS4939	DSCEVDW4917	DSCEVDW4975	DSCWS4936	DSCWS4965	DSCWS4904P	DSCWS4985	
DSCWS4913	Wireless carbon monoxide detector	76.43	DSCWS4904P	Wireless PIR (85 lb pet-immune)	64.34	DSCWS4936	Wireless smoke/heat	60.79
DSCWS4904P	Wireless PIR (85 lb pet-immune)	64.34	DSCWS4965	Tri-Zone wireless door/window contact	35.43	DSCWLS912L433	Wireless glassbreak	67.12
DSCWS4965	Tri-Zone wireless door/window contact	35.43	DSCEVDW4917	Wireless recessed door transmitter	39.37	DSCEVDW4927SS	Wireless shock sensor with contact	44.71
DSCEVDW4917	Wireless recessed door transmitter	39.37	DSCEVDW4975	Vanishing wireless door contact	26.50	DSCWS4938	1-button personal panic	30.19
DSCEVDW4975	Vanishing wireless door contact	26.50	DSCWS4945	Wireless door/window contact N/C	31.81	DSCWS4949	2-button wireless keyfob	23.62
DSCWS4945	Wireless door/window contact N/C	31.81	DSCWS4945N	Wireless door/window contact N/O	26.38	DSCWS4939	4-button wireless keyfob	26.05
DSCWS4945N	Wireless door/window contact N/O	26.38	DSCWS4985	Wireless flood detector	46.33			
DSCWS4985	Wireless flood detector	46.33						

PowerSeries Residential Control Kits

Today's PowerSeries product family not only protects people, premises and possessions, but also provides unprecedented levels of convenience, comfort and control. DSC makes it easy for you to stay ahead of the technology curve with the easiest to sell, easiest to install and easiest to use security systems anywhere. There are 3 basic sizes available: 6 to 16 zone, 8 to 32 zone, and 8 to 64 zone capability. 16.5 Volt transformer sold separately.



DSKIT3251NT

All kits below are in enclosure and include battery, RJ31X, and indoor siren. Transformer is sold separately.

DSKIT3251NT	PC1832NK panel in enclosure, PK5500 full-message keypad	206.11
DSKIT32POWER5N	PC1832NK panel in enclosure, PK5501 picture icon keypad, LC100PI motion	146.79
DSKIT32-16CP01	PC1832 panel in enclosure, RFK5501 keypad with wireless receiver, LC100PI motion	149.95
DSKIT32219NT	PC1832 panel in enclosure, RFK5500 keypad with wireless receiver, LC100PI motion	196.31
DSCPC1864NK	PC1864 panel in enclosure	89.09
ELKTRG1640	16.5V 40VA transformer with ground and reset	10.40

PowerSeries Keypads



DSCPK5500

DSCPK5500	64-zone LCD full message keypad, input/output terminal, FAP keys, full 32-character phrases	98.02
DSCPK5501	64-zone LCD picture icon keypad, input/output terminal, Fire, Ambulance, Police keys	59.45
DSCRFK5500	Same as DSCPK5500, with integrated 32 zone RF receiver	146.07
DSCRFK5501	Same as DSCPK5501, with integrated 32 zone RF receiver	82.63
DSCRFK5564	Same as DSCPK5500, with integrated 64 zone RF receiver for PC1864 V4.6 or later	146.07



DSCPTK5507

PowerSeries Touchscreen Security Interface
7" full color display, 800x480 resolution, slim modern design, intuitive LED indication of security system status, picture frame feature, clock feature, intuitive user interface, customizable home screen, customizable wallpaper, menu user programming, installer programming, virtual keypad, SD card, photos, compatible with PC1864, PC1832, PC1616 control panels, approvals: IC, FCC.

DSCPTK5507*	7" LCD Touchscreen for PowerSeries controls, customizable and intuitive (*White or S-Silver)	231.15
DSCWTK5504	2-way Wireless 4.3" Touchscreen Arming Station	154.40

PowerSeries Modules

DSCPC5108	8-hardwire zone expander; adds 8 zones and 125 mA aux power	30.89
DSCPC5100	Addressable zone expander; adds up to 32 addressable devices	36.92
DSCPC5200	Power supply module; 1 Amp	58.20
DSCPC5204	Power supply module; adds 4 programmable high-current outlets, rated at 1 Amp	72.94
DSCPC5208	Output module; adds 8 programmable low-current outputs	36.12
DSCESCORT5580TC	Telephone Interface, turns any touch tone phone into a talking keypad	102.49
DSCIT100	Data interface module; supports bi-directional RS232 commands for third party interface	53.51
DSCIT230	RS-422 interface module for HomeControl Gateway and some third party systems	64.21



DSCADCSEM-110PSV



DSCTLINKTL250



DSCTL260R-NA



DSCPC5108

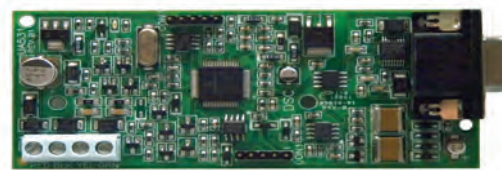

DSCIT100

DSCADCSEM110PSV	Alarm.com System Enhancement Module, Adds ADC services to Powerseries Panels- Verizon	CALL
DSCTLINKTL250	T-Link Internet Alarm Communicator; supports PowerSeries and Maxsys control panels, supports DHCP, download control panel programming over the internet, reports to 2 different IP addresses with Sur-Gard IP receiver	193.01
DSCTL260R-NA	T-Link Internet/Intranet Alarm Communicator; supports PowerSeries V4.1 or higher control panels, remote uploading and downloading, interface for C24 hub	108.09
DSC3G2060R-USA	HSPA (3G) Cellular Alarm Communicator for PowerSeries controls, supports PowerSeries V4.1 or higher control panels, remote uploading and downloading, interface for C24 hub	192.62
DSCTL2603GR-USA	Fully redundant Internet and HSPA dual-path alarm communicator, supports PowerSeries V4.1 or higher control panels, remote uploading and downloading, interface for C24 hub	236.24



DSCTL2603GR-USA

Hardwire Detectors for any Security System

Micro PIR

Some of the smallest PIRs in the industry. The Clip PIR is 2-3/4" tall and 1-1/4" wide. The Spy PIR recesses into a 7/8" hole and is 2-3/4" wide.

VISCLIP-1	Micro PIR, wide angle, 30' x 40'	32.25
VISCLIP-4N	Micro PIR, 12' solid curtain	32.25
VISSPY-1	Micro PIR, flush-mount, 35' long range	46.66
VISSPY-2	Micro PIR, flush-mount, 25' x 50°	46.66
VISSPY-4	Micro PIR, flush-mount, 12' solid curtain	46.66
VISSPY-RTE-B	Micro PIR, for access, contact output	47.30



VISDISC



VISCLIP-1



VISSPY-4

Motion Detectors

VISDISC	Small 360° ceiling-mount, 36' at 12' height	31.37
VISDUO240E	Small dual-tech PIR, digital, ceiling-mount	55.11
VISNEXTDUOK985	Dual tech, 80lb pet immune w/ TSI, 40'	38.36
VISMR-4000	Flush-mount in 1-gang box, 45' x 45'	45.98
VISK940-UL	Pet immune 40lb, 30' x 30'	12.79
VISNEXTK985	Pet Immune 85lb, 50' x 50'	19.71
VISDUO200E	Small digital dual PIR 40' x 40'	37.86



VISSPY-1



VISMR-4000



VISDL-125C

Specialty Devices

VISDA-5	Request-to-exit PIR detector	43.78
VISDL-125C	Voice dialer, 12VDC power supply not included	92.09
VISSPY-RTE-A	Micro PIR, flush-mount, 12' solid curtain request-to-exit	47.30

While the best solution for security monitoring is still a central station, many homeowners are requesting that their security systems call their cell phones, either as a primary or secondary notification. The DL-125C is an automatic programmable speech dialer with two alarm inputs designed for verbal reporting of two separate events.



Alternative Wireless Contacts

Ion Security was formed with the purpose of creating new, innovative wireless products for the residential and commercial security markets. The products below are examples of new styles of transmitters. They are compatible with the GE, 2GIG, Omni, and DSC wireless receivers and have an expected range of 500 feet. Please specify which receiver you are working with.

IONMICRA-HA	Omni compatible concealed wireless window sensor, 1/2" deep, 3/4" wide, low profile magnet	24.98
IONPLUNGER-HA	Omni compatible concealed wireless door sensor, 1" deep, 3/4" wide	24.98
IONMICRA-2G	2GIG compatible concealed wireless window sensor, 1/2" deep, 3/4" wide, low profile magnet	24.98
IONPLUNGER-2G	2GIG compatible concealed wireless door sensor, 1" deep, 3/4" wide	24.98
IONMICRA-G	GE/Qolsys compatible concealed wireless window sensor, 1/2" deep, 3/4" wide, low profile magnet	24.98
IONPLUNGER-G	GE/Qolsys compatible concealed wireless door sensor, 1" deep, 3/4" wide	24.98
IONMICRA-D	DSC compatible concealed wireless window sensor, 1/2" deep, 3/4" wide, low profile magnet	24.98
IONPLUNGER-D	DSC compatible concealed wireless door sensor, 1" deep, 3/4" wide	24.98
IONFDB75	3/4" Forstner drill bit for drilling perfect holes	6.24



IONMICRA-*



IONPLUNGER-*



Sirens and Low Current Sounders

Piezo Sirens

ATWSGST-W	Piezo siren, single-gang flush, indoor, 105dB, 20mA	8.74
ATWBULLDOG	Piezo siren, surface-mount, indoor/outdoor, 105dB, 110mA	8.99
ATWBLOODHOUND	Piezo siren, 1-gang box mount, indoor/outdoor, 104dB, 90mA	8.99
ATWDOBERMANPLUS	Piezo siren with strobe, surface-mount, outdoor, 104dB, 180mA	17.36
ATWPC-300	Multi-tone piezo chime, single-gang, flush, 3-tone, 80 dB	15.36

Sirens (built-in driver)

ATWDS-50	5" dual tone 15W siren	6.00
ATWDS-406	4" x 6" dual tone 25W siren	11.74
ATWDS-301SET	Siren in stainless steel enclosure with tampers, 25W	33.41

8 Ohm Siren Speakers (driver separate)

ATWFK-56	Flush-mount 15W speaker	6.87
ATWH-508	Speaker horn, 30W peak	11.49
ATWSTL-1*	Strobe for DS-301SET or H-301SET (*amber, blue, clear, red)	9.74



ATWBULLDOG



ATWSGST



ATWDOBERMANPLUS



ATWDS-406



TELTG1LAX01	TG-1 Express LTE-A, Primary Residential Alarm Communicator for AT&T LTE Network	138.64
TELTG1LX001	TG-1 Express Verizon, Primary Residential Alarm Communicator for Verizon Network	138.64
TELTG1LA001B	TG-1B LTE-A Primary and Back-up Residential Cellular Only Alarm Communicator	158.62



TG1 Express

TG-1 Express has been tested successfully on a Leviton Omni Controller.

Universal Alarm Transceivers



NAPSLECDMA-C	StarLink Connect™ Universal Dual Path communicator - Verizon	129.85
NAPSLECDMA-Z	StarLink Connect™ Universal Dual Path communicator with Z-Wave - Verizon	149.83
NAPSLECDMA	StarLink™ Up/Downloadable Verizon Universal Alarm Communicator	99.87
NAPSLEGSM34G	StarLink™ Up/Downloadable GSM 3G / 4G Universal Alarm Communicator	99.87
NAPSLEANTEXT	High quality remote antenna with 15 feet of high performance low-loss coaxial cable	68.15
NAPSLECDMAFIRE	Sole Path Fire Alarm Cellular Communicator (Red), Verizon	139.83
NAPSLEGSMFIRE	Sole Path Fire Alarm Cellular Communicator (Red), ATT GSM	139.83
NAPSLEANTEXT	High quality remote antenna, 15 ft Coax, bracket	68.15

Starlink CDMA has been tested successfully on a Leviton Omni Controller.



NAPSLECDMAFIRE

Universal Alarm Transceivers



DSCTL300	T-Link Universal IP Alarm Communicator; compatible with ANY alarm panel that uses Contact ID format	193.01
DSCTL300CF	Commercial Fire Approved T-Link Universal IP Alarm Communicator; compatible with ANY alarm panel that uses Contact ID format	397.33
DSC3G4000USA	HSPA Universal Cellular Alarm Communicator, works on ANY control panel using Contact ID via CONNECT24™	123.83
DSC3G4010USA	HSPA Universal Cellular Alarm Communicator, works on ANY control panel using Contact ID direct to any central station using Sur-Gard system	160.52
DSC3G4010CFUSA	Commercial Fire Approved HSPA Fire Alarm Communicator. Works on ANY fire panel using Contact ID direct to central station using Sur-Gard system. Approved for commercial fire applications.	305.76

Universal Alarm Transceivers



IPD-BAT-LTE	Universal Dual Path Verizon and IP communicator, keypad emulator for GE, Honeywell, and DSC	162.31
IPD-BAT-CDMA	Universal Dual Path Verizon and IP communicator, keypad emulator for GE, Honeywell, and DSC	149.82
IPDBATCDMAWIFI	Universal Dual Path Verizon and Wi-Fi communicator, keypad emulator for GE, Honeywell, and DSC	173.55
IPD-BAT-WIFI	Wi-Fi Broadband alarm transceiver - Compatible with DSC, GE, and Honeywell	102.42
IPD-BAT-CDMA	Hardwired Broadband alarm transceiver - keypad emulator for GE, Honeywell, and DSC	149.82
IPD-BAT-CU-ANT	CDMA Cellular Antenna	4.93



IPDatatel works with most alarm panels. Contact us on how to operate with the Leviton Omni Controller

Universal Cellular Booster



Wilson Electronics cell signal boosters are perfect for GSM installations with weak signal strength inside the home. The kit places an antenna outside to capture the signal and repeats the cell connection in the home. As an added benefit, it improves your customer's standard cell connections as well! This model will work with all US carriers. Installation is simple. Just mount the outdoor antenna and run coax from the antenna to the indoor unit, mounted central to the structure. No programming or configuration is necessary.

WIX470103	Connect 4G 5-band Amplifier Kit - Boosts 4G LTE & 3G signals for the entire home, up to 5000 sq ft	549.99
WIX471104	Connect 4G-X is the most powerful consumer signal booster sold, boosting 4G LTE and below for all North American carriers. 7500 sq ft	853.84

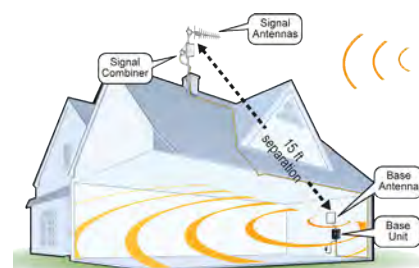

Wireless Security Devices

Interlogix/Qolsys Compatible

RESRE100	4-button Keyfob	14.36
RESRE101	Door/Window, also supports external	16.24
RESRE103	Panic, Wrist Band	18.74
RESRE105	Temp Range Sensor	24.98
RESRE106	Tilt Sensor, great for garage doors	18.74
RESRE109	GE Compatible Glass Break	59.95
RESRE110P	PIR, Pet Immune to 85lb, 40 ft range	49.96
RESRE113	Wireless CO Detector	59.95
RESRE114	Photoelectric Smoke	53.71
RESRE118	Trident Leak and Temp Sensor	31.22
RESRE119	Home Disaster Transmitter	41.22
RESRE122	NanoMax Door/Window, supports external	16.24
RESRE151	Hidden Panic	24.98
RESRE152	Pinpad Keyfob, Remote keypad	23.73
RESRE153	Outdoor PIR	77.44

2GIG/Honeywell Compatible

RESRE200RW	2GIG/Honeywell 5-button Keyfob	16.24
RESRE201	Honeywell Door/Window, supports external	16.24
RESRE201T	2GIG-only Door/Window, supports external	16.24
RESRE203	2GIG/Honeywell Panic, Wrist Band	18.74
RESRE205	2GIG/Honeywell Temp Range Sensor	24.98
RESRE206	2GIG/Honeywell Tilt Sensor	18.74
RESRE209	2GIG/Honeywell Compatible Glass Break	59.95
RESRE210P	2GIG/Honeywell PIR, Pet Immune to 85lb	49.96
RESRE214T	2GIG-only Compatible Photoelectric Smoke	53.71
RESRE213	Honeywell Compatible Carbon Monoxide	59.95
RESRE213T	2GIG-only Compatible Carbon Monoxide	59.95
RESRE214	Honeywell Compatible Smoke w/ Heat	53.71
RESRE214T	2GIG Compatible Smoke w/ Heat	53.71
RESRE218	Honeywell Trident Leak and Temp Sensor	31.22
RESRE218T	2GIG Trident Leak and Temp Sensor	31.22
RESRE219	Home Disaster Transmitter	41.22
RESRE222	Honeywell Compatible NanoMax	16.24
RESRE222T	2GIG-only Compatible NanoMax	17.49
RESRE251	2GIG/Honeywell Hidden Panic	24.98
RESRE252	Honeywell Compatible Pinpad	23.73
RESRE252T	2GIG-only Compatible Pinpad	23.73
RESRE253	Honeywell Compatible Outdoor PIR	77.44
RESRE253T	2GIG Compatible Outdoor PIR	77.44

DSC Compatible (433MHz)

RESRE300	4-button Keyfob	14.36
RESRE301	Door/Window	16.24
RESRE305	Temp Range Sensor	24.98
RESRE306	Tilt Sensor	18.74
RESRE309	DSC Compatible Glass Break	59.95
RESRE310P	PIR, Pet Immune to 85lb, 40 ft range	49.96
RESRE314	DSC Compatible Smoke w/ Heat	53.71
RESRE318	Trident Leak and Temp Sensor	31.22
RESRE319	Home Disaster Transmitter	41.22
RESRE322	DSC Compatible NanoMax	16.24
RESRE352	Pinpad Keyfob, Remote keypad	23.73
RESRE353	Outdoor PIR	xx.xx

alula offers an array of common usage and specialty wireless security devices. Most notable are their takeover translators. Now you can replace that "other guy's" control panel without needing to replace all the wireless devices in the house. They also carry repeaters and other devices compatible with major wireless security panels.

Takeover Translators

RESRE508X	Universal Hardwire Takeover Hardwire to 2GIG, Honeywell, Interlogix or Napco	71.19
RESRE524X	Universal Wireless Takeover/Repeater. Convert between 2GIG, Honeywell, Interlogix or Napco. Will also repeat same signal.	71.19



RESRE113
RESRE213
RESRE213T



RESRE114
RESRE214
RESRE214T
RESRE314



RESRE109
RESRE209
RESRE309



RESRE110P
RESRE210P
RESRE310P



RESRE103
RESRE203



RESRE118
RESRE218
RESRE218T
RESRE318



RESRE101
RESRE201
RESRE301



RESRE153
RESRE253
RESRE253T
RESRE353



RESRE122
RESRE222
RESRE222T
RESRE322



RESRE200-5



RESRE100
RESRE300



RESRE116-U

Universal Wireless Siren

RESRE116-U	Wireless Universal Siren with Transmitter	79.94
RESRE116	Wireless Siren only	67.45

The Connect+ is a modern, wireless security solution that will reduce installation time and is ready to scale your business from essential level installations such as renters to advanced level automation for home and business owners. As a dealer, you now have a solution that offers your customers a choice between a DIY or professional installation experience.

Connect+

Connect+ Kits		
RESREHXX-210	Connect+ Kit, (2) Nanomax (1) PIR	175.61
RESREHXX-210A	Connect+ Kit, (2) Nanomax (1) PIR (1) PINpad	198.15
RESREHXX210C	Connect+ Kit, (2) Nanomax (1) PIR (1) Touchscreen	264.60
RESREHXX-311A	Connect+ Kit, (3) Nanomax (1) PIR (1) PINpad	227.23
RESREHXX-311C	Connect+ Kit, (3) Nanomax (1) PIR (1) Touchscreen	293.68
Connect+ Panel		
RESRE6100S-XX-X	Connect+ Control Platform, 2-Way Voice GSM, SecureNet, No Cards	104.92
RESRE6100P-XX-X	Connect+ Control Platform, No Cards, SecureSmart specific branding	104.92
RESRE6100S-XX-X	Connect+ Control Platform, No cards, No Branding	104.92
Connect+ Panel Expansion Cards		
RESRE926RS	Communicator, WiFi, Connect+	62.45
RESRE927RSA	Communicator, 3G GSM, Connect+	109.91
RESRE929RCV	Communicator, LTE Verizon, Connect+, Clare Controls	99.92
RESRE929RPV	Communicator, LTE Verizon, Connect+, SecureSmart	99.92
RESRE929RSV	Communicator, LTE Verizon, Connect+, SecureNet	99.92
RESRE934Z	Wireless Card, Zwave, Connect+	28.73
RESRE934T	Wireless Card, Universal Translator, Connect+	51.21
RESRE934ZT	Wireless Card, Zwave & Translator combo, Connect+	68.70
Panel Accessories		
RESRE657W	Touchscreen without WiFi Expansion Card, White	83.68
RESRE657B	Touchscreen without WiFi Expansion Card, Black	83.68
RESRE657W-R	Touchscreen with Expansion Card, White	93.68
RESRE657B-R	Touchscreen with Expansion Card, Black	93.68
RESRE656	Bluetooth Capacitive Keypad	53.71
RESRE626	HeliRazor Siren	36.22
RESRE616	Additional HeliRazor Siren without transmitter	67.45
RESRE012-9	Optional Power Supply for HeliRazor	4.37
Translator and Repeater		
RESRE608	Hardwire to Cryptix™	56.20
RESRE620	Cryptix™ Repeater, Connect+	71.19



RESRE657W-R



RESRE6100S-XX-X



RESRE656



RESRE613



RESRE614



RESRE609



RESRE610P



RESRE603



RESRE618

Cryptix™ Compatible Sensors		
RESRE600	4-Button Keyfob	14.36
RESRE601	Door/Window, also supports external inputs	16.24
RESRE603	Panic Wrist Band	18.74
RESRE605	Temperature Range Sensor	24.98
RESRE606	Tilt Sensor, great for garage doors	18.74
RESRE609	Glass Break Detector	59.95
RESRE610P	PIR, Pet Immune to 85lb, 40 ft range	47.46
RESRE613	Wireless CO Detector	59.95
RESRE614	Wireless Smoke/Heat Detector	53.71
RESRE618	Trident Leak and Temp Sensor	31.22
RESRE619	Home Disaster Transmitter	41.22
RESRE622	NanoMax Door/Window, supports external	16.24
RESRE653	Cryptix™ Outdoor PIR	77.44



RESRE653



RESRE601



RESRE622



RESRE626



RESRE608

Add award-winning Wi-Fi lighting control to any Nest eco-system.

Turn on lights when motion is detected, blink lights when an alarm is detected, and turn off lights when the house is unoccupied.



DECORA SMART™ WI-FI & NEST®

Automate every home easily with flexible cloud-based solutions that ensure comfort, safety, and lower energy bills.



THE FUTURE IS ON®

LEVITON®



Firewolf Fire Alarm and Integrated Fire/Burg Kits

Scalable 32 to 255 points of addressable, conventional, and/or commercial wireless. UL864, 9th Edition. Pre-isolated Fire & Burg bus, separate, generous power supplies & separate service loops. More value out of the box with easy-to-use, menu-driven keypads. Cellular and internet reporting options are coming soon. Familiar Napco software. In housing battery capacity up to 32Ah. Dual line DACT, 4 Amps NAC.

NAPGEMCFW32CNVK	GEM-C 32 Zone Conventional Commercial Fire Alarm Panel Kit, includes: - Small 14x16 Mercantile Grade Red Enclosure - GEMC-PS24V4A-R 4Amp, 24V Power Supply - GEMC-F8ZCPIM Conventional 8-zone 2-wire Fire Input Module - GEMC-FK1 Red LCD Fire Keypad/Remote Annunciator	360.41
NAPGEMCFW32KT	GEM-C 32 Zone Commercial Fire Alarm Panel Kit, includes: - Small 14x16 Mercantile Grade Red Enclosure - GEMC-PS24V4A-R 4Amp, 24V Power Supply - GEMC-FW-SLC 32 Point Addressable Fire SLC Module - GEMC-FK1 Red LCD Fire Keypad/Remote Annunciator	384.77
NAPGEMCCOMBO32K	GEM-C 32 Zone Commercial Combo Fire/Burg Alarm Panel Kit, includes: - Large 14x25 Mercantile Grade Red Enclosure - GEMC-PS24V4A-R 4Amp, 24V Power Supply - GEMC-BM/PS Burg Module with Power Supply - GEMC-FW-SLC 32 Point Addressable Fire SLC Module - GEMC-FK1 Red LCD Fire Keypad/Remote Annunciator	389.64
NAPGEMCCOMBO128	GEM-C 128 Zone Commercial Combo Fire/Burg Alarm Panel Kit, includes: - Large 14x25 Mercantile Grade Red Enclosure - GEMC-PS24V7A-R 7Amp, 24V Power Supply - GEMC-BM/PS Burg Module with Power Supply - GEMC-FW-SLC 128 Point Addressable Fire SLC Module - GEMC-FK1 Red LCD Fire Keypad/Remote Annunciator	672.16



Firewolf Panel with Keypad

Modules for GEMC Panels

NAPSLECDMAFIRE	Sole Path Fire Alarm Cellular Communicator (Red), Verizon	139.83
NAPSLECDMAIFIRE	Commercial Dual Path CDMA Fire /Burglary radio in red plastic enclosure	149.83
NAPGEMCFK1	LCD Fire Keypad for GEM-C Combo System, Red	131.47
NAPGEMCF8ZCPIM	Conventional 8-zone 2-wire fire input module. Plugs into GEM-C Motherboard to provide support for conventional 2-wire smoke/fire detection device.	48.66
NAPGEMCFWSLC	Addressable SLC Fire Module, supports up to 128 addressable SLC Fire devices. Connects to the GEM-C control panel (2 max).	146.08
NAPGEMCBK1	LCD Burg Keypad for GEM-C Combo System, Req. GEM-C-BM/PS module.	97.37
NAPGEMCBMPS	Burg Module, with power supply, provides isolated 4-wire burg bus for burg keypads and devices, plus 12V power output.	77.89
NAPGEMCBSLC	Addressable SLC Burg Module, supports up to 128 addressable SLC burg devices. Connects to the GEM-C control panel (2 max).	146.08
NAPGEMCRECV	Commercial Fire and Burg UL wireless receiver, max of (4) receivers.	121.73
NAPGEMCCOMOD	Module generates the required 4-pulse cadence for carbon monoxide.	16.51



NAPGEMCBK1
NAPGEMCFK1



NAPFWCFSLCSMK
NAPFWCFSLCSMK6B

Addressable Analog SLC Fire Devices

NAPFWCFSLCPULL	Addressable SLC Fire Pull Station	63.70
NAPFWCFSLCSMK6B	Base required for FWCFSLCSMK and FWCFSLCHEAT devices	4.68
NAPFWCFSLCSMK	Addressable Analog SLC Photoelectric Smoke Detector	43.72
NAPFWCFSLCHEAT	Addressable Analog SLC Heat Detector 135°F fixed temperature	41.22
NAPFWCFSLCPRG2	Programmer needed for programming address into SLC devices Note: Auto-configure from panel can be used to program smokes and heats	137.32
NAPFWCFSLCDUCT	Addressable Analog SLC Photoelectric Duct Smoke Detector	123.65
NAPFWCFSLCDUCTR	Remote annunciator plate for FWCFSLCDUCT detector. Test / Reset.	58.40
NAPGEMC24VR	Add On 24V Regulator, required for FWCFSLCDUCT	38.92

Addressable Analog SLC Burglary Devices

NAPGEMCBSLC1PT	Burg Device - 1 Point Input Module	11.67
NAPGEMCBSLCDT	Burg Device - Dual Tech Motion Detector, PIR and Microwave, Range 40'x40'	72.04
NAPGEMCBSLCPIR	Burg Device - PIR Motion Detector, Range 50'x50'	97.37
NAPGEMCBSLCGB	Burg Device - Acoustic Glass Break Sensor, Max Range 25'	97.37



UL Commercial-rated wireless burglary and fire devices are available. See page 129.

Residential Burglary System Kits

NAPGEM1632DK1WL	310 Kit: GEM-P1632 panel, GEM-D1CA keypad, RECV-32, (3) TRANS-LP, & PET-PIR	292.22
NAPGEMSS311KIT	311 Kit: GEM-P1632 panel, GEM-D1CA keypad, RECV-32, (3) TRANS-LP, GEMKEYF & PET-PIR	292.22
NAP816PERFPAK	GEM-P816 panel, RP3DGTL keypad, and transformer	107.70
NAPK816PREMPAK	GEM-P816 panel, GEM-RP1CAE2 keypad, and transformer	160.61
NAPK1632INTROPK	GEM-P1632 panel in large enclosure, GEMK1CA keypad, and transformer	163.92
NAPGEMP1632INTR	GEM-P1632 panel and GEMRP1CAE2 keypad	163.92
NAPGEMP1664DK1P	GEM-P1664 panel in large enclosure, GEM-D1CA keypad and transformer	165.31
NAPGEMP1664VPSP	GEM-P1664 panel in large enclosure, GEM-K1VPS (built-in voice prompts, PIR, and siren) & xformer	185.96

Control4



SAVANT

Gemini Controller Quick Chart

(Control panel in enclosure only, Needs transformer, battery & keypad)

Part Number	On-board Zones	Maximum Total Zones	Maximum Wired Zones	Maximum Wireless Zones	Maximum Fire Zones	2-wire Fire Zones	Price
NAPGEMP816	8	16	16	16	16	2	69.57
NAPGEMP1632	8	32	32	32	32	2	84.32
NAPGEMP1664	8	64	64	64	64	2	88.57
NAPGEMP3200	8	48	32	48	32	2	130.88
NAPGEMP9600	8	96	96	96	96	8	253.50
NAPGEMX255	8	255	255	255	255	8	339.90

Commercial Burglary versions in mercantile-rated enclosures of the NAPGEM3200, NAPGEM9600, and NAPGEMX255 available. Call for information.

Gemini Keypads

NAPGEMDK1CA	Blue backlit 2-line custom LCD keypad with door, 4-zone expander	112.11
NAPGEMRP1CAE2	Green backlit 2-line custom LCD keypad with 4-zone expander, interior/instant keys	109.96
NAPGEMK1CA	Green backlit 2-line custom LCD keypad with 4-zone expander, stay/away keys	109.37
NAPGEMK1VPS	Blue backlit 2-line custom LCD keypad with natural voice prompts, integral PIR, siren and 4-zone expander	135.62
NAPGEMRP2ASE2	Green backlit fixed English LCD keypad, interior/instant keys	66.07
NAPGEMBIOREADER	Indoor/outdoor digital keypad with advanced optical biometric fingerprint reader	247.24
NAPISEEWLAP	Wireless access point, 802.11B/G/N, with power for wireless touchscreens and IP cameras	63.27
NAPIBRITABHW	Hardwired iBridge Touchscreen Tablet	272.73
NAPIBRITAB	iBridge Wireless Touchscreen Tablet with magnetic mounting frame	292.22
NAPIBRITABKIT	iBridge Wireless Touchscreen Tablet with mounting frame, charging station plus ISSEEWLAP	350.67
NAPIBRITABSTAND	Angled tabletop stand/docking station for use with IBR-ITABKIT Touchscreen (not included)	29.18



NAPGEMK1VPS



NAPGEMRP1CAE2



NAPIBRITAB



NAPISEEWLAP



NAPSLEGS34G

Gemini Modules

NAPPCIMINIUSB	High speed serial local PC download interface with USB	64.14
NAPGEMEZM8	8-zone Expander for all Gemini panels GEM-P816 and above	65.35
NAPIREMOTEMOD12	iRemote Control Internet Module provides remote Gemini Virtual Keypad, 12 months free service (no Z-Wave). Service starts @ \$2.50 per month	146.86
NAPIBRZREMOTE	Z-Wave™ Remote Control Module for home control, includes 12 months free service. Service starts @ \$2.50 per month	165.57
NAPCZREMOTE	Z-Wave™ Remote Control Module for Control4 integration, includes 12 months free service	165.57

Cellular and Other Panel Modules

NAPSLECDMA-C	StarLink Connect™ Universal Cell communicator - Verizon	129.85
NAPSLECDMA-Z	StarLink Connect™ Universal Cell communicator with Z-Wave - Verizon	149.83
NAPSLEWIFIMODUL	Module allows the StarLink Connect or StarLink Fire Dual Path radios	34.92
NAPSLECDMA	StarLink™ Up/Downloadable Verizon Universal alarm communicator	99.87
NAPSLEGS34G	StarLink™ Up/Downloadable GSM 3G / 4G Universal alarm communicator	99.87
NAPSLEDLCBL	For use with Starlink, allows up/downloading of Napco Gemini series panel (GEM-P816, P1632, P1664, P3200, P9600 & X255)	3.85
NAPSLEGS8D34G	StarLink™ Up/Downloadable GSM 3G / 4G alarm communicator for Express, GEM-P800 and GEM-P801 series panels	106.86
NAPSLEANTEXT	High quality remote antenna with 15 feet of high performance low-loss coaxial cable	68.15
NAPSLECDMAFIRE	Sole Path Fire Alarm Cellular Communicator (Red), Verizon	139.83
NAPSLECDMAIFIRE	StarLink Commercial Dual Path CDMA Fire and Burglary radio in red plastic enclosure	149.83

Hardwired Motion Detectors

NAPC100STE	Adaptive slimline PIR 30' x 35' range	20.66
NAPC100STE20	20' economy adaptive dual-tech motion, 20' range	19.56
NAPC100STEAM	Antimask with lookdown 50' x 40' range	21.81
NAPC100STLRE	Adaptive slimline PIR 30' x 35' range	25.27
NAPC200AP	Dual Tech microwave/PIR with pet immunity up to 100lb, 40' x 40' range	25.27
NAPP1R1510	Economical PIR with look-down, 30' x 30'	12.13
NAPP1R1680PT	Microprocessor PIR with 65lb pet immunity, 50' x 50' range	19.96
NAPIQPROFILER	"Self-Installing" PIR with 50lb pet immunity, 50' x 50' range	22.28
NAPIQVISION	PIR with 30lb pet immunity, 40' x 40' range	17.05
NAPM7300STE	Commercial adaptive microwave/PIR motion detector, 70' x 60' range	93.38



Wired UL Life Safety Devices

NAPFW2	2-wire photoelectric smoke detector	30.26
NAPFW2H	2-wire photoelectric smoke with heat detector	33.96
NAPFW2S	2-wire photoelectric smoke detector with sounder	29.18
NAPFWRM1	Reversing relay module, for interconnected sounders	20.41
NAPFW4	4-wire photoelectric smoke detector	37.64
NAPFW4H	4-wire photoelectric smoke detector with heat	41.27
NAPFT2200	Fire EOL relay module & 2.2k resistor module	10.93
NAPFT279	Fire EOL relay module & resistor module	12.44

Wireless Security Devices

NAPGEMTRANS2	Wireless door/window transmitter with remote sensor input	36.30
NAPGEMTRANSLP	Wireless low profile door/window transmitter with remote sensor input, white	32.74
NAPGEMTRANSLPBN	Wireless low profile door/window transmitter with remote sensor input, brown	32.74
NAPGEMRTRANS	Wireless recessed door/window transmitter	40.69
NAPGEMPIRPET	Wireless 50' x 50' PIR with 40lb pet immunity	97.08
NAPGEMPIR	Wireless 50' x 50' PIR	92.53
NAPGEMDT	Wireless adaptive Microwave/PIR sensor, 40' x 40' range	112.35
NAPGEMKEYF	Wireless 4-button keyfob transmitter	40.78
NAPGEMSMK	Wireless photoelectric smoke detector	83.91
NAPGEMHEAT	Wireless Rate-of-Rise 135 degree heat detector	48.60
NAPGEMGB	Wireless Gemini glassbreak, 25' coverage	83.15
NAPGEMWPPANIC	Wireless waterproof personal panic pendant	40.79
NAPGEMRECV255	255-point crystal-controlled wireless receiver module	204.66
NAPGEMRECV32	32-point crystal-controlled wireless receiver module	48.12
NAPGEMRECV96	96-point crystal-controlled wireless receiver module	141.65



Wireless UL Commercial Devices

NAPGEMCWLCO	Wireless Commercial Carbon Monoxide Detector	83.73
NAPGEMCWLHEAT	Wireless Commercial Fire Device - Heat Detector, 135 F	46.71
NAPGEMCWLSMK	Wireless Commercial Fire Device - Photoelectric Smoke Detector	87.63
NAPGEMCWLDT	Wireless Commercial Dual Technology Motion Detector, Range 40'x40'	111.99
NAPGEMCWLGB	Wireless Commercial Acoustic Glass Break Sensor, Max Range 25'	97.37
NAPGEMCWLPIR	Wireless Commercial PIR Motion Detector, Range 50'x50'	97.37
NAPGEMCWLWD2	Wireless 2 input Module, suitable for Commercial Fire and/or Burg	38.92



NAPGEMGB



NAPGEMSMK



NAPGEMHEAT



NAPGEMWPPANIC



NAPGEMTRANSLP
NAPGEMTRANSLPBN

System Sensor Combination Smoke & CO

SYSCOSMO-2W	Combination CO & Smoke Detector, 2-wire, requires COSMOD2W	93.09
SYSCOSMOD2W	2-wire i4 Interface Module, connect up to 12 compatible detectors	47.40
SYSCOSMO-4W	Combination CO & Smoke Detector, 4-wire, requires COSMOD4W	83.41
SYSCOSMOD4W	4-wire i4 Interface Module, connect up to 12 compatible detectors	40.98

SYSCOSMO2W



SYSCOSMOD2W

The i4 Series Combination CO/Smoke Detector includes a variety of features that simplify installation and maintenance while increasing the level of protection for your customers.

- Single device for CO and smoke detection that uses less wiring and fewer junction boxes
- Compatible with a wide range of control panels with the use of the required i4 Interface Module
- Sends distinct smoke and CO signals to the panel
- Sounds Temp 3 for smoke and Temp 4 for CO
- RealTest® enables functional gas testing using canned CO
- Drift compensation and smoothing algorithms provide false alarm immunity
- Replaceable electrochemical CO cell with 6-year end-of-life timer signals the panel and chirps to alert the homeowner
- LEDs display operational, CO and smoke status
- Versatile mounting allows wall or ceiling placement
- Built-in 85dB sounder

Call for Compatibility: As of press time, we were unable to test with all panels

System Sensor Heat Detectors



SYS5601P	Single-circuit Heat Detector, 135 fixed/rate-of-rise, non-powered	11.88
SYS5602	Single-circuit Heat Detector, 194 fixed/rate-of-rise, non-powered	11.88
SYS5603	Single-circuit Heat Detector, 135 fixed temperature, non-powered	11.49
SYS5604	Single-circuit Heat Detector, 194 fixed temperature, non-powered	11.88

Compatible with all EOL supervised control panels. N/O circuit. Power is not required.

COOPER Wheelock®

Commercial Horn Strobes



WHEHSR	Wall-mount Horn/Strobe - Red Candela 15/1575/30/75/95/110/135/185	47.47
WHESTR	Wall-mount Strobe only - Red Candela 15/1575/30/75/95/110/135/185	35.82

The Wheelock® Exceder Series of notification appliances features a sleek modern design that will please building owners with reduced total cost of ownership. Installers will benefit from its comprehensive feature list, including the most candela options in one appliance, low current draw, no tools needed for setting changes, voltage test points, 12/24 VDC operation, universal mounting base and multiple mounting options for both new and retrofit construction.

MACURCO
GAS DETECTION

Gas Detection

MCCM-E1	Carbon Monoxide Fixed Gas Detector, surface or 1-gang flush-mount	56.01
MCCME1-FTG	Carbon Monoxide Field Test Gas, aerosol, 20-30 tests per canister	55.22
MCGD-2B	Combustible Fixed Gas Detector, Methane or Propane, surface or 1-gang flush-mount	104.38
MCGD2A	Combustible Fixed Gas Detector, Methane or Propane, surface or 2-gang flush-mount	104.38



MCCM-E1



MCGD2A

The CM-E1 is a low voltage detector of Carbon Monoxide (CO). The CM-E1 is designed for connection to UL-Listed Fire Alarm/Burglary Control Panels. Alarm control panels that work on 12 or 24 VDC can provide battery backup to the CM-E1 detectors.

The GD-2B and GD2A are low voltage electronic detectors of combustible, heating type gases: methane (natural gas) and propane (LP) gas. Both are designed for connection to Fire Alarm/Burglary Control Panels. Both detectors are intended for installation in buildings in locations such as residences.

encore

Line-Voltage Smoke Monitoring

FireFighter is the easiest, most cost-effective way to add fire alarm monitoring to your new or existing control panel. It's great for existing line-voltage smokes.

FireFighter's unique technology monitors the existing UL smoke detectors within the home. When an alarm is detected a wireless signal is sent to the control panel which in turn contacts the central monitoring station.

2GIG-FF-345	Firefighter for 2GIG Wireless	36.25
ENCEC-FF433	Firefighter for DSC Wireless	36.22



Elk requires we publish MAP prices. Please call 800-282-8864 or use your on-line account for discounted Worthington Distribution Dealer prices.

Siren and Voice Drivers

ELK100	High perf. driver with 2 inputs & 2 volume levels	17.80
ELK110	Voice siren driver module for CO, intruder, and fire	33.23
ELK120	Recordable annunciator, 8 minutes, 4 channels	82.79
ELK124	Recordable annunciator in enclosure, 8 channels	119.81

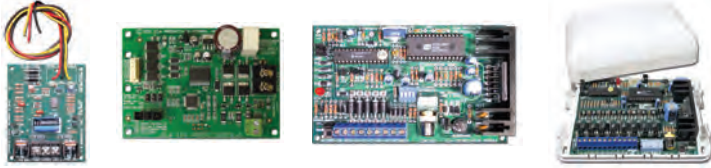

ELK100 ELK110 ELK120 ELK124

Universal Accessories

ELK9002	B Connectors (Plain), 500 pieces-Yellow	18.12
ELK9022	B Connectors (Gel), 500 pieces-White	21.68
ELK930	Telephone and doorbell ring detector	46.33
ELK999	Double-sided tape, 130 pc., 1/2" x 1" and 1/2" x 1/4"	7.81
ELK999A	Double-sided tape, 156 pc., assorted thickness	8.50



ELK9002/
ELK9022 ELK930 ELK999A

Relay Modules and Timers

ELK912	12V compact relay module, SPDT	6.16
ELK912B6	12/24V relay with big terminals, SPDT, 6-pack	32.95
ELK924	12/24V sensitive relay module, 1mA trigger DPDT	9.75
ELK9244	ELK924 sensitive relay, 4-pack	35.00
ELK960	12/24V delay timer, adjustable 1 sec.-60 min.	20.45
ELK9200	Heavy Duty Relay Contactor 110VAC Coil, 220VAC 60A load	60.53

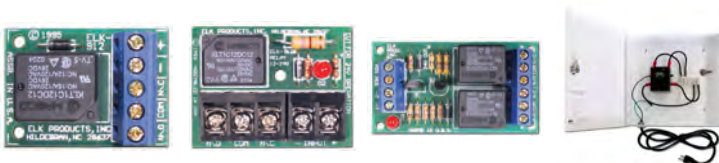

ELK912 ELK912B6 ELK924 ELK9200

Power Supplies

ELKP624	6, 12, or 24VDC power supply / battery charger	16.75
ELKP1215	12VDC power supply / battery charger kit with transformer	41.95
ELKP1417	14VDC 1.7A plug-in power supply	19.99



ELKP624 ELKP1215 ELKP1417

Speakers

ELKSP30	Exterior surface-mount 30W, 8 Ohm Speaker	12.10
ELKSP35	Interior surface-mount 20W with hardware	5.69
ELK73	Compact Echo speaker 20W 8 Ohm fits single gang box	8.77
ELKSP12F	Interior flush mount 12W fits single gang box	6.26
ELK1RT	30W speaker in stainless steel enclosure	40.55
ELKSL1*	Strobe for above speaker *- color: A-Amber, B-Blue, C-Clear, R-Red	20.29



ELK1RT ELKSP30 ELK73 ELKSP12F

Sirens (Compact, Self-Contained)

ELK74	Interior compact 105db with hardware (paintable)	10.01
ELKSS36	Two-tone interior siren	6.58
ELK150RT	118db siren in stainless steel enclosure. Use ELKSL1 to add strobe.	45.68
ELKSS30	Two-tone siren, 120db, surface	12.01



ELK150RT ELKSS30 ELK74 ELKSS36

Power Products

ELKBLT	Battery analyzer, 12V, .5A to 65A	143.00
ELKP1216	Plug-In Power Supply 12VDC 1.5A 2.5mm jack	19.99
ELK1250	Rechargeable 12V, 5Ahr battery	13.02
ELK1280	Rechargeable 12V, 8Ahr battery	18.54
ELKTRG2440	Transformer, 24V, 40VA, LED, ground, PTC	10.40
ELKTRG1640	Transformer, 16V, 45VA, LED, ground, PTC	10.40



ELK1280 ELK1250

ELKTRG1640/2440



THE PRO'S CHOICE FOR Integrated Security & Automation Control



Secure & Reliable

We put security first incorporating high-level encryption, multi-level authentication, and advanced processors in our controls, communicators, and wireless devices.

Integration Friendly

Our controls integrate with industry leading lighting, thermostat, A/V and software partners, providing truly customized control solutions.

Commercial & Residential

Not just for homes, M1 has the strength and flexibility needed in a variety of commercial applications, with features like access control, critical temperature monitoring, and email/text notifications.

World Class Support

Our award winning staff offers prompt and friendly support with minimal hold time and extensive product knowledge.



Power Supplies - Great for Adding More Power to your Leviton Omni Controller

ALTAL624	1.2A @ 12VDC & 0.75A @ 24VDC, requires 24VAC transformer feed, see below, board only	10.18
ALTAL624E	1.2A @ 12VDC & 0.75A @ 24VDC in enclosure, requires 24VAC transformer feed, see below	44.85
ALTSMP3E	2.5A @ 12VDC, 6VDC or 24VDC requires 24VAC 100VA transformer feed, with enclosure	50.48
ALTSMP5	4A @ 12VDC, 6VDC or 24VDC @ 4 amp of continuous output, requires 24VAC 100VA transformer feed, board only	39.11
ALTAL175ULB	1.75A @ 12/24VDC power supply with fire alarm interface, 2 power limited outputs, board only	51.40
ALTAL300ULB	2.5A @ 12/24VDC supervised AC and battery monitoring, limited output, board only	66.41
ALTAL300ULXR	UL fire listed 2.5A @ 12VDC or 24VDC in enclosure, supervised power supply/charger, 115VAC input	133.41
ALTAL400ULXB2	UL burglary listed 4A @ 12VDC or 3A @ 24VDC board only, power supply/charger, 115VAC input	115.36
ALTAL600ULM	6A @ 12/24VDC multi output power supply in enclosure, with fire alarm interface and power supervision	219.71
ALTAL600ULACM	6A @ 12/24VDC access power controller in enclosure with fire alarm interface, 8 fail safe or fail secure	235.62



ALTAL624



ALTAL624E



ALTAL175ULB



ALTAL400ULXB2



ALTSMP5



ALTAL600ULM

CCTV Power Supplies

ALTSAV4D	UL CCTV listed, 4 PTC outputs, 12VDC @ 5 amp, with power linecord	61.19
ALTSAV9D	UL CCTV listed, 9 PTC outputs, 12VDC @ 5 amp, with power linecord	71.90
ALTSAV18D	UL CCTV listed, 18 PTC outputs, 12VDC @ 5 amp, with power linecord	116.27
ALTV248	8 fuse-protected regulated outputs, 24VAC @ 4A power supply, 115VAC input	62.79
ALTV2416	16 fuse-protected regulated outputs, 24VAC @ 8A power supply, 115VAC input	101.31
ALTV615DC616UL	16 fuse-protected regulated outputs, 6-15VDC @ 6A power supply, 115VAC input	147.37
ALTV615DC1016	16 fuse-protected regulated outputs, 6-15VDC @ 10A power supply, 115VAC input	153.00
ALTALTV2432600U	12.5A @ 24VAC or 20A @ 28VAC 32 fused outputs; wall-mount	227.04
ALTR2416300UL	25A @ 24VAC or 10A @ 28VAC 16 fused outputs 2U rack-mount power supply	226.43



ALTV615DC616UL



ALTV615DC1016



ALTSAV4D



ALTSAV9D



ALTR2416300UL



ALTALTV2432600U



ALTV248

Low Voltage Coil DPDT Relays

ALTRBSN	12V/24VDC 15mA coil, 2A @ 115VAC/28VDC	7.96
ALTRBST	6V/12V/24VDC, 30mA coil, 2A @ 115VAC/28VDC	7.96
ALTRDC12	12VDC 86mA coil draw, 10A @ 120VAC/28VDC	14.14
ALTRAC24	24VAC 86mA coil draw, 10A @ 120VAC/28VDC	14.14
ALTRAC120	120VAC 12mA coil draw, 10A @ 120VAC/28VDC	14.14

Timers

ALT6062	12V/24VDC, 1-60 mins, 8A @ 115VAC/28VDC	16.15
ALTAT4	4 ch. 12/24V AC/DC, 10A @ 115VAC/28VDC	153.00
ALTDL1	Door control timer, 12/24V AC/DC, 1 sec. to 1 min.	28.28
ALTDL3	Same as above with rectified voltage output	36.72
ALTPT724A	Annual event timer 50 daily/weekly events	65.49

Siren Drivers



ALTALSD1

ALTALSD1	6V/12VDC operation, steady & yelp, current draw .5A to 1.8A depending on speaker	11.38
ALTALSD2	Same as above except current draw .3A to 1.22A depending on speaker	11.38

Note: Leviton Omni controller bell output is rated for 1A - Use Altronix for UL listing integrity

Batteries and Plug-in Transformers



ELKTRG2440

ELKTRG2440	Self resetting 24VAC/40VA transformer	10.40
ELKTRG1640	Self resetting 16.5VAC/40VA transformer	10.40
UB1250	12VDC/5AH sealed lead acid battery	10.61
UB1270	12VDC/7AH sealed lead acid battery	13.10

Worthington Distribution Carries the Full Altronix Product Line - Call for Pricing and Availability



Security Contacts

3/8" recessed stubby contact with 12" leads, 0.6" x 0.375" diameter, 1/2" gap (price per 10-pk)

GRI20RS-12-*	Standard model without resistor. Available in white or brown.	25.10
GRI7777-*	Model with 1K resistor for use with Leviton Security and Automation Omni	37.72
GRI20RS-12-*W2	Model with 2.2K resistor for use with ELK and Napco controls	37.72
GRI20RS-12-*W5	Model with 5.6K resistor for use with DSC panels	37.72
GRIN20RS-12-*	Rare Earth model without resistor. Magnet is 1/8" thick.	29.23
GRIN20RS-12-*W1	Rare Earth model with 1K resistor for use with Omni	41.84
GRIN20RS-12-*W2	Rare Earth model with 2.2K resistor for use with ELK and Napco controls	41.84
GRIN20RS-12-*W5	Rare Earth model with 5.6K resistor for use with DSC panels	41.84



GRI20RS-12-W



GRIN20RS-12-W

Note: When using contacts with resistors, use only one per zone

3/8" recessed stubby contact with screw terminals, 1.25" x 0.375" dia, .5" gap (price per 10-pk)

GRI20RS-T*	Standard model without resistor. Available in white or brown.	28.23
GRI7377-*	Model with 1K resistor for use with Leviton Security and Automation Omni	40.84
GRI7147-*	Model with 2.2K resistor for use with ELK and Napco controls	40.84
GRI8115-*	Model with 5.6K resistor for use with DSC panels	40.84
GRIN20RS-T*	Rare Earth model without resistor. Magnet is 1/8" thick.	32.35
GRIN20RS-T-*W1K	Rare Earth model with 1K resistor for use with Omni. Magnet is 1/8" thick.	44.96
GRI7714-*	Rare Earth model with 2.2K resistor for use with ELK and Napco controls	44.96
GRI7397-*	Rare Earth model with 5.6K resistor for use with DSC panels. Magnet is 1/8" thick.	44.96



GRI20RS-T-W

*- designates color option white or brown



GRIN20RS-T-W

Miniature surface mount contact, 1.50" x .375" x .302", 1" gap (price per 10-pack)

GRI110-12-*	Standard model with 12" leads, without resistor. Available in white or brown.	24.11
GRI110-12-*W1K	Model with 12" leads and 1K resistor for use with LS&A Omni	3.67
GRI110-12-*W2.2	Model with 12" leads and 2.2K resistor for use with ELK and Napco controls	3.67
GRI110-12-*W5.6	Model with 12" leads and 5.6K resistor for use with DSC panels	3.67
GRI110-T*	Standard model with terminals, without resistor. Available in white or brown.	25.48
GRI110-T-*W1K	Model with terminals and 1K resistor for use with LS&A Omni	38.09
GRI110-T-*W2.2K	Model with terminals and 2.2K resistor for use with ELK and Napco controls	3.81
GRI110-T-*W5.6K	Model with terminals and 5.6K resistor for use with DSC panels	3.81

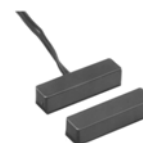

GRI110-12-B

Note: When using contacts with resistors, use only one per zone



GRI110-T-W

3/4" recessed door contact, 0.99" x 0.75" dia, 5/8" gap on steel (price per 10-pack)

GRI180RS-12-*	Standard model with 12" leads, without resistor. Available in white or brown.	34.47
GRI8080RS-T*	Standard model with terminals, without resistor. Available in white or brown.	34.47
3/4" dome switch, pressure switch, 1.105" x 0.74" dia		
GRIDS-01-*	Standard model with 12" leads, without resistor. Available in white or brown.	37.35
GRIDS-01T*	Standard model with terminals, without resistor. Available in white or brown.	40.72



GRI180RS-12-W



GRIDS-01T-W

Industrial and Overhead Door Contact (Sold Individually)

GRI4460A	Mini industrial set, 1" wide gap, armored lead	1.5" x .586" x .426"	Steel Doors	8.52
GRI4532	Floor-mount overhead door set, 3" wide gap	3.5" x 1.5" x .4'	Overhead Doors	10.24
GRI4400A	Rail-mount overhead door set, 2 1/2" wide gap	3.07 x 2.6 x 1.8	Overhead Doors	23.01
GRI4700-A	Track-mount overhead door set, 3" wide gap	1.75" to 4" channel	Overhead Doors	35.26



GRI4400A

GRI makes over 7,000 standard and custom contacts. Log on to www.grisk.com for more options.

Specialty Devices

GRI has a wide selection of specialty devices, call for details

GRIDM-1	Garage Monitor and Closer	59.07
GRIDPA-10D	Pool door alarm, notifies if children open door to pool area, 7-second delay for adults	42.28
GRICC-01	Current controller, control a closet light with just a door contact	35.66
GRISP-17	Panic button - single-gang stainless plate with red panic button and guard ring	17.07
GRI2600	Water sensor, normally closed, 4-wire, 12VDC	15.16
GRI2600T	Water sensor with terminals for 2 included remote sensors (GRI2600T-P), 4 wire	21.45
GRI2800	Surface mount water sensor, 2 wire, requires relay for security system	13.29
GRIWVS	Water shut-off valve w/ sensor, 1" pipe, additional locations with GRI2600	243.87
GRIHVACO	Protect outside HVAC unit from theft damage	24.77
GRIT8000-G	Freeze alarm, thermal 32-degree switch	32.30
GRIE-Z58COM-W	E-Z duct raceway 5/8" combo pack of connectors	7.77
GRIE-Z586-W	E-Z duct raceway 5/8" 6-pack of 6-ft lengths	38.89
GRIE-ZQR6-W	E-Z duct 1/4 round wire raceway- 6-pack	46.55
GRIPW375W	Pre-wire plug- low cost way to pre-wire new construction projects, 10-pack	1.12



GRIWVS



GRIPW375W



GRI2600



GRIDPA-10D



GRIE-ZQR6-W

EnviroAlert



WIEA800-IP



WITEMP-UL-S

WIEA800-IP	12-zone (8 wireless, 4 hardwired), temperature, humidity, water, gases, dry contacts and more. Cloud based access available (requires a fee-based subscription).	360.71
WIEA40012	4-zone, allows up to four external sensors: temp, humidity, and water detection	229.57
WIEA20012	2-zone, with on-board temperature sensor on 1st zone, choose your 2nd zone sensor	85.43
WITEMP-H-S	Stainless steel high temp probe (+32° to +302° F) (also available in waterproof, see below)	51.46
WITEMP-L-S	Stainless steel low temp probe (-58° to +158° F) (also available in waterproof, see below)	33.10
WIHA-IIIPLUS	Humidity sensor (5% to 95% R.H.)	120.03
WIW-S-S	Supervised water sensor, surface (for use with WB800 and EnviroAlert products)	28.35
WITEMP-UL-S	Ultra-low temp probe (-112° to +32° F) (For use only with EA800-IP)	66.20
WITEMP-L-W	Waterproof low temp probe (-58° to +158° F)	35.72
WITEMP-H-W	Waterproof high temp probe (+32° to +221° F)	54.33
WIEAWTS	Wireless temperature sensor* (+32° to +122° F)	95.55
WIEA-WHS	Wireless humidity sensor* (5% to 95% R.H.)	106.41
WIEA-WMFS	Wireless multi-function sensor*, requires Winland temp probe or W-S-S water sensor	91.43
WIW-UC-S	Water Sensor, Under-Carpet style, Supervised (will alarm if lead is cut)	49.84

*Wireless sensors are only for use with the EA800-IP

Temperature and Humidity Alerts



WITA-1

WITA-1	Temp Alert with dry contact output, adjustable high and low set points	65.20
WITA-2HL	Temp Alert with 2 dry contact outputs, adjustable high and low set points	62.45
WITA-40	Fixed Temp Alert with 2 dry contact outputs, NC for above 40° F/NO for below 40° F	15.86
WIMTA-1	Mechanical Temp Alert, 2 dry contact outputs, 50° to +130° F Operating Temperature	57.33

WaterBugs and Accessories



WIWBTX-319
WIWBTX-345



WIWB200



WIWB800



WIW-S-U



WIW-UC-U

WIWBTX-345	Wireless WaterBug for use with 2GIG panels, false alarm protection	36.85
WIWBTX-319	Wireless WaterBug for use with GE panels, false alarm protection	36.85
WIWB200	WaterBug 200, 12 or 24VAC or VDC, includes 1 WIW-S-U, use up to 6 sensors	55.71
WIWB350	WaterBug 350, 9V battery (battery not included), includes 1 WIW-S-U, use up to 6 sensors	96.17
WIWB800	WaterBug 800, 12 or 24VAC/VDC, includes 4 WIW-S-S, up to 8 zones or 16 sensors	279.78
WIW-S-U	Additional surface sensor for WB-200 and WB-350, 15' cable	19.48
WIW-UC-U	Under-carpet sensor for WB-200 and WB-350, 15' cable	62.20

Power Alert

WIPS-110	Power Alert, provides contact closure after 3-8 minutes of power loss, includes 15' of cable	49.84
----------	----------------------------------------------------------------------------------------------	-------

Worthington carries the full line of USP Products.



Miscellaneous Sensors



USP908

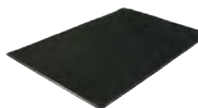

USPWPM-24

USP908	Pressure mat, 14" x 24" roll, use with security/automation panels	45.28
USP330W	Vibration sensor, use on walls, doors, windows, safes, etc., NC contact, non-powered, 10-pack	39.34
USPHUB2A-ES	Hold-up button, latching, double pole, double throw	13.86
USPF20	Temperature supervisory switch, opens at 40° F, use with security/automation panels	13.05
USPWLS	Water level sensor, NC/NO, use with security/automation panels	12.93
USP714*	Stick-on window glass break sensor, no power required. *B - Bronze, W-White	11.24
USPPLS	Power loss sensor for 110VAC, dry contact output, automatic reset	24.17
USP654	"Emergency" switch	2.50
USPCOR2	Foot triggered Hold Up Rail, DPDT latching relay, stainless steel	229.50
USPWPM-24	900MHz Wireless Pressure Mat - 18" x 24", embedded transmitter	301.92

DOORS.NET Controllers, Readers, Cards/Tags and Peripherals

Remote Monitoring/Control and Bio-readers



Remote Access:

Dealers have been asking for a way to access the system remotely with a smart phone or tablet. A new software called "DOORS.WEB" allows you this access. Just install it on the server and use any current browser. Users can now edit cardholders, open doors, lock doors, even lock-down the facility during an emergency.

Bio-Readers:

No more concerns about lost or stolen cards. No more shared codes. The finger is the key.

KSNXT-KIT4	NXT 4-door distributor kit, includes all the key Keri NXT components required to install a 4-door system, including readers, controller, adapter for direct PCB Ethernet connection, power supply and software	1,540.02
KSNXT-KIT2	NXT 2-door distributor kit, components for a 2-door system	934.25
KSNXT-2D	2-door access controller, 50K cardholders, expandable to 1024 doors	861.81
KSNXT-2D-MSC	Mercury-powered 2-door access controller, 50K cardholders, expandable to 1024 doors	929.26
KSNXT-4D	4-door access controller, 50K cardholders, expandable to 1024 doors	1,405.12
KSNXT-4D-MSC	Mercury-powered 4-door access controller, 50K cardholders, expandable to 1024 doors	1,569.99
KSNXT-4X4	4 x 4 I/O - optional local door control module, adds inputs and outputs to controller	177.36

Cards Readers and Keypads

KSNXT-1R	Euro-mount proximity reader - Entry/Access Version, 3.25" x 3.25" x 0.625	118.66
KSNXT-3R	Door-frame proximity reader - Entry/Access Version, 3.75" x 1.6" x 0.625	101.17
KSNXT-5R	Wall switch proximity reader - Entry/Access Version	118.66
KSNXT-KPK	Keypad Kit (includes NXT-6RK and NXT-RM3)	408.42
KSNXT-RM3	Reader interface module (for Wiegand & MS compatibility)	49.96
KSNXT-6RK	Keypad Prox Reader (requires NXT-RM3)	373.45
KSKPS-4-1	Power Supply for Keri controllers - 12VDC @ 2.5A, battery ready, no enclosure	83.68
KSKPS-5-1	Power Supply for Keri controllers - 12VDC @ 2.5A, battery ready, with enclosure	112.41



KSNXT-6RK KSNXT-3R



KSNXT-5R KSNXT-1R

Tiger II systems available and upgradable to Doors.net. Call for information

NXT readers now support HID cards without an interface card

Software and Licenses

KSDNET-APP	DOORS.NET Standard Edition - Access Control Software (free, request with controller)	Free
KSAPL-I2PC	Mini Appliance Pre-loaded with DOORS.NET - no need to deal with the client's PC or Windows issues. Safer and more secure	572.67
KSDNET-ADD-CL	Doors.NET Additional Client License - allows system access from multiple locations	322.24
KSDOORSWEB	Doors.Web Remote Access Software - allows current browsers to access and control system - Requires additional client licenses for each simultaneous remote connection	249.80

Have questions about licenses and Keri Systems? Give Worthington Distribution a call, (800) 282-8864.

Cards and Tags

Please Order the Correct Card for Your Keri System

KSNXT-C	Standard light proximity card, formatted for Keri DOORS.NET Controllers (Pack of 25)	56.83
KSNXT-K	Proximity key tag, formatted for Keri DOORS.NET Controllers (Pack of 25)	120.22
KSNXT-I	Multi-technology card without magnetic stripe for DOORS.NET Controllers (Pack of 25)	126.77
KSKC-10X	Standard light proximity card, formatted for Keri Tiger II Controllers (Pack of 25)	62.76
KSPKT-10X	Proximity key tag, formatted for Keri Tiger II Controllers (Pack of 25)	124.59
KSKC-26X	Standard light proximity card, formatted for Keri Intelliprox 2000 Controllers (Pack of 25)	116.47
KSPKT-26X	Proximity key tag, formatted for Keri Intelliprox 2000 Controllers (Pack of 25)	198.90
KSPSC-1	Standard Wiegand Light Proximity Card (Pack of 25)	60.89



Key Tag Standard Card

Wiegand & HID Compatible Accessories Available

Intelliprox 2000 Single-Door Access Control

All BioSync readers communicate in Wiegand - KSNXT-RM3 required for NXT systems

KSKBF-1FP	BioSync Fingerprint - only Reader	409.71
KSKBF-2PR	BioSync PR Fingerprint and Proximity Reader	469.09
KSKBF-3KP	BioSync KP Fingerprint and Keypad Reader	495.80
KSKBF-CNV	Ethernet-to-RS485 converter - one per system	77.79
KSDNET-BIO	BioManager Software (Free with purchase of BioSync Reader)	Free

BioSync™ Fingerprint Readers

Solid Biometric Technology at an Affordable Price!

Magnetic Locks

Electromagnetic locks, commonly called “mag-locks,” use a powerful magnet to hold the door shut. The door is released when power is removed. Electromagnetic locks are “fail-safe devices.” They can be controlled by access, telephone, and intercom systems. Depending on output of the system, a relay may be required.



ACS600S	Electromagnetic lock with 600 lbs. holding force, 12/24VDC, 400mA @ 12VDC, good for interior doors, UL listed	94.86
ACS600L	Electromagnetic lock with 600 lbs. holding force, status LED, 12/24VDC, 400mA @ 12VDC, good for interior doors, UL listed	116.63
ACS600LB	Electromagnetic lock with 600 lbs. holding force, bond sensor, door status sensor and status LED, 12/24VDC, 400mA @ 12VDC, good for interior doors, UL listed	149.28
ACS600D	Double electromagnetic lock with 600 lbs. holding force. 12/24VDC, 400mA @ 12VDC, good for double doors, UL listed	158.10
ACS600DLB	Double electromagnetic lock with 600 lbs. holding force, bond sensor, door status sensor and status LED, 12/24VDC, 400mA @ 12VDC, good for interior doors, UL listed	209.41
ACS600WP	Weatherproof electromagnetic lock with 600 lbs. holding force, 12/24VDC, 400mA @ 12VDC, good for gates	129.58
ACS1200S	Electromagnetic lock with 1200 lbs. holding force, 12/24VDC, 400mA @ 12VDC, good for exterior doors, UL listed	119.74
ACS1200L	Electromagnetic lock with 1200 lbs. holding force, status LED, 12/24VDC, 400mA @ 12VDC, good for exterior doors, UL listed	142.55
ACS1200LB	Electromagnetic lock with 1200 lbs. holding force, bond sensor, door status sensor and status LED, 12/24VDC, 400mA @ 12VDC, good for exterior doors, UL listed	191.78
ACS1200D	Double electromagnetic lock with 1200 lbs. holding force, 12/24VDC, 400mA @ 12VDC, good for double doors, UL listed	259.17
ACS1200WP	Weatherproof electromagnetic lock with 1200 lbs. holding force, 12/24VDC, 400mA @ 12VDC, good for gates	176.23

Also available in Dark Bronze finish. Call for part numbers. Additional mounting plates available for difficult installs.

Electric Strikes

ACSAES-100	BHMA Grade 1 Dual Voltage Electric Strike	83.97
ACSAES-200	BHMA Grade 2 Dual Voltage Electric Strike	104.70



ACSAES-100

Power Supplies

ACSAPS-300	3 Amps at 12VDC, 1.5 Amps at 24VDC	134.77	Sufficient power to support up to three magnetic locks or electric strikes plus required exit devices, thermal protection, Form C relay contacts, (SPDT), AC power status, tamper switch and camlock. Cabinet size: 14" L x 8-1/2" W x 3-1/2" D. UL listed
ACSAPS-300FT	ACSAPS-300 with one ACSPDFT Fire Module	173.12	
ACSAPS-3004C	ACSAPS-300 with one ACSPD4C, four output distribution	173.12	

Door Release Devices

ACSEB-1	Red Mushroom request-to-exit button, NO/NC	53.91
ACSTS-2	Request-to-exit, 2" green, illuminated LED button on 1-gang plate, SPDT	30.06
ACSNTS-1	No-Touch request-to-exit, 4" range, delay	53.91
ACSTS-2T	Timed request-to-exit, 2" green, illuminated LED button on 1-gang plate, SPDT, 2-45 second adjustable	76.71
ACSTS-14	Pneumatic timed request-to-exit. Green mushroom button, NO/NC	179.87
ACSTS-18	Under counter door release switch	20.73
ACSREB-1	Push-to-exit bar for 36" door	93.30
ACSSREX-100	Request-to-exit motion detector	85.53
ACSKP-100	Digital Keypad, surface-mount, indoor use	50.80
ACSKP-200	Weatherproof Digital Keypad, flush-mount	122.85
ACSKP-300	Mullion-mount Digital Keypad, card reader	122.85
ACSKP-400	Weatherproof Digital Keypad, surface-mount	122.85
ACSDE-1	Delayed Egress Station, double gang plate, alarm with keyswitch reset	128.55



Locks and Release Devices

SECO-LARM®

SLSD-998C-NUQ	Surface-Mount Electric Rim Strike - for many panic-bar doors	187.35
SLSK990A	Door strike, fail-secure 12VDC, 800 mA for doors with wood frames	22.04
SLSD-996CNUQ	Universal door strike, can be used in wood or metal frames, 3 faceplate styles, 280mA	74.94
SLE941SA600	Electromagnetic lock with 600 lbs. holding force, 12/24VDC, 500mA @ 12VDC, good for medium security doors	68.70
SLE941SA1200	Electromagnetic lock with 1200 lbs. holding force. 12/24VDC, 500mA @ 12VDC, good for high security doors	86.18
SLSD-997B-GBQ	Electric deadbolt, 5/8" bolt extension, fail safe, door position output, 12 VDC	106.16
SLSD-927PKC-NEQ	No-touch, request to exit single-gang plate, sensing range to 4"	27.48
SLSS-075C-PE	Plastic surface-mount push-button (also good for panic), NO/NC	2.19



SLSD-998C-NUQ

Speco's Value Line

If you're looking for an **economical option** for HD video surveillance Speco has it in **both HD-TVI and IP.**

HD-TVI Solutions



2MP Resolution
Intensifier® or IR LEDs
 Supports up to **2MP @ 30fps**
Weather Resistant
Fixed or Varifocal Lenses

IP Solutions



4MP, 3MP or 2MP Resolution
IR LEDs
Built-in Standard PoE
Weather Resistant
Fixed or Varifocal Lenses

HD-TVI Value Line Cameras		5 yr. warranty
VLD2TW	2MP IR Dome Camera, 3.6mm fixed lens, white housing	✓
VLB2TW	2MP IR Bullet Camera, 3.6mm fixed lens, white housing	✓
VLD1TW	2MP IR Dome Camera, 2.8-12mm lens, white housing	✓
VLB1TW	2MP IR Bullet Camera, 2.8-12mm lens, white housing	✓
HT71TG	2MP Mini-Turret Color Camera, 2.9mm fixed lens, dark gray housing	✓
HT71TW	2MP Mini-Turret Color Camera, 2.9mm fixed lens, white housing	✓
HINT71TG	2MP Intensifier® Mini-Turret Camera, 2.9mm fixed lens, dark gray housing	✓
HINT71TW	2MP Intensifier® Mini-Turret Camera, 2.9mm fixed lens, white housing	✓
HTMD2T	2MP IR Mini-Dome Camera with Junction Box, 3.6mm fixed lens, white housing	✓

IP Value Line Cameras		Junction Box Included		5 yr. warranty
O3VLD1	3MP Vandal Resistant Dome Camera, 2.8mm fixed lens, white housing	✓	✓	✓
O3VLB3	3MP Bullet Camera, 2.8mm fixed lens, dark gray housing	✓	✓	✓
O3VFDM	3MP Dome Camera, 2.7-12mm motorized lens, white housing	✓	✓	✓
O3VFBM	3MP Bullet Camera, 2.7-12mm motorized lens, white housing	✓	✓	✓
O4D1	4MP Dome Camera, 2.8mm fixed lens, white housing	✓	✓	✓
O2VLD5	2MP Dome Camera, 3.6mm fixed lens, white housing			✓
O2VLB5	2MP Bullet Camera, 3.6mm fixed lens, white housing			✓
O2VLD6	2MP Dome Camera, 2.8-12mm lens, white housing			✓
O2VLB6	2MP Bullet Camera, 2.8-12mm lens, white housing			✓



AHD - Analog HD

EverFocus offers a full line of AHD CCTV gear from cameras to recorders. Analog HD will send high resolution video (1080P) via the coaxial cable that all analog systems are already wired with!



Page 145

Flexible Intensifier

See in low light in color at night. The advanced Noise Reduction circuitry in the Intensifier camera coupled with the virtual 3D filter that is built into the DSP will allow your DVR to have 30% better compression.



Page 140-143

Arlo Cameras

With a full line of products, Arlo has a solution for any application. Between the Arlo Pro wireless camera or the Arlo Go Cellular camera, we can cover your whole home with one system!



Page 147



Bullet Cameras

Generally meant for outdoor use, bullet cameras allow for a greater range of lenses to fit your situation. Most models also include a sun screen to stop glare.

We Are Your CCTV Experts

Worthington's Technical Sales staff has years of experience designing CCTV systems for both residential and commercial applications. Our selection of products from Speco, EverFocus and more let us build you a solution for any job. From economical to full-featured, we can help you land that job.



Dome Cameras

When using cameras indoors, most homeowners prefer the look of a dome camera to that of a bullet. Dome cameras come in surface or flush mount versions and can have fixed or vari-focal lenses. Weatherproof domes can be mounted outside under overhangs and mounts are available if an overhang is not. Dome cameras may also have color choices.

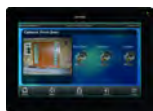
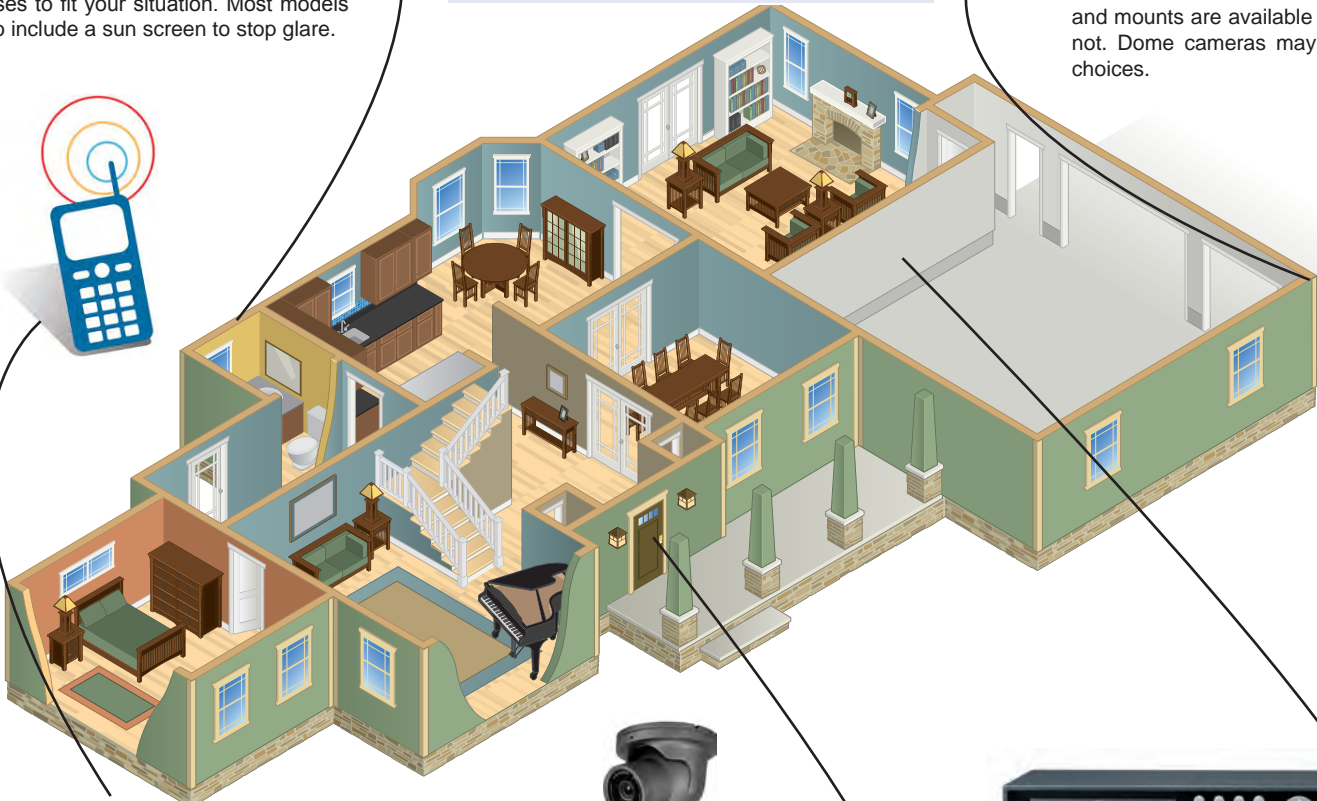

Touchscreen Integration

DVR's typically are designed for standalone operation, remote access with a web browser or custom applications for cell phones. Look to Everfocus for integration with Omni via refreshing JPEG images.



Door Cameras

A good selling feature for adding security cameras to a residential install is the ability to see who is at the door before you answer it. Door cameras give peace of mind to spouses who are home alone, allow them to avoid unwanted guests, and are a good crime deterrent as well.



DVR or NVR

A DVR or NVR is a good way to keep track of the activity that occurs inside or outside of a residence and can help aid police by providing evidence.

IP Dome Cameras



Camera Type	Indoor/Outdoor Dome	Indoor/Outdoor Dome	Indoor/Outdoor Dome	Indoor/Outdoor Mini-Dome	Indoor/Outdoor Dome	Indoor/Outdoor Vandal Dome
Low-Light Technology	50' IR	65' IR	98' IR	65' IR	160' IR	65' IR
Resolution	2MP (1080p)	2MP (1080p)	3MP	3MP	4K	2MP (1080p)
Lens	3.6mm	2.8-12mm	2.8mm	2.8 mm	2.7-12mm motorized	3-9mm motorized
Concealed Cable	Yes	Yes	Yes	Yes	Yes	Yes
Power	PoE 6W	PoE 6W	PoE 4W	PoE 5W	PoE 12.5W	PoE 10.4W
Size (inches)	5.7 Dia. x 4.5 H	5.7 Dia. x 4.5 H	4.3 Dia. x 3.2 H	5.12 Dia. x 3 H	6.3 Dia. x 4.6 H	5.5 Dia. x 4.8 H
Special	Value Priced	Value Priced	Value Priced	FIT Technology	Motorized Zoom	Heater
Part Number	STO2VLD5	STO2VLD6	STO3VLD1	STO3FDP9	STO8D2M	STO2D11M
Price	86.18	111.16	111.16	198.59	348.47	423.41

IP Video Recorders - NVR



EZ-Camera Autofind:

All Speco NVRs feature Autofind. The NVR creates a separate network that is dedicated to the IP cameras and automatically detects Speco cameras on that network. They appear on the screen within 60 seconds of being connected. NSP series NVRs have a built in PoE switch with a port for each camera. Autofind gives you all the advantages of IP video but removes the networking hassle often associated with it.

NSL & WNS Series - Add Your Own PoE Switch

STN4NSL1TB	4-channel NVR, 1TB HDD, desktop/rack	262.29
STN8NSL2TB	8-channel NVR, 2TB HDD, desktop/rack	460.88
MAU2V	2-space Vented Rack Shelf - Fits NS NVRs	57.75
STN4WNS1TB	4-channel NVR, 1TB HDD, wall-mount (9TB HDD max)	423.41
STN8WNSP2TB	8-channel NVR, 2TB HDD, wall-mount (9TB HDD max)	660.72
STN16WNS2TB	16-channel NVR, 2TB HDD, wall-mount (12TB HDD max)	685.70

What's the difference between the series?

All Speco recorders automatically detect Speco IP cameras in under 60 seconds. No IP addresses or credentials to worry about. NXP models feature a self-contained PoE switch that lets you simply plug in the cameras and go. The NSL and WNS models require you to add your own PoE switch.



NXP Series

NXP Series - 4K with PoE Switch Built-In

STN8NXP2TB	8-channel NVR, 4-port PoE switch, 2TB HDD, desktop (16 TB HDD max)	485.86
STN8NXP4TB	8-channel NVR, 4-port PoE switch, 4TB HDD, desktop (16 TB HDD max)	623.25
STN16NXP4TB	16-channel NVR, 8-port PoE switch, 4TB HDD, desktop (16TB max)	848.07
STN16NXP8TB	16-channel NVR, 8-port PoE switch, 8TB HDD, desktop (16TB max)	1,122.85
MAU2V	2-space Vented Rack Shelf - Fits NSP NVRs	57.75



NS Series

NS Series - 4K - 32 Channels - Add Your Own PoE Switch

STN32NS9TB	32-channel NVR, 9TB HDD, desktop (18TB max)	262.29
MUX500110	Extend 2 IP cams 650' at 100Mbps or 1 mile at 25Mbps	527.08
MUX500111	Extend 1 IP cam 1600' w/ 14 Watts of PoE	79.31



MUX500110

IP Bullet Cameras



Indoor/Outdoor Bullet	Indoor/Outdoor Bullet	Indoor/Outdoor Bullet	Indoor/Outdoor Bullet	Indoor/Outdoor Bullet	Camera Type
50' IR	80' IR	98' IR	98' IR	Intensifier	Low-Light Technology
2MP (1080p)	2MP (1080p)	3MP	4MP	2MP (1080p)	Resolution
3.6mm	2.8-12mm	2.8mm	3.6mm	2.8-12mm motorized	Lens
Yes	Yes	Yes	Yes	Yes	Concealed Cable
PoE 6W	PoE 6W	PoE 4W	PoE 6.5W	PoE 6W	Power
7.2 x 2.5	8.62 x 3.43	6.9 x 2.75	6.5 x 2.8	11.4 x 3.5	Size (inches)
Value Priced	Value Priced	Value Priced	2-Way Audio	Heater	Special
STO2VLB5	STO2VLB6	STO3VLB3	STO4B7	STO2IB8M	Part Number
86.18	111.16	111.16	143.64	330.98	Price

IP/Analog Hybrid Video Recorders

HS series hybrid recorders provide the ultimate in flexibility at a great price point. Offered in 8 and 16 channel units, the installer can configure each channel to be IP or 950H analog. It's perfect for analog upgrades where some analog cameras can stay in place and new installs where some cameras don't need to be very high resolution. One IP channel can record at 5MP and the rest at 1080p, and analog channels record at 720p.

STD8HS1TB	8-channel Hybrid NVR, 1TB HDD	610.76
STD8HS2TB	8-channel Hybrid NVR, 2TB HDD	673.21
STD8HS3TB	8-channel Hybrid NVR, 3TB HD	773.13
STD16HS2TB	16-channel Hybrid NVR, 2TB HDD	723.17
STD16HS3TB	16-channel Hybrid NVR, 3TB HDD	823.09
STD16HS4TB	16-channel Hybrid NVR, 4TB HDD	898.03

Available HDD sizes: 1TB, 2TB, 3TB, 4TB, 6TB, 9TB, 12TB



Luxul Networking

LUXXMS-1010P	10-port Switch, 8 ports PoE, 15.4W per port	224.82
LUXXFS-1816P	Switch, 16 Fast Ethernet PoE+ ports and 2 Gigabit uplink ports, perfect for 16-channel NVRs	337.23
LUXXMS-2624P	Switch, 24 Gigabit PoE+ ports and 2 Gigabit/SFP ports, managed	646.98



LUXXFS-1816P



LUXXMS-2624P

3MP, 4MP, and 8MP/4K IP Cameras

STO3VLB3	3MP Indoor/Outdoor Bullet, 2.8mm lens, 98' IR, UL Listed, Junction Box Included	111.16
STO3VLD1	3MP Indoor/Outdoor Dome, 2.8mm lens, 98' IR, UL Listed, Junction Box Included	111.16
STO3VFBM	3MP Indoor/Outdoor Bullet, 2.7-12mm motorized lens, 190' IR, UL Listed, Junction Box Included	136.14
STO3VFD1	3MP Indoor/Outdoor Dome, 2.7-12mm motorized lens, 98' IR, UL Listed, Junction Box Included	136.14
STO4B7	4MP Indoor/Outdoor Bullet, 2.8mm lens, 98' IR, UL Listed, Junction Box Included	143.64
STO4D1	4MP Indoor/Outdoor Dome, 2.8mm lens, 98' IR, UL Listed, Junction Box Included	173.61
STO4B2M	4MP Indoor/Outdoor Bullet, 2.7-12mm motorized lens, 160' IR, UL Listed, Junction Box Included	298.51
STO4D2M	4MP Indoor/Outdoor Dome, 2.7-12mm motorized lens, 160' IR, UL Listed, Junction Box Included	298.51
STO8B2M	8MP/4K Indoor/Outdoor Bullet, 2.8-12mm motorized lens, 160' IR, UL Listed, Junction Box Included	348.47
STO8D2M	8MP/4K Indoor/Outdoor Dome, 2.8-12mm motorized lens, 160' IR, UL Listed, Junction Box Included	348.47

PTZ IP Cameras

PTZ cameras are great in applications where there will be a guard monitoring the video. They can also be configured to run a pre-determined tour. In this mode, the camera can sweep back and forth and cover a large area.

STO2P12X	2MP Indoor/Outdoor PTZ IP Camera, 5.1-61.1mm, 12x optical zoom lens	373.45
STO2P4X	2MP Indoor/Outdoor Mini-PTZ IP Camera, 2.7-11mm, 4x optical zoom lens	168.62
STO4P30X	4MP Indoor/Outdoor PTZ IP Camera, 4.5-135mm, 30x optical zoom lens	935.50
STKBDPTZ1	IP PTZ Keyboard Controller	311.63



STO2P4X



STO4P30X

TVI Cameras - 1080p Over Coax



Camera Type	Indoor/Outdoor Dome	Indoor/Outdoor Dome	Indoor/Outdoor Vandal Dome	Indoor/Outdoor Mini Dome	Indoor/Outdoor Dome	Indoor/Outdoor Turret	Indoor/Outdoor Mini Turret
Low-Light Technology	32' IR	100' IR	Intensifier	50' IR	66' IR	90' IR	35' IR
Resolution	1080p	1080p	1080p	1080p	1080p	1080p	1080p
Lens	3.6mm	2.8-12mm Auto-Iris	2.8-12mm Auto-Iris	3.6mm	3.6mm	3.6mm	2.9mm
Heater	No	No	No	No	Yes	Yes	No
Concealed Cable	Yes	Yes	Yes	Yes	Yes	Yes	Yes
Power	12VDC 400mA	12VDC 400mA	12VDC/24VAC 500mA/195mA	12VDC 200mA	12VDC/24VAC 500mA/195mA	12VDC/24VAC 580mA/218mA	12VDC 100mA
Size (inches)	4.5 Dia. x 5 H	5.7 Dia. x 4.5 H	5.1 Dia. x 3.5 H	3.5 Dia. x 2.3 H	4.7 Dia. x 3.5 H	3.8 Dia. x 4.65 H	2.36 Dia. x 2.2 H
Part Number	STVLD2TW	STVLD1TW	STHT7246T	STHTMD2T	STHT5941T	STHT6041T	STHT71T* * White or Grey
Price	57.45	81.18	148.63	161.12	161.12	173.61	86.18

TVI Technology Explained



TVI is an analog video standard that transmits 1080p video over coax cable. Use Speco's new TVI cameras and recorders and upgrade your existing analog over coax systems to full 1080p HD - no new wiring! TVI gives you the 2 Megapixel performance you thought you could only get on IP systems but it runs over coax - even RG59 - up to 1000'. TVI recorders are backwards compatible with traditional cameras. That means you can upgrade an older system and still leave some of the existing cameras in place. TVI systems are also great for budget-conscious new installs.

VT Series Recorders

STD4VT1TB	4-channel, 1TB	286.02
STD4VT2TB	4-channel, 2TB	335.98
STD8VT2TB	8-channel, 2TB	460.88
STD8VT3TB	8-channel, 3TB	573.29
STD16VT3TB	16-channel, 3TB	623.25
STD16VT4TB	16-channel, 4TB	685.70
STD8HT2TB	8-channel, 2TB, Hybrid - also supports IP	685.70
STD16HT4TB	16-channel, 4TB, Hybrid - also supports IP	1,147.83

VT recorders use the same user interface as IP NVR models and also support the same smartphone apps. They also feature EZ Setup, which speeds initial configuration of networking, DDNS, and recording. HDMI video output supports high definition monitors. Searching is made simple by using still thumbnail images to narrow down the time of an event. Users can then easily copy the video to a USB drive.



VT Series Wall-Mount Recorders

STD4WVT1TB	4-channel, 1TB	273.53
STD4WVTP1TB	4-channel, 1TB, 12VDC 3A power	335.98
STD4WVT2TB	4-channel, 2TB	323.49
STD4WVTP2TB	4-channel, 2TB, 12VDC 3A power	385.94
STD8WVT2TB	8-channel, 2TB	448.39
STD8WVTP2TB	8-channel, 2TB, 12VDC 5A power	510.84
STD8WVT3TB	8-channel, 3TB	560.80
STD8WVTP3TB	8-channel, 3TB, 12VDC 5A power	623.25
STD16WVT3TB	16-channel, 3TB	623.25
STD16WVT4TB	16-channel, 4TB	685.70



VT wall mount recorders are exactly the same as the standard desktop/rackmount versions, but they come in a metal wall mount enclosure. They are great for equipment rooms and look like a security panel when installed. Models with P in the part number include a 12V power supply to power the cameras.

Altronix Power Supplies for Cameras

ALTV615DC48ULM3	12VDC, 4A, 8 fused outputs	89.97
ALTV615DC616UL	12VDC, 6A, 16 fused outputs	147.37
ALTSAV4D	12VDC, 5A, 4 PTC protected outputs	61.19
ALTV248	24VAC, 4 Amp, 8 fused outputs	62.79

TVI Cameras - 1080p Over Coax



Indoor/Outdoor Bullet	Indoor/Outdoor Bullet	Indoor/Outdoor Bullet	Camera Type
60' IR	100' IR	Intensifier	Low-Light Technology
1080p	1080p	1080p	Resolution
3.6mm	2.8-12mm Auto-Iris	2.8-12mm Auto-Iris	Lens
No	No	Yes	Heater
Yes	Yes	Yes	Concealed Cable
12VDC 400mA	12VDC 400mA	12VDC/24VAC 500mA/195mA	Power
2.5 Dia. x 7.2 L	3.4 Dia. x 8.3 L	3.9 Dia. x 8.3 L	Size (inches)
STVLB2TW	STVLB1TW	STHTINT70T	Part Number
57.45	81.18	211.08	Price

Cable

Siamese cable includes 95% bare copper RG59 and braided 18/2 for power. It's the fastest way to wire for cameras.

WAVH59182BCRBK2	1000' Black Siamese Cable	172.36
WAVH59182BCRBK3	500' Black Siamese Cable	89.93



Battery Backup

Using a battery backup on a camera system not only ensures constant recording through power interruptions, it also protects the recorder from damage that can occur as a result of brief outages.



TRLBC350	350 VA Strip-Style Battery Backup	50.58
----------	-----------------------------------	-------

TVI Camera Features



Heater

Have you ever had a camera fog up or accumulate condensation on the inside of the glass? It happens because the air outside the camera is cold and dry, and inside is warm.

Some cameras shown here features a heater circuit. They utilize a pair of large resistors that get powered periodically when it's cold. They heat up the glass and prevent fog and condensation.

IR Illumination

This is the most popular form of night capable camera. It uses invisible Infrared light and switches to black and white to provide video in the dark. The biggest pro is that it can produce an image in total blackness. The con is that it can only light up so far from the camera, and can wash out when the IR hits a reflective object.

Intensifier Illumination - Color Image at Night

Intensifier uses a chip in the camera to amplify any light that is in the scene. Pros include a full color image at night and low power consumption. The con? There has to be some amount of ambient light for the camera to use.



TVI Baluns

Do you want to run your TVI cameras over Cat 5/6? It's no problem with these baluns. They give you a BNC to RJ45 connector and convert the video signal to be transmitted over twisted pair.



STTVIUTP	TVI Balun	5.00
STTVIUTPPT	TVI Balun with Pigtail	6.24

TVI Kits

STZIPT4B1	4-channel 1TB DVR, (4) TVI outdoor bullet cameras w/ 60' IR 12VDC	410.92
STZIPT4D1	4-channel 1TB DVR, (4) TVI outdoor dome cameras w/ 30' IR 12VDC	410.92
STZIPT84B2	8-channel 2TB DVR, (4) TVI outdoor bullet cameras w/ 60' IR 12VDC	623.25
STZIPT84D2	8-channel 2TB DVR, (4) TVI outdoor dome cameras w/ 30' IR 12VDC	623.25
STZIPT88B2	8-channel 2TB DVR, (8) TVI outdoor bullet cameras w/ 60' IR 12VDC	873.05
STZIPT88D2	8-channel 2TB DVR, (8) TVI outdoor dome cameras w/ 30' IR 12VDC	873.05
STZIPT8BD2	8-channel 2TB DVR, (4) TVI outdoor bullet cameras w/ 60' IR, (4) TVI outdoor dome cameras w/ 30' IR 12VDC	873.05

Save big with Speco's TVI kits. Just add wire and a 12VDC power supply and you are ready to go.





Smart phone. **Smart home.**

Schlage Sense™ provides you with new ways to access and control your entrances with the Schlage Sense app and Apple's new Home app — so everything you need for a worry-free day is already in your pocket.

ALLEGION 

© 2018 Schlage Lock Company | [schlage.com](https://www.schlage.com)

ELUX DVRs - 1080p Resolution - Support for AHD and TVI Cameras

All the models below provide a JPG output for each channel. This makes them a great solution for showing analog cameras on OmniTouch 7 screens and the SnapLink Mobile App.

EFELUX41T	TVI/AHD 4-channel 1080p DVR, 1TB hard drive	243.56
EFELUX42T	TVI/AHD 4-channel 1080p DVR, 2TB hard drive	299.76
EFELUX81T	TVI/AHD 8-channel 1080p DVR, 1TB hard drive	318.50
EFELUX82T	TVI/AHD 8-channel 1080p DVR, 2TB hard drive	374.70
EFELUX164T	TVI/AHD 16-channel 1080p DVR, 4TB hard drive	624.50

New AHD Equipment - Record in Full 1080p Over Coax!
About AHD: Analog High Definition, or AHD, is a new video transmission technology from EverFocus. It allows video to be sent in full HD resolution over standard coax cable - even RG59. AHD recorders are also compatible with TVI, 720p, 960H, or standard analog cameras. This makes it great for retrofit installations since you can leave some of the original cameras in place and upgrade others.



The ELUX DVRs have an MJPEG video stream that can be enabled in the setup menu. This stream is compatible with the OmniTouch 7 and SnapLink Mobile apps. Since AHD cameras don't run over IP, these systems couple well with Omni systems. There is no need for complicated managed switches or the configuration of VLANs. The end user experience is still a 1080p picture, but the set up is drastically easier.



Analog HD (AHD) Cameras - 1080p Resolution

Analog HD (AHD) cameras send a 720p or 1080p signal over standard coax cable to AHD DVRs. It dramatically reduces system cost and set up time and allows you to offer HD video surveillance upgrades to customers with standard analog systems in place. All models feature a defog function that can be set to periodically heat up the cover to reduce fogging.



Outdoor Color Dome	Indoor IR Dome	Indoor Color Dome	Outdoor Color Dome	Indoor IR Dome	Camera Type
-	100' IR	-	-	100' IR	Low-Light Technology
720p	720p	1080p	1080p	1080p	Resolution
2.8-12mm Auto-iris	2.8-12mm Auto-iris	3.6mm	2.8-12mm Auto-iris	2.8-12mm Auto-iris	Lens
Yes	Yes	Yes	Yes	Yes	Concealed Cable
12VDC/24VAC 1.6W/1.7W	12VDC/24VAC 3.7W/3.5W	12VDC 1.2W	12VDC/24VAC 1.6W/1.7W	12VDC/24VAC 3.7W/3.5W	Power
Defog available in black and white	Defog available in black and white	Defog available in black and white	Defog available in black and white	Defog available in black and white	Special
5.24 Dia. x 3.8	5.24 Dia. x 3.8	4.25 Dia. x 3.54	5.24 Dia. x 3.8	5.24 Dia. x 3.8	Size (inches)
EFED910	EFED930	EFECD900F	EFED910F	EFED930FB	Part Number
93.68	111.16	56.20	93.68	111.16	Price

Battery Backup



Using a battery backup on a camera system not only ensures constant recording through power interruptions, it also protects the recorder from damage that can occur as a result of brief outages.

TRLB350	350 VA Strip-Style Battery Backup	50.58
---------	-----------------------------------	-------

Cable

Siamese cable includes 95% bare copper RG59 and braided 18/2 for power. It's the fastest way to wire for cameras.

WAVH59182BCRBK2	1000' Black Siamese Cable	172.36
WAVH59182BCRBK3	500' Black Siamese Cable	89.93

Altronix Power Supplies for Cameras

ALT615DC48ULM3	12VDC, 4A, 8 fused outputs	89.97
ALT615DC616UL	12VDC, 6A, 16 fused outputs	147.37
ALTS4V4D	12VDC, 5A, 4 PTC protected outputs	61.19
ALT248	24VAC, 4 Amp, 8 fused outputs	62.79

**BECOME CERTIFIED
FIBARO SYSTEM INSTALLER**



We invite installers, electricians and practitioners in the construction industry



1 day



Lectures and practices



Training materials

Find out more

fibaro.com/installer



Wire-Free Cameras



ARLVMC4030-1T9N



ARLVMC4030P-100

The Arlo Video System offers a new perspective to home security. The Arlo Wire-free HD Camera breaks the mold of traditional security cameras and gives the freedom to install cameras across the property, indoors or out. The combination of easy installation, battery-operated wire-free design, and weather-resistant construction makes it a perfect fit for virtually any placement, even in a tree. Can be installed in 10 minutes or less.

The Arlo Video System gives users the ability to make adjustments themselves, including relocating the camera and replacing batteries.



ARLVMC3030

ARLVMB4000-1T9N	Arlo Pro Base Station (required) The Arlo Pro Base Station is forward and backward compatible, and thus supports the Standard Arlo Camera as well as the Arlo Pro Camera	69.00
Pro Series		
ARLVMC4030-1T9N	Arlo Pro 720p HD Wire-free Camera.	179.00
ARLVMC4030P-100	Arlo 2 Pro 1080p HD Wire-free Camera.	199.00
ARLVMA4400	Arlo Pro Rechargeable Battery.	55.00
ARLVMA4400C	Arlo Pro Charging Station.	50.00
ARLVMA4200B	Arlo Pro Camera Skins (3 pack, Black).	27.00

Arlo Standard

ARLVMC3030	Arlo Wire-free Camera.	116.00
ARLVMA1200B	Camera Skins (3 pack, Black).	23.00
ARLVMA1000B	Arlo Camera Outdoor Mount (Black).	20.00

Arlo GO (cellular, no base station required)

ARLVML40301T9NA	Arlo Go Mobile HD Security Camera.	387.00
ARLVMA4410	Arlo Go Rechargeable Battery.	57.00
ARLVMA4220K	Arlo Go Camera Skins (2 pk, Black & Green).	17.00
ARLVMA4210	Arlo Go Camera Skins (Camo).	33.00
ARLVMA4600	Solar Panel for Arlo Pro, Arlo Pro 2, & Arlo Go.	80.00

Peace of Mind. Anytime. Anywhere.

With brilliant HD video quality, two-way audio, live streaming, free cloud recording, instant alerts, and other smart features, the Arlo family of smart security cameras lets you watch over what you love from every angle, indoors and out, day and night.

100% Wire-Free

Stay completely free of cords and wiring hassles with Arlo Go, Arlo Pro and Arlo cameras.

Weather-Resistant

Arlo Go, Arlo Pro, and Arlo cameras are IP65-certified weather-resistant and not afraid to brave the snow, rain, or heat.

Free Cloud Recording

Keep the past 7 days of motion- and sound-triggered recordings of up to 5 cameras for FREE.

Live View

View live and record videos anytime. Video to be viewed, downloaded, and shared for 7 days, for FREE.

Integrate the Arlo Video System with HomeControl Flex from Telguard.

With HomeControl Flex and an Arlo Wire-free HD Camera, enable remote viewing of event-triggered clips, images and live video from anywhere, on a smartphone, computer or tablet.

Get More Angles Covered

Expanding your Arlo system is a breeze. Connect up to five cameras for free. Upgrade to add up to 15 cameras per account.

Your Schedule. Your Terms.

Use smart scheduling to set Arlo's work schedule to fit yours. Geo-fencing, custom modes, and IFTTT are just a few of the possible ways to personalize your Arlo system to your needs and preferences.



ARLVMA4210



ARLVML40301T9NA



ARLVMA4600



MCA-88X 8-Zone Whole House Audio with XStream™

Next Generation Multizone Audio Controller Has Arrived

Building on Russound's legendary reliability, simplicity, and sound quality, the new multizone controllers now offer lightning fast response time, an array of digital inputs, and quicker configuration. The evolutionary MCA-88X, an 8-source, 8-zone controller, features built-in XStream™ Technology, enabling popular streaming content from the cloud, home network, tablets and phones—all from a single component. The intuitive MyRussound™ app conveniently controls the entire system and displays metadata using tablets and phones. In addition, a wide assortment of keypads, touchscreens and hand-held remotes ensures optimum control for any location. Engineered for flexible configuration and easy integration, the controllers satisfy any design challenge. The system allows multiple controllers to be combined to create up to 48 independent zones. The new Russound line of multizone controllers delivers the perfect balance of popular music content, audio performance and optimal control.



RSMCA-88X Front



RSMCA-88X Back

RSKT2-88X	MCA-88X, (6) white MDK-C6 keypads, remote, (7) 845.1 emitters, rack ears	3,014.96
RSMCA-88X	8-source audio input, 1-XStream source, 8-zone audio output with 40W/Ch (zones 1-6, line out 7-8), routed IR, RS-232, paging, rack ears,	1,818.96

Features:

- 8 zones: 40W/Ch zones 1-6, zones 7 and 8 line out only
- Fixed / variable line out for all 8 zones
- 6 amplified zones @40 wpc
- Built-in XStream™ streaming audio source (MCA-88X)
- 8 analog inputs / 3 digital coax inputs / 1 optical input
- Input 8 can be reassigned as an auto-sensing page
- Source loop outputs for all sources
- 6 routed IR outputs plus a global IR out
- Built-in IR learner and library IR codes
- RS232 and IP controllable
- Global 12v trigger in/out
- Programming software is a free download
- Programming and updates via USB port or Ethernet
- Zone Linking locks multiple zones together for all functionality
- Source Linking ensures selected zones always play the same source
- Source Mapping allows sources to only be available in selected zones
- Audiophile quality DACs support high resolution audio (24 bit/192kHz)
- Adjustable bass, treble, balance and loudness
- Connection for optional BTC-1X Bluetooth transceiver
- Rackmountable
- Expandable to up to 48 zones
- Compatible with Leviton OmniPro II & Fibaro HC2

Double Warranty with Russound Speakers! See p.154



Look on page 150 for Russound MCA-88 which has all the features of the MCA-88X without the XStream™ streaming audio source. It can be used for expanding beyond the 8 zones of the MCA-88X.



Four-Stream Four-Zone Audio



RSXZONE4



Features:

- Control with Fibaro HC2
- 4 independent streaming audio players
- 4 amplified zones, expandable to 16 zones
- Dedicated stream per zone
- Controllable by the XTS Touchscreen or the MyRussound App
- XStream™ complement of streaming sources including Spotify, Pandora, AirPlay and more
- Mix and match with other XStream Series components for versatile designs



The XZone4 Four-Stream, Four-Zone Audio System is a complete streaming media solution that gives Russound installers a single-box package that is easy to install via a simple browser-based configuration, using a smartphone, tablet, or laptop.

As part of the scalable XStream Series of products, the XZone4 can be used with other XZone4 devices or any other XStream product (XSource) to become part of a single system of up to 16 zones of audio. It works with the MyRussound App for iOS/Android phones and tablets.

Russound created the XZone4 to become the go-to solution for bringing streaming media to wholehouse audio customers. The XZone4 is a 1U rack-mountable component offering four independent audio streams that support up to four rooms of audio in a home or business, and can easily scale up to 16 total audio zones by linking up one or more of the other XStream series products.

RSXZONE4	Four-Stream, Four-Zone Audio System	1,215.76
----------	-------------------------------------	----------

Products Coming Soon

Coming in Summer, 2018

The summer of 2018 will see the launch of Russound's next generation of streaming audio products including:

- MBX-PRE streaming audio player, with built-in Wi-Fi support, 12v trigger, and full digital/analog inputs/outputs.
- MBX-AMP, a Wi-Fi equipped Zone player with TV audio integration for automatic switching between multi-room and local TV sound.
- The XTS Plus advanced Android in-wall touchscreen will add a larger screen, advanced POE power supply and new software options for expanded system flexibility. Pricing and details to be announced as soon as available.

User Interfaces

Russound XTS Touchscreen

- 4.7" (11.9 cm) High Resolution Quad HD Display
- Horizontal or Vertical Orientation Mounting
- Runs MyRussound™ App
- Powerful Cortex-A9 Processor
- Supports all MCA-series controllers, Russound streaming sources and the new Russound 70V amplifier
- Controls any zone in a supported Russound system
- Gigabit Ethernet, with 802.3af POE



RSXTS

XTS Touchscreen Interface

RSXTS	Touchscreen for the MCA series controllers, X-Zone4 controllers, X-Source streamers, and Russound 70V	404.56
-------	-------------------------------------------------------------------------------------------------------	--------

MCA Keypads and Remotes

RSMDK-C6	2-gang keypad for use with the MCA controllers, White	217.36
RSSLK-1	Single-gang keypad for use with the MCA controllers, White	161.20
RSUSRC	Universal/Learning Remote for use with all Russound keypads and controllers	30.16
RS2500-521065	Advanced Programming cable for KP4, KP6, KPL, ISK1, ISK2, ISK3, ISH1	13.10



RSSLK-1

RSMDK-C6



RSUSRC

RSBTC-1X



RSBSK1

MCA and RNET Sources

RSBTC-1X	External Bluetooth Receiver for MCA-66, MCA-88, and MCA-88X with Bluetooth port	79.01
RSST1	RNET-enabled Tuner with RDS Support. 1/2 rack width, Compatible with MCA & C-Series controllers.	218.40
RSBSK1	RNET-enabled 2 piece Bluetooth interface for MCA systems	134.16

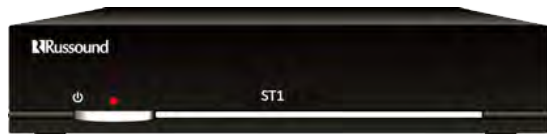

RSST1

Russound Certified Installer Program

The Russound Certified Installer (RCI) Program is designed to provide the best possible product and installation experience to consumers while maximizing the value that the thousands of Russound installers in the US and around the world offer to their customers throughout the sale and installation process. With the RCI Program, Russound guarantees that a dedicated Russound Certified Installer is fully involved in the installation process of Russound products.

The controllers are shipped "locked" and can only be unlocked using the password of a Russound Certified Installer. For this reason, they cannot be sold on the internet. This protects dealer pricing and the integrity of the Russound brand.



Digital Media Streamer



RSXSOURCE

The XSource Streaming Audio Player is a multi-use streaming media solution with a tiny form factor for easy integration with external amplifiers or whole-house receivers.

Designed for scalability, the XSource includes native support for high resolution audio and the full complement of sources available in all of Russound's XStream series of products. The XSource also supports playback from connected USB storage devices.

XSource can be integrated with other XStream series components, Russound MCA-Series and C-Series controllers, or can operate as a stand-alone streaming source that can be used alongside any amplifier or multiroom audio system. It offers both analog and digital outputs as well as built-in Ethernet connectivity. The innovative built-in clip allows the physical coupling of multiple units. Couple four units together to fit a standard 17" rack width.

Use as a source for MCA-series, C-series, CAV, CAM, CAA, and stand-alone amplifiers. Uses are limited by your imagination.

RSXSOURCE	XSource Streaming Audio Player	255.84
-----------	--------------------------------	--------



MCA-88 8-Zone Whole House Audio

RSMCA-88 Front



RSMCA-88 Back

Features:

- Expansion for MCA-88X system or stand-alone
- 8 zones: 40W/Ch zones 1-6, zones 7 and 8 line out only
- Fixed / variable line out for all 8 zones
- 6 amplified zones @40 wpc
- 8 analog inputs / 3 digital coax inputs / 1 optical input
- Input 8 can be reassigned as an auto-sensing page
- Source loop outputs for all sources
- 6 routed IR outputs plus a global IR out
- Built-in IR learner and library IR codes
- RS232 and IP controllable
- Global 12v trigger in/out
- Programming software is a free download
- Programming and updates via USB port or Ethernet
- Zone Linking locks multiple zones together for all functionality
- Source Linking ensures selected zones always play the same source
- Source Mapping allows sources to only be available in selected zones
- Audiophile quality DACs support high resolution audio (24 bit/192kHz)
- Adjustable bass, treble, balance and loudness
- Connection for optional BTC-1X Bluetooth transceiver
- Rackmountable
- Expandable to up to 48 zones
- Compatible with Leviton OmniPro II

Double Warranty with Russound Speakers! See p.154



RSKT2-88	MCA-88, (6) white MDK-C6 keypads, remote, (8) 845.1 emitters, rack ears	2,838.16
RSMCA-88	8-source audio input, 8-zone audio output with 40W/Ch (zones 1-6, line out 7-8), routed IR, RS-232, paging, rack ears	1,638.00
RSBTC-1X	External Bluetooth receiver using Bluetooth port	79.01

MCA-66 6-Zone Whole House Audio



RSMCA-66 Front



RSMCA-66 Back

Features:

- Fixed / variable line out for Zone 1 and 2
- 6 amplified zones @20 wpc
- 6 analog inputs / 3 digital coax inputs / 1 optical input
- Connection for optional BTC-1X Bluetooth transceiver
- RS232 and IP controllable
- 6 routed IR outputs plus a global IR out
- Built-in IR learner and library IR codes
- RS232 and IP controllable
- Global 12v trigger in/out
- Programming software is a free download
- Programming and updates via USB port or Ethernet
- Zone Linking locks multiple zones together for all functionality
- Source Linking ensures selected zones always play the same source
- Source Mapping allows sources to only be available in selected zones
- Audiophile quality DACs support high resolution audio (24 bit/192kHz)
- Adjustable bass, treble, balance and loudness
- Rackmountable
- Expandable to up to 36 zones

Double Warranty with Russound Speakers! See p.154



RSKT2-66	MCA-66, (6) white MDK-C6 keypads, remote, (6) 845.1 emitters, rack ears	2,078.96
RSMCA-66	6-source audio input, 6-zone audio output with 20W/Ch, routed IR, RS-232, paging, power management, rack ears	1,194.96
RSBTC-1X	External Bluetooth receiver using Bluetooth port	79.01

The MCA-66 and MCA-88 also support Bluetooth streaming through an optional external receiver, the BTC-1X.



RSBTC-1X

The A-BUS system from Russound has long been known as the easiest distributed audio system to install due to its simplified wiring structure. That's why the installation professionals love it. But why do they keep recommending it? Because their customers love it, of course!

A-BUS Amplified Volume Control Keypads and Accessories



RSA-K4

Amplified Keypads		
RSA-K4	A-BUS amplified keypad with IR receiver, pre-amp output, system status, 1 through 4 source selection depending on hub specifications, white.	106.92

Local Source Modules		
RSA-LC3	A-BUS local source input with IR emitter output, auto sensing to override audio on source one, white.	73.44
RSBTA-2	Bluetooth enabled local source module for A-BUS systems, override audio on source one, white.	85.32

- A huge benefit of A-BUS is the Local Source feature
- Local Source allows a customer access to "whole house" sources connected at the hub as well as audio sources in the room
- Local source is great for portable media (iPhone, iPod, iPad, Android) as well as media in the room such as televisions and media streamers



RSA-LC3

- Wire in between the A-BUS hub and the volume control
- When audio is sensed on the front RCA jacks, the module will automatically switch from the main source to the local source. When audio is removed, the module will return to the audio provided by the hub.
- Adjustments for switching sensitivity and delay
- Infrared emitter port allows control of the local source via infrared repeating

RSBTA-2

- Bluetooth local source module for A-BUS systems and subzones
- Acts like an A-LC3 but uses Bluetooth instead of analog RCA inputs to receive audio from a personal music player, smart-phone, tablet or PC
- Stream Bluetooth audio from up to 15 meters away
- Custom naming for easy identification
- Bluetooth 2.1 and EDR/Class 1 with A2DP Profile

A-BUS Hubs / Source

RSA-H4D-*	In-wall single-source 4-zone hub, double-gang work box, (4) IR emitter jacks, requires A-PS	106.92
RSA-H484	Surface-mount 4-source, 4-zone hub, (4) routed IR emitter jacks, (1) common IR jack, 12V trigger	333.72
RSA-H4	Surface-mount single-source, 4-zone hub, (4) IR emitter jacks, IR link input/output, confirmation LED	122.04
RSA-H2	Surface-mount single-source, 2-zone hub, (4) IR emitter jacks, IR confirmation LED	88.56
RSA-PS	A-BUS power supply, 24VDC, detachable power cord, provides clean and regulated power	91.80

(*W-White and Almond, B-Bone, BL-Black, BR-Brown)



RSA-H4D



RSA-H4

Look on pages 209 through 215 for Rough-in Boxes, Tools, and Cable

Using A-BUS on an MCA-Series System

Add rooms to an MCA-series without purchasing additional controllers

How many times are you designing a system only to find you need 1 or 2 extra rooms? Instead of eliminating the zones or purchasing another controller, there is a less expensive solution: A-BUS subzoning. Simply add an A-BUS Hub and wire CAT-5 to an A-BUS keypad. The keypad gives separate on/off/volume, yet plays the same source audio as the primary zone. Responds to All On/Off and Page events as configured for the primary zone. The sub-zone will support a local source by adding an RSA-LC3.

RSA-H2	Surface-mount single-source, 2-zone hub, (4) IR emitter jacks	88.56
RSA-PS	Power Supply required for A-bus hub	91.80
RSA-K4	A-BUS LCD amplified keypad with IR receiver	106.92
RSA-LC3	A-BUS local source input with auto sensing	73.44

Primary zone must be on for sub-zones to operate

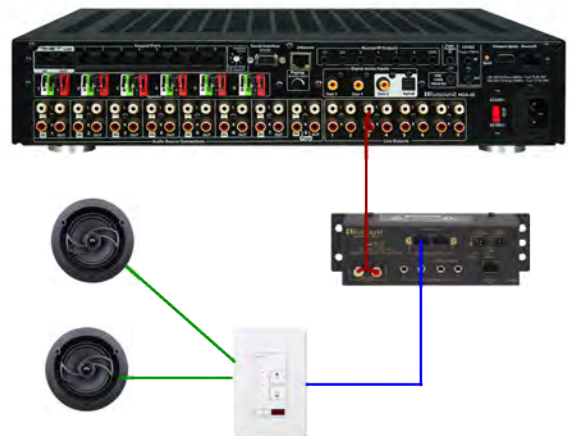

CAA66 Multi-Source / Multi-Zone Audio System



Features:

- 6 audio inputs
- 6 zones with 40W per zone
- Serial port
- IR library and learning IR
- Routed IR source selection
- 12VDC mute input, trigger output
- Preamp or fixed output zones (1/2)
- Bass, treble, and loudness control
- Link 6 CAA66s for a 6x36 system
- Compatible with Leviton OmniPro II

Double Warranty with Russound Speakers! See p.154

LEVITON connectivity partner

OmniPro II AUTOMATION

RSCAA66	6-source input, 6-zone output with 40W per zone, serial port, routed IR, mute in, trigger output, fixed or variable preamp outputs for zones 1 and 2, controller link, punchdown tool	851.76
RSCAA66L-W	CAA66, (6) white KPL keypads, remote, (6) 845.1 IR emitters, rack ears	1,382.16
RSCAA66K-W	CAA66, (6) white KP6 keypads, remote, (6) 845.1 IR emitters, rack ears	1,122.16
RSUSRC	Universal Systems Remote for use with all Russound systems	30.16
RSKPL-W	Single-gang LCD keypad for CAA66 controllers	154.96
RSKP6-W	Single-gang 6-source keypad for CAA66 controllers	82.16
RSKPSC-W	Source control keypad for CAA66 controllers, works with KP6 and KPL	40.56

White and Almond included



RSKP6

CA-4 Multi-Source / Multi-Zone Audio System (non-A-BUS)



RSCA4-KP



RSCA4

Features:

- 4 audio inputs
- 4 zones with 30W per zone
- Use 2 systems for an 8-zone system
- Party mode on command
- Command for All Zones Off
- Source grouping
- Bass, treble, loudness control
- Serial port
- 12VDC mute input, trigger output
- Keypad/speaker connection plate
- Compatible with Leviton OmniPro II one-way communication

Double Warranty with Russound Speakers! See p.154

LEVITON connectivity partner

OmniPro II AUTOMATION

RSCA4-KT1	CA4 controller, (4) CA4-KP keypads, CA4-WP wallplate, remote, (4) 845.1 emitters, rack ears	612.56
RSCA-4	4-source input, 4-zone output with 30 watts per zone, RS-232 (1-Way Leviton communication), routed IR, rack ears	435.76
RSCA4-WP	Single-gang in-wall connection plate for the CA4 system. 4 RJ-45 inputs, 4 RJ-45 outputs, and 4 pair of speakers	36.40
RSCA4-KP	Single-gang keypad for the CA4	61.36
RSUSRC	Universal Systems Remote for use with all Russound systems	30.16

Russound Wallplate and Box Solutions

RSHTP-7.2	Home Theater 2-gang decorator wall-plate, speaker binding posts for 5.1, 6.1 and 7.1, (2) "F" connectors, (2) RCAs for subs	33.28
RSWPB37-23	Vertical self-closing cover with 3/8" gasket and 2 mounting screws	14.46
RSWPB37-23FS	Same as above, mounts to flat surface w/ 4 screws	16.33
WAVAC1602RWH15	16/2 Speaker Wire , Strand CMR 500' Box White	66.20



RSHTP-2

CasaTunes Streamer

CasaTunes offers music streamers designed to supply streams to and control of RTI, Audio Authority, Channel Vision, Nuvo, Russound, and SpeakerCraft multi-room systems. This allows you to provide audio streaming and control of Russound CAV, CAA, and CA-4 systems from the CasaTunes app.

CasaTunes®

CASCT-1	Single Stream Server, Includes cables for Russound integration	389.00
CASCT-2	Two Stream Server, Includes cables for Russound integration	520.00



70-Volt Commercial Audio Amplifier with Built-in Media Streaming

The Russound XZone70V features built-in XStream technology, enabling popular streaming content from the cloud, home network, AirPlay™ enabled tablets, and phones - all from a single component. The built-in audio streamer offers the best audio content from the internet or even a user's personal networked audio collection using DLNA. The rear panel even includes a USB port for playing content from a Flash Drive or an externally powered USB hard drive.

- 70v/100v/4Ω operation - Powerful 300W output - Controllable by the XTS Touchscreen or the MyRussound App - 3.5mm auxiliary audio input
- XStream™ complement of streaming sources including: SiriusXM for Business, Spotify, Pandora, AirPlay and more
- Mix and match with other XStream Series components for versatile system designs
- USB Port for flash-based or hard drive audio
- Mic Input with phantom power support



RSXZONE70V	70V 300 Watt Streaming Mixing Amplifier with Mic input	743.60
RSAW70V6B	70V surface-mount Indoor/Outdoor Speaker, 70V: 7.5W, 15W, 30W, 60W, 6 Ohm - Black	248.56
RSAW70V6W	70V surface-mount Indoor/Outdoor Speaker, 70V: 7.5W, 15W, 30W, 60W, 6 Ohm - White	248.56
RSALT-70V-50	70V 50 Watt Volume Control - White	23.40



High Resolution Digital Amplifiers

RSTVA2.1	2-channel TV amplifier with sub out, 35w@ 4Ω, IR learning, digital in, designed for flat panel TVs	171.60
RSD250-LS	1-zone/2-channel amplifier, auto A/B amplified switching capabilities, 12VDC in/out, video sensing, line-level or speaker-level switching, 50W/Ch @ 8Ω (75W/CH @ 4Ω), bridgeable to 140W @ 8Ω, gain control. Includes surface/rack mounting hardware.	206.96
RSD850	8-channel amplifier: 35w@8Ω, 50w@4Ω, bridgeable to 100w, 12VDC input and output trigger, auto signal-sensing, separate gain controls, thermal and short protection, rack ears, bus input-output	622.96
RSD1650	16-Channel Amplifier 50w@8Ω, 80w@4Ω, bridgeable to 160w, global and zone input trigger auto signal-sensing, separate gain controls, thermal and short protection, rack ears	1,038.96



RSTVA2.1

Amplifier Features	TVA2.1	P75	P125	D250-LS	D850	D1650	A250	A2100
Total channels	2	2	2	2	8	16	2	2
Auto signal sensing inputs	Y	Y	Y	Y	Y	Y	Y	Y
Separate channel gain controls	-	-	Y	Y	Y	Y	-	-
Short-circuit protection	Y	Y	Y	Y	Y	Y	-	-
Rack mount ears included	N/A	N/A	N/A	Y	Y	Y	-	-
12-volt trigger input and output	-	-	Y	Y	Y	Y	Y	Y
Bus input and output	-	-	N	-	Y	Y	-	-
Source loop outputs	-	Y	Y	-	-	-	Y	Y
Local source switching	-	Y	Y	Y	-	-	-	-
Front panel controls	-	Y	Y	-	-	-	-	-



RSD250-LS



RSP75



RSD850



RSD1650

Integration Amplifiers

RSP75	2-channel amplifier, 60w@8Ω, 75w@4Ω, bridged mono 160w@8Ω, auto signal-sensing source selection, thermal and short protection, local source switching, front panel controls	103.99
RSP125	2-channel amplifier, 80w@8Ω, 125w@4Ω, bridged mono 250w@8Ω, 12VDC input and output trigger, auto signal-sensing source selection, separate gain controls, thermal and short protection, local source switching, front panel controls	321.36
RSA2100	2-channel amplifier, 100w@ 8Ω, bridged mono 200w@8Ω, 12VDC input trigger, auto signal-sensing	248.56



RSP125



RSA2100



Change from a ceiling speaker to a wall speaker by changing the grille



Say goodbye to crooked in-wall installations, simply rotate the grille until it is level!

Double the warranty on your Russound controllers by using Russound speakers.

Acclaim Edgeless Speakers

RSRSF-610	Edgeless 2-way speaker: 6.5" Poly woofer, ¾" pivoting PEI tweeter, 5 - 120 watts, pair	57.20
RSRSF-610T	Edgeless single-point stereo: 6.5" IMPP Ribbed woofer, two tweeters, 5 - 150 watts, each	50.96
RSRSF-620	Edgeless 2-way speaker: 6.5" Poly woofer, 1" pivoting Silk tweeter, 5 - 150 watts, pair	92.56
RSRSF-820	2-way speaker: 8" Poly woofer, 1" pivoting Silk tweeter, 5 - 150 watts, pair	123.76

Acclaim Angled Edgeless Speakers

RSRSA-635	2-way 15° angled speaker: 6.5" IMPP woofer, 1" pivoting Teteron tweeter, 5 - 150 watts, each	134.16
-----------	----------------------------------------------------------------------------------------------	--------

Acclaim Edgeless Speaker Grilles

RSRSG-6RW	Replacement round speaker grilles for Russound RSA-6 model speakers - white	9.36
RSRSG-6SW	Square speaker grilles for in-wall Russound RSA-6 and RSF-6 speaker installations - white	9.36
RSRSG-8RW	Replacement round speaker grilles for Russound RSA-8 and RSF-8 model speakers - white	9.36
RSRSG-8SW	Square speaker grilles for in-wall Russound RSA-8 and RSF-8 speaker installations - white	9.36

Limited Lifetime Warranty on Indoor Speakers

Acclaim Edgeless Speaker Rough-In Brackets

RSSB-C67	Rough-in bracket for Acclaim 6½" Edgeless speakers, Pair	Pair 15.60
RSSB-C80	Rough-in bracket for Acclaim 8" Edgeless speakers, Pair	Pair 15.60

High-Performance Landscape Speaker System

The AW4-LS-BR loudspeaker offers an elegant, scalable platform for providing high quality audio to any outdoor area in even the harshest environmental conditions. Specially designed to withstand both extreme heat and cold, the speakers work great from the humid, hot conditions of summertime in Florida to the bone-chilling cold of a Minnesota winter.

The AW10-LSUB-BR is designed to add enhanced low frequency response to any outdoor audio system. While designed to be paired with our AW4-LS-BR landscape satellite loudspeaker, the unobtrusive design of the sub after installation means that this powerful subwoofer can be easily added to any outdoor audio system.

RSAW4-LS-BR	2-Way Outdoor Loudspeaker, 8ohm/70v/100v capable (each)	145.08
RSAW10-LSUB-BR	10" Outdoor Below-Ground Subwoofer, 8ohm/70v/100v capable	585.00
RSXZONE70V	70V, 300Watt amplifier with XSource streamer	743.60
RSD850	8-channel amplifier: 35w@8Ω, 50w@4Ω, bridgeable to 100w, 12VDC input and output trigger, auto signal-sensing, separate gain controls, thermal and short protection, rack ears, bus input-output	622.96



Acclaim 5 OutBack™ Outdoor Speakers (Weather Resistant)



The Acclaim 5 Outback speakers provide a unique mounting system. Each speaker includes a foot for bookshelf applications and a tapered bracket that allows wall, corner, or pole mounting.

RS5B45*	Indoor/outdoor: 4" polypropylene cone, 1" Teteron™ tweeter, power handling from 10 - 100 watts, 8Ω, pair	102.96
RS5B55*	Indoor/outdoor: 5.25" polypropylene cone, 1" Teteron™ tweeter, power handling from 10 - 125 watts, 8Ω, pair	135.20
RS5B65*	Indoor/outdoor: 6.5" polypropylene cone, 1" Teteron™ tweeter, power handling from 10 - 150 watts, 8Ω, pair	182.00
RS5B65S*	Single-point stereo indoor/outdoor: 6.5" injection-molded polypropylene cone, (2) 1" Teteron™ tweeters, multiple mounting options, power handling from 10 - 150 watts, 8Ω, pair	130.00

(*W-White, BL-Black)

OutBack™ Rock Speakers

RS5R82-G	8" 2-way Outdoor Rock Speaker: Gray Granite - each	123.76
RS5R82-S	8" 2-way Outdoor Rock Speaker: Sandstone - each	123.76
RS5R82-W	8" 2-way Outdoor Rock Speaker: Weathered Granite - each	123.76



ALTx Series 1x, 2x, 4x, 8x Autoformer Impedance Matching Volume Controls - 126W

RSALT-126R	Decorator plate and knob, 126W stereo impedance matching volume control, 12 steps of attenuation, detachable 12-gauge connector, lifetime warranty. White and Light Almond included. Color change kits available separately (Almond, Black, Bone, Brown)	20.79
RSWALTX-2	Weatherproof plate and knob, 126W stereo impedance matching volume control, fits a standard 3/4" PVC outdoor conduit, gray	70.51
RSTBL-75	Tabletop, 126W stereo 1x, 2x, 4x, 8x selectable impedance matching volume control w/ headphone jack speaker override	78.62
RSEZB-8	EZ-connect speaker terminal block, 1 amplifier input, 8-pair speaker outputs, 14-gauge snap connector	30.16

Impedance Matching Volume Controls: A Great Value

In today's high tech digital world, sometimes we overlook the simple solutions. What can be simpler to offer, specify, or install than impedance matching volume controls?

Turn it on, off, up or down. Russound volume controls allow customers to enjoy the music anywhere in their home. Russound is known for their autoformer impedance matching technology, long term reliability, and lifetime warranty.

Start with an amplifier (page xxx). For background audio throughout the home budget 20 watts per channel (8Ωs) per room. Choose if you want to use a speaker switcher (below) and the appropriate volume controls. If a speaker switcher is not being used consider using the EZB-8 distribution block for a clean installation.



RSEZB-8



RSALT-126R

Single Source Resistor-Based Speaker Selectors



RSSS-6.2

RSSS-4.2	4-pair speaker selector, 100W/Ch RMS, for use with 4Ω stable amplifiers	67.60
RSSS-6.2	6-pair speaker selector, 70W/Ch RMS, for use with 4Ω stable amplifiers	92.56

A/B Speaker Selectors



RSAB-3.2



RSAB-1.2*	Decorator style in-wall A/B speaker/amplifier selector (*W-White, LA-Light Almond, A-Almond, B-Bone, BL-Black, BR-Brown)	25.00
RSAB-2.2	Freestanding manual A/B speaker/amplifier selector	46.80
RSAB-3.2	Auto A/B speaker level switching, selectable delay and sensitivity, 110VAC	78.00

Occasionally, the question comes up: "How do I get the sound from my C-series controller into the home theater?" You can share one pair of speakers using the RSAB-3.2. When the theater is off, the C-series can take over the speakers. You can use a keypad or the MyRussound app to control the C-Series controller.

Autoformer-Based Speaker Selectors with UltraMatch™ Volume Controls



RSSDB-4.1

RSSDB-4.1	4-pair speaker selector with UltraMatch™ Volume Controls, 2x, 4x, 8x impedance settings, 200w/Ch RMS, detachable 14-gauge color-coded snap connectors, zone identifying labels	248.56
-----------	--------------------------------------------------------------------------------------------------------------------------------------------------------------------------------	--------

Autoformer-Based Speaker Selectors



RSPRO-6HP



RSPRO-12HP

RSPRO-6HP	6-pair speaker selector with adjustable impedance matching, 100W/Ch RMS w/ subsonic filter built in, detachable 14-gauge color-coded snap connectors, zone identifying labels	213.20
RSPRO-8HP	8-pair speaker selector with adjustable impedance matching, 200W/Ch RMS w/ subsonic filter built in, detachable 14-gauge color-coded snap connectors, zone identifying labels	244.40
RSPRO-12HP	12-pair speaker selector with adjustable impedance matching, 200W/Ch RMS w/ subsonic filter built in, detachable 14-gauge color-coded snap connectors, zone identifying labels	290.16

Speaker Wire

WAVAC1202RWH2	12/2 Audio Cable: 12AWG, 2C 65 strand oxygen free copper	CMR	(White)	500' Pull Box	157.37
WAVAC1402RWH15	14/2 Audio Cable: 14AWG, 2C 105 strand oxygen free copper	CMR	(White)	500' Pull Box	99.92
WAVAC1402RBL15	14/4 Audio Cable: 14AWG, 4C 105 strand oxygen free copper	CMR	(BL-Blue)	500' Pull Box	99.92
WAVAC1402OSPBK1	14/2 Direct Burial Audio cable, 2C 65 strand oxygen free copper	CM	(Black)	500' Pull Box	106.16
WAVAC1602RWH15	16/2 Audio Cable: 16AWG, 2C 65 strand oxygen free copper	CMR	(White)	500' Pull Box	66.20
WAVAC1604R**15	16/4 Audio Cable: 16AWG, 4C 65 strand oxygen free copper	CMR	(BK-Black, WH-White)	500' Pull Box	122.40

Russound SaphIR Infrared



RSSLM-1K	Universal Surface Mount IR Kit: (1) SLM-1 Slim receiver, (1) CB-140 connecting block, (4) IRE-1 emitters	35.36
RSSLM-1	Slim design surface-mount universal IR receiver (LED, LCD, Plasma, CFL)	25.97
RSCB-140	Compact IR connecting block, (1) receiver input, (4) emitter outputs	18.18
RSIRE-1	Low profile IR emitter	5.19

- Many custom audio-video systems use infrared commands to operate source equipment. But Infrared commands cannot pass through walls or cabinet doors
- Russound's SaphIR® infrared repeating products allow installers to place audio/video products in locations that are aesthetically pleasing or more convenient
- Use an infrared receiver to capture a command, a distribution block to inject power and an emitter to issue the command to the audio/video component
- For shorter distances, use the supplied cables; for longer distances, Category 5 cable works great
- Blue signal confirmation LED allows customers to visually confirm that an infrared command has been received

HomeTheater Wall Plate

RSHTP-7.2	Home Theater Wallplate, White	33.28
-----------	-------------------------------	-------

- o Simplify wiring connections in any home theater installation, from a simple 5.1 system up to a 7.2 system
- o No solder connections - plug-and-play on both sides of the plate
- o Gold-plated connectors
- o 2-gang Decora format, each half can be used individually as a 1-gang option
- o Color-coded 5-way binding posts for easy wiring every time

A11LVA2	2-Gang Adjustable Depth Mounting Brackets	2.66
---------	-------------------------------------------	------



ComPoint Intercom

ComPoint™ The Music Lover's Intercom Solution



RSISK3-AB



RSISSP



RSISK2-W

RSISK2 Advanced Keypad:

- LCD with assignable descriptions
- Volume Control and Do Not Disturb
- Integrated 50 W/CH relay allows sharing speakers with whole house audio
- Integrated paging amplifier and microphone
- Selectable amber or green backlighting



RSISH1

RSISH1	System hub, (6) intercom zones, (2) door stations, (7) chimes, link 6 hubs for 36 stations, requires RSISPS	227.76
RSISPS	ComPoint power supply	42.12
RSISK2-W	Advanced LCD ComPoint keypad, assignable zone names, White only	182.52
RSISK3-AB	Weatherproof door station, plated die-cast zinc. Antique Brass finish.	135.00

ComPoint products are sold individually. Kits are no longer available.

ComPoint Accessories

RSISSP	Single-gang speaker for ComPoint, White and Almond included	21.60
RS2500-521065	Advanced programming cable for KP4, KP6, KPL, ISK1, ISK2, ISK3, ISH1, MDK-C5 and BGK1	13.10
RSISDR1	Door strike release module, NO and NC contacts, relay rated for 1A @ 12VDC	52.92



RSISDR1

Single-Gang Boxes

A11LV1	Low-voltage mounting bracket, old work, single gang, plastic, adj. ¼" - 1" walls	0.93
A11LV2	Low-voltage mounting bracket, old work, double gang, plastic, adj. ¼" - 1" walls	1.40
A11LV3	Low-voltage mounting bracket, old work, 3-gang, plastic, adj. ¼" - 1" walls	2.37
A11LVMB1	Low-voltage mounting bracket, new construction, single gang, plastic	0.78
A11LVMB2	Low-voltage mounting bracket, new construction, double gang, plastic	1.34

Why use IR?

In some situations, especially in larger AV installations, there are components that are buried in a rack or in an equipment room, but these devices need to receive IR commands to work properly. With Xantech IR devices, we can get those transmissions from your home theater or living space to the equipment room or rack. With this technology, we can control any AV equipment with the press of a button!

Designer Infrared Emitters



			10-pk	5-pk	Each
X282D	Standard designer emitter, non-visible, 10' cable		74.32	N/A	9.62
X282TPD	Twin plug mini designer emitter, dual plug - single emitter		N/A	N/A	9.62
X283D	Mini blink-IR designer emitter, visible, low-output version, 10' cable		74.32	38.47	9.62
X283TPD	Twin plug mini blink-IR designer emitter, dual plug - single emitter		N/A	N/A	9.62
X284D	Dual mini emitter, non-visible, wire is 7' to junction, 3' to each emitter		83.06	N/A	10.49
X286D	Dual blink-IR emitter, visible, wire is 7' to junction, 3' to each emitter		91.80	N/A	10.49
X28DES	Designer emitter shield cover, use to block interference		N/A	N/A	2.62

Power Supplies



XPS12-0.5	Regulated 12VDC power supply, powers basic Xantech IR systems, uses 2.1mm coax plug				9.89
X782ERGPS	12VDC high-current power supply, powers large Xantech IR systems, uses 2.1mm coax plug				9.89

Modules

XCBCSM1	Current sensor connecting block, requires CSM1 and 781ERGPS power supply				28.85
XCSM1	Current sensing module, requires CBCSM1 and 781ERGPS for stand-alone operation				56.39

Programming and Controllers

XRC68X	IR remote programmer, use to program universal learning devices, req. 2 AA batteries (See below)	89.93
XISM4	The ISM4 eliminates the need for multiple remote controls. Simply walk up and press the power button on one of the devices. Automatic status control of up to 4 devices, 4 IR ports, 4 sensor inputs, bi-directional RS-232 port for status, can be used with all Xantech sensor modules, IR pass-through, XPS programming feature allows for programming without a PC. Includes power supply and (1) video sensor.	209.83
UBD5312	Alkaline AA Batteries. Sold in 2packs.	0.80



Cables and Volume Control Accessories

X784-00	50' emitter extension cable w/ 3.5mm plug & jack on opposite ends, also works for IR receivers	5.40
X05913778	Programming cable: RS-232 to keypad	5.25
X6017400	1' mono cable - 3.5mm / 3.5mm plug, used to create a direct connection to devices	2.19
XXVCD100	100W rotary impedance matching volume control, decorator style	39.57



X784-00

Remote Control Switchers

X680-10	Remote AC switcher, 6 AC receptacles rated at 5A each, 15A total, outlets controlled individually or as a group, requires RC68X hand-held programmer	244.80
XAC1	Controlled AC outlet, maximum switching current: 15A continuous @ 120VAC	73.74
XCC12	Remote relay module, 1 DPDT relay rated at 5A, 30VDC, 2 normally open & 2 normally closed contacts, requires power supply and RC68X	89.93
XRT8	1x8 addressable IR router, requires power supply & RC68X	151.08
XRT16-10	1x16 addressable IR router, requires power supply & RC68X	236.06
XRP41AV	IR remote control A/V pre-amplifier w/ power supply, requires RC68X	187.97



XRT8



XRP41AV



XCC12

CasaTunes Internet Music Streamers



CasaTunes focuses on the design of multi-room music servers. CasaTunes is the ideal solution for 3 rooms or as many as 24. This is what customers will typically interact with every time they want to listen to their music. It has to be simple, reliable and, well, fun!



...and more

Alexa Voice Control



CasaTunes has developed an Alexa Skill which can be used with various Alexa enabled products to allow you to control CasaTunes using your voice.

For CasaTunes specific control, we recommend using an Echo Dot in each room where you would like to control CasaTunes using your voice. The Echo Dot provides all the capabilities required by CasaTunes, and is value priced.

App Control - More than just song selection!

The CasaTunes app gives you the ability to not only control the sources you are using but it will also give you full control of your zones as well. What that means is that you will be able to adjust the volume and source on any zone as long as you are on the same wifi network.

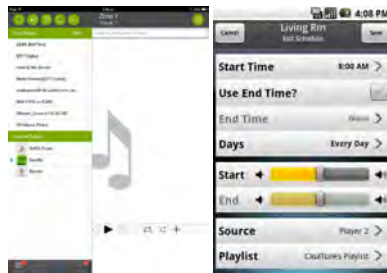

OmniTouch 7 Integration

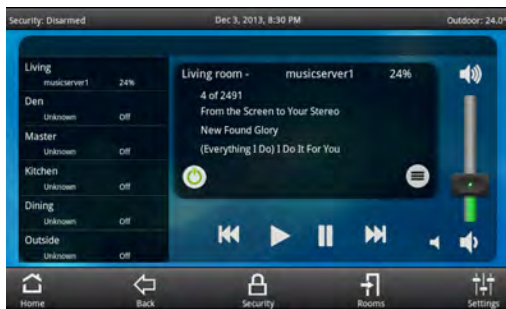

CasaTunes provides meta-data on the OLED VSC keypads and OmniTouch 7. Set up takes just minutes and configures the Leviton Hi-Fi 2 for you!



CASCT-1 and CASCT-2



CASCT-3S



The CasaTunes Streamers supply 3 to 8 sources of streaming music to your existing system. Each stream can be your iTunes or Windows Media songs, streams from internet music services, audio from uPnP/DLNA media servers, even music sent to CasaTunes via AirPlay from your iPad or iPhone.

CASCT-1	One-stream controller	389.00
CASCT-2	Two-stream controller	520.00
CASCT-3S	Three-stream controller	750.00
CASCT-4S	Four-stream controller	1,050.00
CASCT-8S	Eight-stream controller	1,395.00

Works with these great systems and more!



And many more....

CasaTunes is a great reason to contact any customer that might have an aging whole-home music system. The CasaTunes streamers allow a simple upgrade path to take a dated system and add modern app and streaming control. New or legacy whole home audio systems like the Russound CAV6.6 are perfect for integration with any of the CasaTunes streamers. Integration is via serial or network depending on the system.

Suggested Controllers

With the Leviton Hi-fi 2 controllers paired with a CasaTunes music streamer, you will gain full control of your zones and sources within the CasaTunes app.

The CasaTunes controllers also have the ability to push Metadata to the Hi-fi2 keypads.



The CasaTunes music streamers will work wonderfully with the Russound series of amplifiers. The music streamers listed above would be a perfect compliment to the Russound amplifiers listed below.



The CasaTunes products will also work with any Russound legacy products including the CAV6.6 and others.

LSA95A00-1	Hi-Fi 2, 8 Zone-8 Source Kit in Enclosure	1,893.68
LSA95A00-2	Hi-Fi 2, 8 Zone-8 Source Kit on Backplate	1,893.68
LSA95A00-3	Hi-Fi 2, 4 Zone-4 Source Kit in Enclosure	946.75
LSA95A01-1	Hi-Fi 2, 4 Zone-4 Source board only	1,395.61

RSP75	2-Channel 75W Amplifier	103.99
RSP125	2-Channel 125W Amplifier	321.36
RSD850	8-Channel 50W per channel Amplifier	622.96
RSD1650	16-Channel 50W per channel Amplifier	1,038.96

Nuvo Player Portfolio



The Nuvo Touchscreen

The Nuvo P30 Touchscreen is a sleek, high contrast 7" Android 1024 x 600 IPS capacitive touch screen. This wall-mounted tablet runs the Nuvo Player app for complete management of all zones, sources, and audio functions. Power for the touchscreen is carried via a single PoE cable. A universal mounting plate for quick installation is included.

ONQNV-P30-BK	Nuvo P30 Touchscreen, black	199.84
ONQNV-P30-WH	Nuvo P30 Touchscreen, white	199.84



The Nuvo Tabletop Speaker

Stream music to any room with this all-in-one stereo speaker and amplifier, or easily expand an existing Player Portfolio system with an additional zone of audio. With a powerful 2.1 system, the P400 fills any room with rich, full-bodied sound, and stays perfectly in sync with other zones playing the same song. Blending premium performance with installation flexibility, the tabletop speaker makes it easier than ever to listen to the music you love.

ONQNV-P400-NA	Nuvo P400 Tabletop Speaker	455.88
---------------	----------------------------	--------



The Nuvo Sound Bar and Subwoofer

Merging the exceptional audio quality of Player Portfolio with dynamic home theater technology, the P500 delivers a cinematic experience that true audiophiles will love. With a powerful 2.1 system, complete with an 8" wireless subwoofer, the Sound Bar boosts listening experiences, playing movie, TV, or game audio in brilliant clarity. Better yet, the P500 is a single-zone Player Portfolio amplifier, granting access to networked music collections and endless streaming services. With convenient control options and simple setup, the Sound Bar delivers an immersive audio experience to complete any home theater.

ONQNV-P500-NA	Nuvo P500 Sound Bar and Subwoofer	624.50
---------------	-----------------------------------	--------



Nuvo Single-Zone Wired/Wireless Players

Introduce incredible audio into hard-to-wire spaces with Nuvo wireless single-zone players. Ideal for easily adding zones to an existing Player Portfolio System, single-zone players support both wired Ethernet or Wireless 802.11a/b/g/n configuration options for optimal flexibility. The P100 and P200 models both supply a speaker-level output at 40W and 120W, respectively. The P300 model has a pre-amp output.

ONQNV-P100NA	Nuvo P100 40W Player Amplifier	358.46
ONQNV-P200NA	Nuvo P200 120W Player Amplifier	449.64
ONQNV-P300NA	Nuvo P300 Player Preamplifier	299.76



Nuvo Professional Rack-Mount Multizone Players

Deliver a powerful experience with Nuvo's high-performing, professionally-installed multi-zone players. These sleek rack mount A/V units occupy 1U of rack space, but cover three listening zones for a clean installation with maximum efficiency. Hard-wire multiple players with Ethernet for centralized integration.

All models listed below include rack ears.

ONQNV-P3100NA	Nuvo P3100 3-Zone Player, 20W / Channel	1,042.92
ONQNV-P3500NA	Nuvo P3500 3-Zone Player, 50W / Channel	1,948.44
ONQNV-P4300NA	Nuvo P4300 3-Zone Player, 55W / Channel	1,311.45



ONQNV-P10-WH



ONQNV-P10-NI

Additional Nuvo Controls

ONQNV-P10-LA	Nuvo P10 Keypad, light almond	99.92
ONQNV-P10-NI	Nuvo P10 Keypad, nickel	99.92
ONQNV-P10-WH	Nuvo P10 Keypad, white	99.92

Scan the QR code for a pdf showing all Nuvo products with specifications.



Legrand also makes speakers for the Nuvo players. See page 195 for Nuvo speakers.

Speaker Selectors

Proficient speaker selectors are a great solution for whole house audio. With these simple devices you can distribute audio to free standing, in-wall, or in-ceiling speakers across your home.

PFSS4VC	Four-Pair Transformer-based on/off speaker selector with volume controls provides quick, convenient access for up to four stereo pairs. 60 watts power handling per channel.	245.00
PFSS8P	Eight-Pair Resistor-based on/off speaker selector provides quick, convenient access for up to eight stereo pairs. 125 watts of power handling per channel.	125.00
PFSS4P	Four-Pair resistor-based on/off speaker selector provides quick, convenient access for up to four stereo pairs. 125 watts power handling per channel.	70.00



PFSS4VC



PFSS4P

Volume Controls

PFVC60I*	60-watt impedance-balancing volume control with autoformer, quick & secure wire connecting system, fits in most single-gang J-boxes and plaster rings.	28.00
PFVC45I*	45-watt impedance-balancing volume control with autoformer, features removable wire block terminal for easy connection, fits in most single-gang J-boxes and plaster rings.	15.00
PFVCS60*	60-watt stereo volume control with autoformer, features quick & secure wire connecting system, fits in most single-gang J-boxes and plaster rings.	21.00
PFVC60SL*	60-watt slider stereo volume control with removable screw down wire terminal design, fits in most single-gang J-boxes and plaster rings.	33.00
PFVC60AW	60-watt weather-resistant volume control sealed against dust and moisture, fits onto 3/4" conduit or can be surface mounted, available in Gray	40.00

*Volume controls include white, bone and almond plates, inserts and knobs.



PFVC60I



PFVC60SL



PFVC60AW

Brackets and Back Boxes

PFPCB-IW500	One pair of pre-construction brackets, Fits 5-1/4" in-wall LCR speakers	20.00
PFPCB-C800	One pair of pre-construction brackets, Fits 8" ceiling, TT ceiling and ceiling LCR speakers	20.00
PFPCB-C600	One pair of pre-construction brackets, Fits 6-1/2" ceiling, TT ceiling and ceiling LCR speakers	20.00
PFPCB-C500	One pair pre-construction brackets, Fits 5-1/4" ceiling speakers	20.00
PFPCB-W800	One pair pre-construction brackets, Fits 8" In-wall speakers	20.00
PFPCB-W600	One pair pre-construction brackets, Fits 6 1/2" in-wall speakers	20.00
PFPCB-IW600	Pre-construction bracket for IW650 and IW625	20.00
PFBB-C800	Metal back box for 8" ceiling speakers, 8" single stereo speakers and 8" ceiling LCR speakers	50.00
PFBB-C650	Metal back box. Fits 6 1/2" ceiling speakers, single stereo ceiling speakers and ceiling LCR speakers.	50.00
PFBB-W600	Metal back box for 6 1/2" in-wall speakers	50.00
PFCTB-C600	Ceiling tile bracket. Fits 6 1/2" ceiling speakers, single stereo ceiling speakers and ceiling LCR speakers	16.00
PFCTB-C800	Ceiling tile bracket. Fits 8" ceiling speakers, single stereo ceiling speakers and ceiling LCR speakers	16.00
PFCMB-24	Mounting bars to attach BB-C650 to standard 24" ceiling joists, each	15.00

IR Devices

PFPAS80313	IR Shelf top kit, shelf top receiver, router, power supply, 4 IR flashers	85.00
PFPAS80315	IR Plasma kit, Plasma receiver, router, power supply, 4 IR flashers	135.00
PFPAS80311	IR Fisheye kit, fisheye hub, router, power supply, 4 IR flashers	120.00
PFPAS82200	IR router	30.00

PFPAS80315



Contains all components needed for 1-room system setup including:

- IR Plasma Receiver
- IR Router
- Power Supply
- 4 Single IR Flashers

PFPAS80313



Complete IR system including:

- Shelf-Top IR Receiver
- IR router
- Power Supply
- 4 Single IR Flashers

In-Ceiling LCR Speakers - priced each

PFC841	LCR, woofer & tweeter bridge fixed at 15°, 8" graphite woofer, 1" pivoting silk dome tweeter, +-3dB bass & treble contour switches, 150W	185.00
PFC661	LCR, woofer & tweeter bridge fixed at 15°, 6-1/2" graphite woofer, 1" pivoting silk dome tweeter, 125W	135.00
PFC656	LCR, woofer & tweeter bridge fixed at 15°, 6-1/2" graphite woofer, 1" pivoting silk dome tweeter, 100W	110.00
PFC651	LCR, woofer & tweeter bridge fixed at 15°, 6-1/2" polypropylene woofer, 1" pivoting silk dome tweeter, 100W	90.00



PFC841



PFC661



PFC651

In-Wall LCR Speakers - priced each

PFIW630	LCR, two 6 1/2" graphite woofers, 1" soft dome pivoting tweeter, bass/treble contour switch, 125W	200.00
PFIW530	LCR, two 5 1/4" graphite woofers, 1" aluminum pivoting tweeter, bass/treble contour switch, 100W	140.00



PFIW630



PFIW530

Cabinet Speakers

Using upward-firing drivers, the LDA5 Dolby Atmos-enabled speaker bounces sound off the ceiling, adding incredible envelopment and excitement to Dolby Atmos and DTS:X immersive soundtracks. It fits perfectly atop the Protege Cabinet Series LFS6 tower speaker and LB62 bookshelf speaker, and works with any AV receiver that has Dolby Atmos/DTS:X capability.



PFLDA5

PFLFS6	6" Floor Standing Speaker	225.00
PFLB62	6" Bookshelf Speaker	200.00
PFLB52	5" Bookshelf Speaker	160.00
PFLSB3	3-channel Passive Soundbar	300.00
PFLCRE5	Dual 5" LCR and Effect Speakers	140.00
PFLCRE4	Dual 4" LCR and Effect Speakers	100.00
PFLDA5	5" Dolby Atmos Speakers - Pair	150.00



PFLB62



PFLCRE5



PFLSB3

In-Ceiling Speakers - priced per pair

PFC801	8" graphite woofer, 1" aluminum pivoting tweeter, bass/treble contour switch, 150W	245.00
PFC791	8" polypropylene woofer, 1" soft dome pivoting tweeter, 125W	165.00
PFC641	6 1/2" graphite woofer, 1" aluminum pivoting tweeter, bass/treble contour switch, 125W	190.00
PFC626	6 1/2" graphite woofer, 1" silk dome pivoting tweeter, 100W	155.00
PFC635	6 1/2" aluminum woofer, 1" titanium dome pivoting tweeter, 100W	
PFC621	6 1/2" polypropylene woofer, 1" silk dome pivoting tweeter, 100W	130.00
PFC612	6 1/2" polypropylene woofer, 1" soft dome pivoting tweeter, 85W	105.00
PFC606	6 1/2" polypropylene woofer, 3/4" soft dome tweeter, 75W	85.00
PFC501	5 1/4" polypropylene woofer, 1/2" polyamide hard dome pivoting tweeter, 75W	95.00



PFC825TT



PFC791



PFC606

Single Point Speakers - priced each

PFC825TT	Single Point, 8" dual voice coil graphite woofer, twin 1" aluminum pivoting tweeter, bass/treble contour switch, 150W, each	135.00
PFC625TT	Single Point, 6 1/2" dual voice coil polypropylene woofer, twin 1/2" hard dome tweeter, 75W, each	80.00

In-Wall Speakers - priced per pair

PFW802	8" graphite woofer, 1" aluminum pivoting tweeter, bass/treble contour switch, 150W	240.00
PFW682	6 1/2" graphite woofer, 1" aluminum pivoting tweeter, bass/treble contour switch, 125W	200.00
PFW672	6 1/2" polypropylene woofer, 1" silk dome pivoting tweeter, bass/treble contour switch, 100W	150.00
PFW667	6 1/2" polypropylene woofer, 3/4" soft dome tweeter, 75W	95.00



PFW802



PFW672



PFW667

Red Hot Design. White Knuckle Performance.



A flagship product line built for the few, not the many. Its creation is free of restrictions that favor bottom line compromise ahead of top line performance. These considerations led us to produce the Proficient Signature Class.

It's Proficient's best of everything, an all star lineup featuring nine flagship speakers from home theater to whole house audio. Each speaker represents an unmatched combination of power, precision and performance.

Proficient Signature Class is all about qualities rarely seen working and playing well together in many other speaker brands. Like value and luxury. Innovation and tradition. Exuberance and poise.

The Proficient Signature Class is where sound performance you never thought possible becomes something you just can't live without. Experience the new Signature Class. Just what you would expect from Proficient.

PROFICIENT
Signature.

proficientaudio.com

Signature Series Speakers

There are few things in life that appeal to people more than a timeless design. And the new Proficient Signature Series fits right into that genre: a one-of-a-kind statement of power and performance that sits at the top of Proficient's line of loudspeakers.

PROFICIENT
Signature™

In-Ceiling Speakers - priced per pair

PFC895S	Signature 8" Ceiling Speakers, 8" Kevlar Woofers, 1" pivoting aluminum dome tweeters, 175 Watts, 8 Ohms impedance	285.00
PFC695S	Signature 6" Ceiling Speakers, 6-1/2" Kevlar Woofers, 1" pivoting aluminum dome tweeters, 150 Watts, 8 Ohms impedance	225.00



PFC895S



PFC695S

In-Ceiling LCR Speakers - priced each

PFC1075S	Signature 10" Ceiling LCR Speaker, Woofer & midrange/tweeter bridge fixed at 15°, 1" pivoting aluminum dome tweeter, 200 Watts, 4 Ohms impedance	300.00
PFC875S	Signature 8" Ceiling LCR Speaker, woofer & Tweeter bridge fixed at 15°, 1" pivoting aluminum dome tweeter, 175 Watt, 8 Ohms impedance	200.00
PFC675S	Signature 6-1/2" Ceiling LCR Speaker, Woofer and tweeter bridge fixed at 15°, 1" pivoting aluminum dome tweeter, 125 Watt, 8 Ohm impedance	150.00



PFC1075S



PFC875S



PFC675S

In-Wall LCR Speakers - priced each

PFIW675S	6-1/2" In-wall LCR Speaker, Two Kevlar woofers, 1" pivoting aluminum dome tweeter, 150 Watts, 8 Ohms impedance	240.00
PFIW575S	5-1/4" In-wall LCR speaker, Two Kevlar woofers, 1" pivoting aluminum dome tweeter, 125 Watts, 8 Ohms impedance	170.00

The IW675s is the audio equivalent of a big-block V-8 engine. It can go head-to-head with any home theater speaker made today.



PFIW675S

Its bulletproof Kevlar drivers sound incredibly natural and handle tons of power. The versatile design fits any standard stud bay, horizontally or vertically. The IW675S is the in-wall for hardcore home theater enthusiasts.

This is the speaker you need for a high-performance, yet compact in-wall home theater or media room system. The IW575S's Kevlar



PFIW575S

woofers and aluminum tweeter deliver dynamic, high-impact, realistic surround sound. The speaker's compact frame lets you mount it horizontally or vertically in a standard 16-inch-on-center stud space.

In-Wall Speakers - priced per pair

PFW895S	8" inwall speaker, Kevlar woofers, 1" pivoting aluminum dome tweeter, 125 Watts, 8 Ohms impedance	275.00
PFW695S	6-1/2" Inwall Speakers, Kevlar woofers, 1" pivoting aluminum dome tweeter, 150 Watts, 8 Ohms impedance	240.00



PFW895S

Proficient's finest in-wall speaker, the W895s, is a fantastic product. Its big cast-basket Kevlar woofer gives it powerful deep bass, yet it's so sensitive you can drive it to loud levels with a 10-watt amplifier. It's a superb choice for stereo, multiroom or any channel of a home theater system—and the easiest way to build a concealed high-end sound system.



PFW695S

Here's the best 6½-inch single-woofer in-wall Proficient has ever offered. The W695s has a Kevlar-cone woofer for ultra-deep bass power and low distortion, and a pivoting aluminum-dome tweeter for clear, extended treble. High sensitivity means that even a low-powered amplifier can get the W695S really cranking!

For questions on speaker wire and pre-construction brackets, please refer to page 164 or give us a call at 800-282-8864!

Floor-Standing Subs - priced each

PFFS12	Subwoofer with 12" long excursion treated paper cone woofer and 250W multi-voltage amplifier, slotted rear-firing port eliminates vent noise and distortion, black wood grain finish & chrome feet, LFE input, auto power	310.00
PFFS10	Subwoofer with 10" long excursion treated paper cone woofer and 120W multi-voltage amplifier, slotted rear-firing port eliminates vent noise and distortion, black wood grain finish & chrome feet, LFE input, auto power	250.00
PFFS8	Subwoofer with 8" long excursion treated paper cone woofer and 80W multi-voltage amplifier, slotted rear-firing port eliminates vent noise and distortion, black wood grain finish & chrome feet, LFE input, auto power	190.00



PFFS12

PFFS10

PFFS8

Outdoor Rock Speakers - priced per pair

PFR800*	One pair 8" graphite woofer, 1" polyamide dome tweeter and 90W of power handling	220.00
PFR650*	One pair 6 1/2" graphite woofer, 1" polyamide dome tweeter and 60W of power handling	165.00



-G=Granite (Left)
*-S= Sandstone (Right)

Single Stereo Outdoor Speakers - priced each

PFAW600TT*	Single Point, 6 1/2" dual voice coil polypropylene woofer, two 1" Supernil soft dome pivoting tweeters, 125W	165.00
PFAW500TT*	Single Point, 5 1/4" dual voice coil polypropylene woofer, two 1" Supernil soft dome pivoting tweeters, 100W	125.00

*WHT for White, BLK for Black

PFAW500TTWHT



All Proficient outdoor speakers include swivel mounting brackets.

Why Install Proficient?

- Full line of speakers that is easy to understand
- Variety of speakers fit one pre construction bracket - makes upsells during trim easy
- Unmatched monthly promos mean more margin for you
- Great customer service - Proficient does not have unsatisfied dealers
- Experienced design team means Proficient sounds great

Outdoor Speakers - priced per pair

PFAW830*	8" polypropylene woofer, 3" graphite mid, 1" Supernil soft dome pivoting tweeter, 175W	295.00
PFAW650*	6 1/2" polypropylene woofer, 1" Supernil soft dome pivoting tweeter, 150W	220.00
PFAW525*	5 1/4" polypropylene woofer, 1" Supernil soft dome pivoting tweeter, 125W	170.00
PFAW400*	4" polypropylene woofer, 3/4" Supernil soft dome pivoting tweeter, 100W	130.00

*WHT for White, BLK for Black

All Proficient outdoor speakers include swivel mounting brackets.



PFAW830BLK

PFAW650BLK

PFAW525WHT

PFAW400WHT

In-Wall/Ceiling Sub System - priced each

PFIWS105	10" in-wall long excursion treated paper cone woofer, inverted ferrite magnet, 250W	225.00
PFICS11	10" in-ceiling long excursion graphite woofer, 175W	170.00
PFB- IWS10	Wood back box for PFIWS105, MDF dampened to reduce translational energy to wall, fits standard 16" stud bay	115.00
PFM3	180W high-current mono amp with built-in crossover network, features adjustments for subwoofer fine-tuning to individual room acoustics, includes bolt-on rack ears	325.00



PFM3



PFIWS105



PFBB-IWS10



PFICS11

Speaker Cover Plates

The Proficient speaker cover plates attach to the pre-construction brackets protecting them from damage during construction

PFPCP-800	One pair of white cover plates for 8" ceiling, LCR and single stereo speakers	20.00
PFPCP-600	One pair of white cover plates for 6 1/2" ceiling, LCR and single stereo speakers	20.00
PFPCW-600	One pair of white cover plates for 6 1/2" in-wall speakers	20.00

How is Commercial Audio Different?

The rules for residential audio, in most cases, don't apply for a restaurant, bar, or commercial building. The intended result is still good sound, but there are differences between commercial and residential design. With a residential system you are typically trying to please one or two listeners in a small area, while a commercial system must satisfy many listeners over a larger area. For example, a restaurant will have tables with people seated facing several different directions, so a residential system cannot provide a stereo image for all listeners. Commercial systems are designed to overcome the issues that a residential speaker system cannot. For example, you can install a large number of speakers on very long daisy-chained wire runs with a 25V/70V system. Commercial systems use higher voltage to result in lower current when distributing power to a sound system. This allows longer runs without overheating or wasted current. 70 volt systems are the most common, and most energy efficient, but some local electrical codes limit low-voltage installers to 25 volt systems. Commercial systems should not be used in residences.

25/70 Volt Commercial Amplifiers

STPVL15A	PVL-Series 15W amplifier, 2 mic inputs, and 1 AUX input	85.31
STPVL30A	PVL-Series 30W amplifier, 2 mic inputs, and 1 AUX input	116.16
STPBM30	Contractor Series 30W amplifier, 2 mic inputs, 1 RCA, telephone page input	151.50
STPMM60A	60W PA mixer power amplifier with 6 inputs	321.24
STPBM120AU	120W PA mixer amplifier with USB input. Includes Tuner and CD player	673.46
STPMM120A	120W PA mixer power amplifier with 6 inputs	423.66
STPL200M	160W, 5-source, 4-zone, matrix distribution PA amplifier	480.86
STPFA	Digital AM/FM tuner with 30 presets	177.61



STPFA



STPL200M

25/70 Volt Speakers



STSP30PT



STSP5MAT



STSP6AWXT



STG86TG



STSPG86TC



STSPC40RT



STPVL30A

STSP5MAT	5.25" commercial in-ceiling speaker, flame-retardant ABS back box, 2W - 50W, each	52.46
STSP6MAT	6.5" commercial in-ceiling speaker, flame-retardant ABS back box, 2W - 60W, each	59.95
STBRC6F	In-ceiling bracket for SP5MAT and other 6" speakers, 8.375" cutout dim, pair	30.35
STBRC8F	In-ceiling bracket for SP6MAT and other 8" speakers, 9.875" cutout dim, pair	30.35
STSP6AWXT*	6.5" all-weather design surface-mount speaker with transformer, 3W - 50W, pair (* blank for black, W for white)	137.39
STSPC40RT	6.5" x 11" Weather Resistant Horn Speaker	62.45
STSP30PT*	Hanging 5.25" pendant speaker with hanging chain, 2.5 - 30W, each (* blank for white, B for black)	64.95
STSPG66T	6" Contractor Series Speaker, 7.625" cutout, 0.25W to 5W, each	16.86
STSPG86T	8" Dual Cone Modern Grille Ceiling Speaker with Transformer, uses STBRC8F bracket, 1/4W - 5W, each	18.49
STSPG86TC	8" Dual Cone Modern Grille Ceiling Speaker with Transformer & Volume Control, uses STBRC8F bracket, 1/4W - 5W, each	24.36
STG86TG	8" Dual Cone Classic Grille Ceiling Speaker with Transformer, 1/4W - 5W, each	18.49
STTS8	Speaker ceiling support for G86TG, T-bar bridge for ceiling support of 8" speaker, top hat, & bracket, each	7.24
STSTH8	Top Hat, metal back box for 8" speakers, each	12.12
STSPCDC6	Residential 8 Ohm in-ceiling speakers, 7.5" cutout, use STBRC6F rough-in	62.45

Commercial Audio Accessories

STWAT10W	10W, 70 volt, mono attenuator, single-gang white plate	16.42
STWAT50	50W, 70 volt, mono attenuator, single-gang stainless steel plate	20.73
STMUHF101	UHF 1-channel wireless receiver for microphone	179.61
STMUHFHH	UHF wireless handheld microphone	93.05
STMUHFLL	UHF wireless lapel microphone	93.05
STMCHH100A	Handheld dynamic microphone - wired	16.61
STMHL5S	Gooseneck adjustable desktop microphone, lockable talk switch	57.08
STMCA20	20' microphone cable XLR connectors	19.48



STMUHFLL



STMUHF101



STMUHFHH



STWAT10W

Free Audio Design service at www.specotech.com

Allow Your Speakers to Perform to Their Maximum Potential

Sometimes you don't hear the difference between top quality speakers and generic models. Is the problem the speaker or the place it was installed?



Sometimes even the very best speakers don't sound their best when installed in a standard wall or ceiling structure. Without an enclosure system, sound resonates throughout the surrounding structure, creating muddy, back-wave distortion and unwanted noise and vibration to adjacent rooms. Dynamat's revolutionary enclosure systems dramatically improve sound quality and reduce unwanted noise to other rooms. In-wall and in-ceiling speakers now sound like speakers mounted in solid, well-crafted cabinets. Before you invest in top quality speakers, make sure you are installing them in a top quality location.



In-Wall Speaker Enclosures

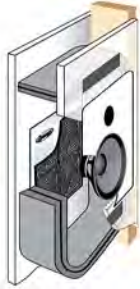

En-Wall significantly reduces wall vibration, projects more clear sound into the room and reduces unwanted noise transfer through walls. It combines Dynamat Xtreme, DynaXorb and the SoundSnake to damp, diffuse, and decouple in-wall speakers. En-Wall encases in-wall speakers creating an optimal acoustic environment for delivering premium sound quality.

En-Wall is an easy-to-retrofit speaker enclosure for in the wall. It reduces the sonic cancellations that are often created from in-wall speakers operating in long, shallow spaces. Kits for En-Wall are available in single speaker packages for either 4" or 6" stud walls.

En-Wall Enclosure System

DYN50504	(1) 1.5" x 3.5" x 54" SoundSnake w/ Dynil (4) 6" x 6" DynaXorb (1) 12" x 18" Dynamat Xtreme (2) 4" x 10" Dynamat Xtreme	44.48
DYN50506	(1) 1.5" x 5.5" x 54" SoundSnake w/ Dynil (4) 6" x 6" DynaXorb (1) 12" x 18" Dynamat Xtreme (2) 4" x 10" Dynamat Xtreme	46.82

Ceiling Speaker Enclosures

DynaBox is a ceiling speaker enclosure. It completely encases the speaker, effectively reducing sound migration between ceilings and floors. DynaBox projects more clear sound into the room and reduces unwanted sound traveling outside the room. It is designed to be folded and is easy to retrofit.

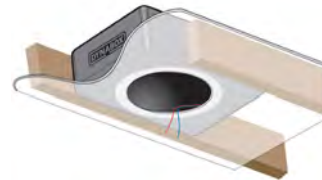

DYN50306

DYN50306	Kit includes: (1) DynaBox 17" x 12" x 6.5" (1) SoundSnake 1.5" x 5.5" x 54" (1) Back-Wave Foam 13.5" x 9" x 1"	79.60
----------	-------------------------------------------------------------------------------------------------------------------------	-------

Reduce Sound Through the Walls



Reduce Sound Created by HVAC and Appliances

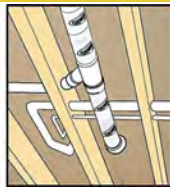

DYN50455

Unwanted noise produced by vibrating sheet metal is a common problem in every household. Dishwashers, air conditioners, duct work, and piping create irritating noise problems that keep you from enjoying music, movies and everyday family life. Many home theaters are also adding multimedia systems with metal enclosures that include fans. All these items are made from sheet metal and can be made quieter with an application of Dynamat Xtreme.

Dynamat Xtreme

DYN50400	Utility pack, (24) 4" x 10" pieces	51.50
DYN50455	Bulk pack, (9) 18" x 32" pieces	145.17

Application Note

Quiet your Equipment Rack.
Reduce the sound of computers and DVRs.



Don't block air vents! Cover as much surface area as possible.

Reduce Sound Through the Floors

DynaPad is an effective sound barrier that reduces sound transmission through floors. It can be used on any floor above or below to block outside noise and keep your theater sounds inside your theater. Installed under the carpet in the upstairs bedroom, DynaPad ensures a quiet sleep even if the kitchen dishwasher is running.

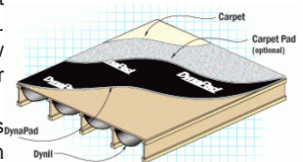

DynaPad Sound Barrier

DYN50110	54 in. x 25 ft. long roll	580.77
----------	---------------------------	--------

Keep appliance noise out of your TV room.



HDMI Matrix Switchers

HDMI Matrix Switchers allow you to share multiple HD sources to multiple HD displays. Some units use standard wiring and some use a hybrid with Cat 5e. Control can also be passed over the same Cat 5e cable.



Pages 168-169

Matrix Switchers

Matrix switchers allow you to share multiple sources to multiple displays. Some units use standard wiring and some are hybrid with Cat 5e.



A/V Custom Controls

On Controls and BitWise give you the ability to customize an interface to support your customer's needs. Using these utilities will enhance the user experience and give the customer a very easy solution for app and remote control.



Page 35



A/V Distribution over Cat 5e

MuxLab is a leading designer of value-added connectivity hardware allowing CCTV and audio-video equipment to be connected via cost-effective copper twisted pair. Today, almost any type of signal can be sent over Cat 5e using MuxLab baluns.



Page 171

Switches

Switches allow you to send multiple sources to multiple displays, however all displays show the same content.

Distribution Amplifiers

Distribution amplifiers allow you to take a single source and send it to multiple displays without quality loss.

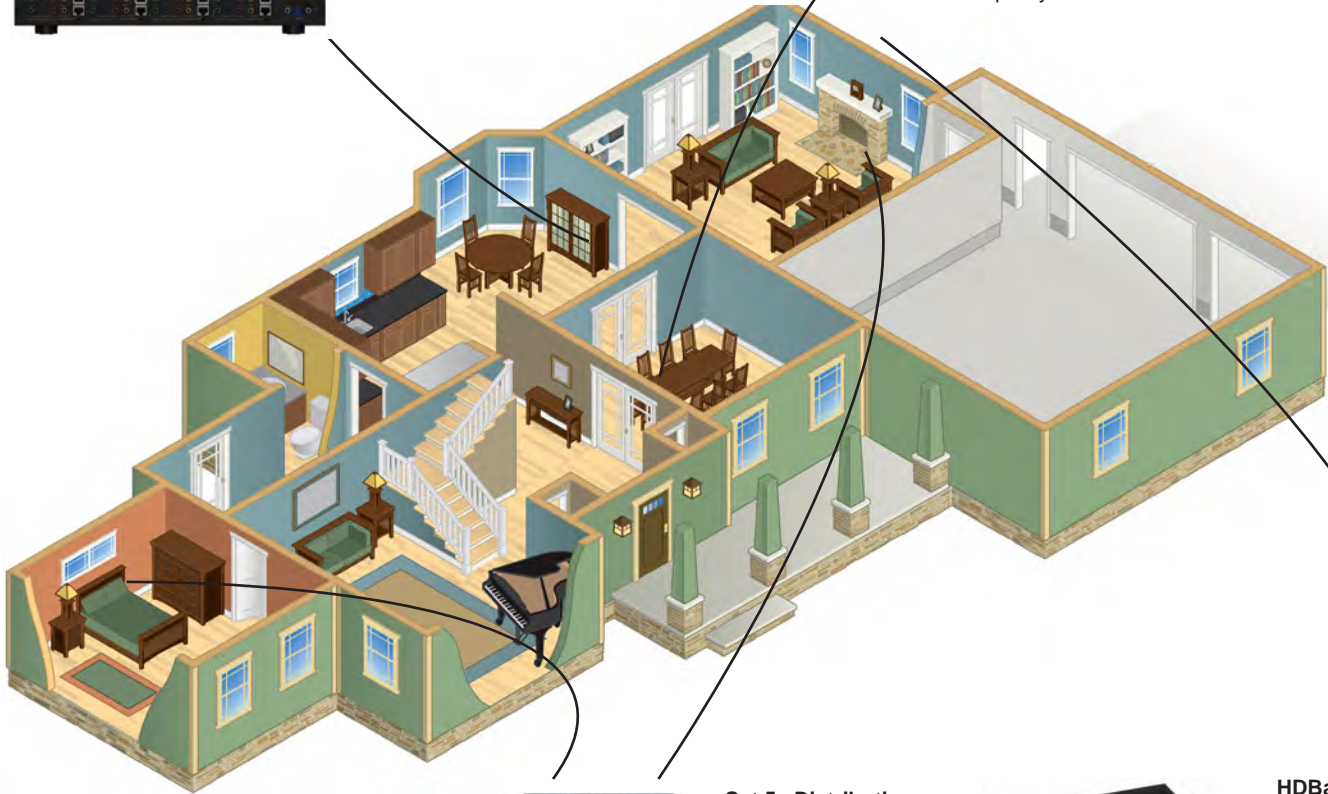

4K Video

When looking for more than 1080P resolution check out 4K quality video. As opposed to the 720 or 1080 lines of resolution, 4K video features 4,000 lines of resolution bringing the T.V./projector screen to life!



Cat 5e Distribution

Cat 5e distribution allows you to use inexpensive UTP wire to distribute signals to locations where the proper wire is either not available or not cost-effective. Baluns allow for point to point distribution and matrices allow switching.



HDBaseT

HDBaseT allows for video (up to 1080p), Ethernet and IR/Serial Control all over a single Cat 5e up to 100m (330ft). By combining all of these signals into a single cable, installations become easier for both the installer and the homeowner.

HDMI Extenders



Technology	HDBaseT	HDBaseT	HDBaseT	HDBaseT	HDBaseT	HDBaseT
Single Cat 5	Yes	Yes	Yes	Yes	Yes	Yes
4K Support	Yes	Yes	Yes	Yes	Yes	Yes
EDID Control	Yes	Yes	Yes	Yes	Yes	Yes
Audio De-Embed	No	No	No	No	Yes	Yes
Full Buffer	Yes	Yes	Yes	Yes	Yes	Yes
2-Way IR / RS-232	Yes	Yes	Yes	Yes	Yes	Yes
Ethernet	No	No	No	No	No	No
HDMI Pass-Through	No	No	No	No	No	No
Distance @ 4K On Any Cat 5e/6	150'	150'	125'	125'	150'	150'
Distance @ 4K On KD Cat 5e/6	125'	125'	150'	150'	125'	125'
Distance @ 1080p On Any Cat 5e/6	230'	230'	200'	200'	230'	230'
Distance @ 1080p On KD Cat 5e/6	250'	250'	250'	250'	250'	250'
Part Number	KDGKD-X222	KDGKD-X222PO	KDGKD-X422POA	KDGKD-X422WP	KDGKD-IP120POET	KDGKD-IP120POER
Price	198.00	234.00	348.00	510.00	321.00	292.00

HD over IP



HD over IP-TX	HD over IP-RX
KDGKD-IP120TX	KDGKD-IP120RX
233.00	204.00

Key Digital's HD over IP solutions create an expandable HDMI over IP system that can be scaled to fit any installation. Add up to 1024 transmitter (tx) units and an unlimited number of receiver (rx) units for the ultimate custom video solution. These modules can be connected through a network IP switch or point-to-point and provides an ideal solution for large video distribution applications.

- Wi-Fi extender: up to 100 ft.
- IP over Coaxial: up to 1,000 ft.
- Supports up to 1080p and compatible with DVI1.0/HDMI/HDCP1.x
- Up to 400 ft. @1080p using CAT5e/6 UTP/STP cable

Video Converter



Converts VGA HDMI, also embeds analog audio input into HDMI output, up-scales VGA to 720p or 1080p

KDGKD-VCS500	Video Converter/Scaler,	175.00
--------------	-------------------------	--------

Champion ProK HDMI Cables

CL3/FT4 UL Rated, 31.5 Gbps, 1080p, Ultra HD/4K, Ethernet, Arc with RedMere Technology



KDGKD-PRO30G	VW1 Rated 30' HDMI Cable, 4K Support	101.00
KDGKD-PRO40G	VW1 Rated 40' HDMI Cable, 4K Support	124.00

Audio Devices



Converts Digital Coaxial or Toslink Audio to Analog (L/R) Audio

KDGKD-DAXAA	2-channel PCM Coaxial and Optical Digital to Analog L/R Audio Converter	49.00
-------------	-------------------------------------------------------------------------	-------

Champion HDMI Cables

KDGKD-PRO3	VW1 Rated 3' HDMI Cable, 4K Support	7.00
KDGKD-PRO6	VW1 Rated 6' HDMI Cable, 4K Support	9.00
KDGKD-PRO9	VW1 Rated 9' HDMI Cable, 4K Support	14.00
KDGKD-PRO12	CL3 Rated 12' HDMI Cable, 4K Support	18.00
KDGKD-PRO16	CL3 Rated 16' HDMI Cable, 4K Support	24.00
KDGKD-PRO20	CL3 Rated 20' HDMI Cable, 4K Support	31.00

Video Wall Processor



KDGKD-VW4X4PRO	4 Inputs to 4 Outputs Video Wall Processor, supports Seamless Matrix Switching	2,100.00
----------------	--------------------------------------------------------------------------------	----------

Make standard consumer TVs and monitors into a huge video wall with the Key Digital HDMI Video Wall Processor. Four HDMI/VGA inputs accept digital/analog video and audio from computers, media players, and other sources. With the eight onboard video wall processing modes, the four outputs can be configured to display video from a single input over a four-output video wall (See left). Adjustments such as bezel compensation let you fine-tune your video wall to fit different screen types.



HDMI Switchers

3D Ready - Capability to pass 3D stereoscopic signal formats
4K Resolution Support - 4096x2160/24 video resolution support
Light Buffer Technology - Multiple output viewing mode is supported by a dynamic realignment in clocking that may appear as a short blink when multiple displays/outputs select a single source/input. This dynamic re-clocking improves video quality on all displays and does not affect switcher performance during non-switching operation, built into matrix switchers.
Wide Resolution Support - Supports all SD, HD, UHD 4K and VESA (VGA, SVGA, XGA, WXGA, SXGA, UXGA) resolutions up to 1080p (60Hz & 50Hz)
 » SD & HD: 480i, 480p, 720p, 1080i, 1080p
 » VESA / VGA (RGBHV): From 640x480p up to 1920x1200p
Supports lossless compressed digital audio - Dolby® TrueHD, Dolby® Digital Plus and DTS™-HD Master Audio



Working with HDMI signals can be complicated. Any installer who has dealt with the pitfalls of HDMI certainly knows that. They also know that there is no shortage of low-cost HDMI switching and transmission accessories that don't always get the job done well. With the Champion Series from Key Digital, you no longer need to sacrifice quality and performance for price. Champion has been designed to compete at the prices of the low-cost brands while still incorporating the features and performance that Key Digital is known for.

All Models Support 4K		
KDGKD-8X8CSA	8x8 HDMI Matrix Switcher, IR/RS-232/ front panel control, supports lossless compressed digital audio, audio de-embedding, internal EDID library with 9 configurations	1,905.00
KDGKD-4X4CSA	4x4 HDMI Matrix Switcher, IR/RS-232/ front panel control, supports lossless compressed digital audio, audio de-embedding, internal EDID library with 9 configurations	735.00
KDGKD-S4X1	4 In to 1 Out HDMI Switcher Version 2.2	147.00
KDGKD-S2X1	2 In to 1 Out HDMI Switcher Version 2.2	111.00
KDGKD-DA1X4	1 In to 4 Out HDMI Distribution Amp	153.00
KDGKD-DA1X2	1 In to 2 Out HDMI Distribution Amp	129.00

AV over IP

Encoder and Decoder

Key Digital's Enterprise AV over IP encoders and decoders create expandable HDMI over IP systems that can be scaled to fit any commercial installation and offer a variety of usage modes.

KDGKD-IP922ENC	Enterprise AV over IP Encoder, Supports 4K, 2 POE LAN ports, Local HDMI switching	795.00
KDGKD-IP922DEC	Enterprise AV over IP Decoder, Supports 4K, 2 POE LAN ports, Local HDMI switching	750.00



Transmitter and Receiver

KDGKD-IP1080RX	HDMI over IP with POE - Receiver	270.00
KDGKD-IP1080TX	HDMI over IP with POE - Transmitter	300.00

- Connectivity: Can be connected through a network IP switch or point-to-point
- H.264 Compression: Ideal standard for large video distribution applications
- Custom System: Add Tx and Rx extenders to an existing system to expand HDMI over IP up to 1024 Tx units and unlimited amount of Rx units
- Power Over Ethernet: Carry power to Tx and Rx units with a Power Over Ethernet enabled Smart Managed Switch



MultiView Matrix

The MultiView Matrix switcher allows you to arrange up to 4 inputs in a variety of layouts on up to two outputs. It's great for corporate conference rooms, sports bars, or even the avid home sports enthusiast. Switching times are the fastest we have ever seen!

KDGKD-MLV4X2PRO	4 Inputs to 2 Outputs MultiView Seamless Matrix Switcher, Ultra HD/4K	2,100.00
-----------------	-----------------------------------------------------------------------	----------

Compass Control System

KDGKD-MC1000	Compass Control Master Controller	875.00
KDGKD-ZRX200	ZigBee Receiver for KD-ZRC300 Remote	110.00
KDGKD-ZRC300	Handheld Hard Button Remote	137.50



HDBaseT HDMI Matrix Switchers



KDGKD-PRO6X6CC
Includes HDBaseT Cat 6e/6 receivers for each output

Compass Control Built-In

KDGKD-PRO8X8CC	8x8 HDMI Matrix Switcher, HDBaseT single Cat 5e/6 output, simultaneous availability of HDMI and HDBaseT outputs, 8 Cat 5e/6 receivers included, independent PCM audio and IR inputs/ outputs, 1080p, 3D ready, 4K support, control via IR, RS-232, TCP/IP, front panel	4,500.00
KDGKD-PRO6X6CC	Same as above but 6x6, 6 Cat 5e/6 receivers included	3,150.00
KDGKD-PRO4X1	4 to 1 HDMI Switcher, Supports SD, HD, and VESA up to UHD/4K	300.00

Roaming Solved with Whole-Home WiFi Kits

LUXUL



Wireless Router Kit
WS-250



Wireless Router Kit
WS-100

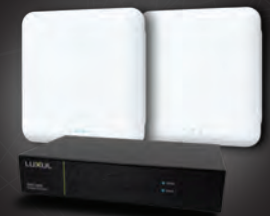

Wireless Controller Kit
XWS-2510



Wireless Controller Kit
XWS-1810



802.11ac

High-speed WiFi for ultra-fast streaming and bandwidth-intensive applications.



Wireless Controller

Wireless controller with Luxul Roam Assist™ allows clients to roam freely.



Fast Setup

Simple GUI for fast and intuitive setup.



Expandable System

Effortlessly add an access point for additional indoor or outdoor WiFi coverage.



Powerful Configuration

Easily enable essential features like security, remote access and media sharing.

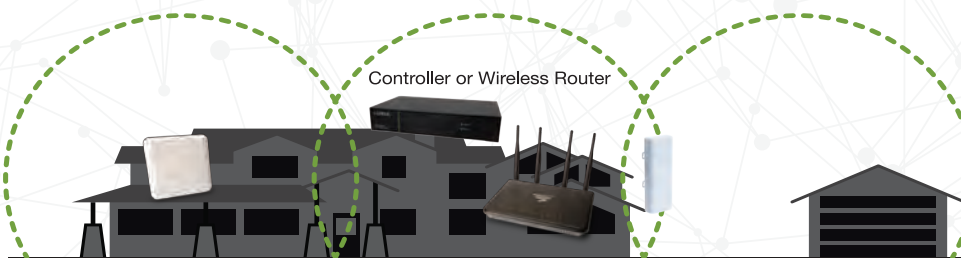

Whole-Home WiFi Coverage Including Exterior with Roaming (Additional AP Sold Separately)

MuxLab Inc. is a leading designer of value-added connectivity hardware allowing CCTV and audio-video equipment to be connected via cost-effective copper twisted pair. For almost 30 years, the MuxLab brand has been synonymous with quality, performance and reliability.

AV over IP

AV over IP has quickly become the industry-standard for installations in both commercial and residential markets. There are virtually no distance limitations, making it convenient and cost effective to connect and access AV across the home or around the world.

MUX500752	HDMI over IP Extender with PoE	458.38
MUX500753	HDMI / RS232 over IP Extender	472.12
MUX500757	HDMI over IP H.264 Extender with PoE	559.55
MUX500758	4K over IP Extender Kit with PoE	658.22
MUX500760-*	4K/60 Uncompressed over IP Extender	1,060.40
MUX500762-*	HDMI over IP H.264/H.265 PoE Extender	374.70

Send and Receive modules sold separately. (*=RX/TX)



MUX500752



MUX500758



MUX500762

Audio-Video Baluns

MUX500050-2PK	RGB male & digital audio 1080i/p - 500' 2-pack	96.17
MUX500052-2PK	RGB male & analog audio 1080i/p - 500' 2-pack	96.17
MUX500058-2PK	RGB male & stereo audio balun 1080i/p - 500' 2-pack	159.87
MUX500054-2PK	Component video/IR pass-thru balun 2-pack	96.17
MUX500001	Stereo audio-video balun - 2200' *	44.34
MUX500012	Dual audio-video balun - 1000' *	44.34
MUX500019	Analog audio balun - 5000' *	19.36
MUX500027	Stereo audio balun - 5000' *	29.98
MUX500028-2PK	Stereo Hi-Fi balun - 3250' * 2-pack	63.07
MUX500033	Quad audio balun - 5000' *	44.34
MUX500039	Audio/RS232/IR over IP Extender Kit w/POE	37.47
MUX500200	Audio-video distribution hub - 2200' *	428.41

* - When used with a DVR, maximum distance for video is 1,000 - 1,500 ft.



MUX500027



MUX500028



MUX500033

HDMI Matrix Switches



MUX500419POEUS



MUX500412POEUS

MUX500419POEUS	HDMI 8x8 Matrix Switch, 4HDMI+4HDBT, PoE	2,605.41
MUX500468-POE	HDMI 4x8 Matrix Switch, 4HDMI+4HDBT, PoE	3,560.90
MUX500412POEUS	HDMI 4x4 Matrix Switch, HDBT, PoE	1,318.94
MUX500418-POE	HDMI 4x8 Matrix Switch, HDBT, PoE	2,702.84
MUX500469POEUS	HDMI 8x8 Matrix Switch, HDBT, PoE	4,021.78
MUX500480US	Multimedia Matrix, 16x16 HDMI 2.0 4K	6,562.25

ProDigital Network Controller

MUX500811	Network Controller	296.01
-----------	--------------------	--------



The Network Controller allows users to manage their hub-installed MuxLab products via an Ethernet Web interface.

HDMI Over Dual Cat5e / Cat6



MUX500401



MUX500402



MUX500401	HDMI Extender Kit, up to 150ft**	173.61
-----------	----------------------------------	--------

MUX500402	HDMI Passive Extender Kit, up to 100ft**	144.88
-----------	------------------------------------------	--------

** Requires (2) Cat 5e/Cat 6 cables for maximum distance

HDMI Over Single Cat5e / Cat6



MUX500451



MUX500450



MUX500450	HDMI Mono Extender Kit w/ IR, up to 330ft	330.98
-----------	-------------------------------------------	--------

MUX500451	HDMI Mono Extender Kit, up to 230ft	263.54
-----------	-------------------------------------	--------

MUX500453	HDMI/LAN Extender Kit, up to 330ft	360.96
-----------	------------------------------------	--------

MUX500753	HDMI/RS232 Over IP Extender kit w/ PoE	472.12
-----------	----------------------------------------	--------

MUX500752	HDMI Over IP Extender Kit w/ Poe	458.38
-----------	----------------------------------	--------

Specialty 4K / HDMI Extenders



MUX500759



MUX500780

MUX500754	Video Wall over IP with PoE	490.86
-----------	-----------------------------	--------

MUX500759	Video Wall 4K over IP, PoE Extender Kit	723.17
-----------	-----------------------------------------	--------

MUX500757	HDMI over IP H.264 Extender Kit with PoE	559.55
-----------	------------------------------------------	--------

MUX500465	HDMI Over Coax Extender Kit, up to 500ft using 1 coax cable	394.68
-----------	-------------------------------------------------------------	--------

MUX500780	HDMI Wireless Extender Kit, 100ft	263.54
-----------	-----------------------------------	--------

VGA Baluns



MUX500040



MUX500042



MUX500041-WP-US

MUX500040	VGA Balun II video balun PC side. 350ft.	53.71
-----------	------------------------------------------	-------

MUX500042	VGA Balun II video balun monitor side. 350ft.	53.71
-----------	-----------------------------------------------	-------

MUX500040-42-PK	VGA Balun II Kit. Includes (1) MUX500040 and (1) MUX500042. 350ft.	96.17
-----------------	--------------------------------------------------------------------	-------

MUX500041-WP-US	VGA Balun II wallplate display side. 350ft.	69.94
-----------------	---------------------------------------------	-------

MUX500043-WP-US	VGA Balun II wallplate source side. 350ft.	69.94
-----------------	--------------------------------------------	-------

HDMI Cables and Accessories

BL181278	3Ft. M/M gold plated 1080p, CL3	2.04
BL181279	6Ft. M/M gold plated 1080p, CL3	2.27
BL181267	10Ft. M/M gold plated 1080p, CL3	2.74
BL181268	15Ft. M/M gold plated 1080p, CL3	3.83
BL181269	20Ft. M/M gold plated 1080p, CL3	5.86
BL181290	30Ft. M/M gold plated 1080p, CL3	15.08
BL181294	50Ft. M/M gold plated 1080p, CL3	23.62
BL181296	60Ft. M/M gold plated 1080p, CL3	41.88
BL181276	75Ft. M/M gold plated 1080p, CL3	47.52
BL181277	100Ft. M/M gold plated 1080p, CL3	64.94



BL181312

BL181312	10Ft. M/M gold plated, CL3, 4K	8.69
BL181313	15Ft. M/M gold plated, CL3, 4K	9.91
BL181340	20Ft. M/M gold plated, CL3, 4K	26.12
BL181341	30Ft. M/M gold plated, CL3, 4K	28.16
BL181342	40Ft. M/M gold plated, CL3, 4K	30.15
BL181343	50Ft. M/M gold plated, CL3, 4K	44.94
BL181344	60Ft. M/M gold plated, CL3, 4K	49.11
BL150630	VGA/Audio to HDMI Converter	16.31
BL110550	4x4 4K IR Controlled HDMI Matrix	199.60
BL101819WT	HDMI Keystone Coupler - White	5.00

USB Type C to Video Adapters

BL150212	3Ft. USB Type C to HDMI Male Cable - White	12.39
BL150213	6Ft. USB Type C to HDMI Male Cable - White	12.91
BL150216	3Ft. USB Type C to DVI Male Cable	12.73
BL150217	6Ft. USB Type C to DVI Male Cable	13.20



BL150213

Optical Cables for use with Nuvo Audio Players (see page XX)

BL201601	3Ft. Toslink/Toslink 2.2mm Digital Audio Cable	1.04
BL201602	6Ft. Toslink/Toslink 2.2mm Digital Audio Cable	1.63
BL201603	12Ft. Toslink/Toslink 2.2mm Digital Audio Cable	2.70
BL201604	20Ft. Toslink/Toslink 2.2mm Digital Audio Cable	3.71
BL201605	30Ft. Toslink/Toslink 2.2mm Digital Audio Cable	5.94
BL201606	50Ft. Toslink/Toslink 2.2mm Digital Audio Cable	7.56



BL20160x

Network Patch Cables

	Booted Cat 5E*		Non-Boot Cat 5E*		Booted Cat 6*		Non-Boot Cat 6*		Shielded Cat 6*	
0.5 Ft	BL100516	0.42	BL100416	0.40	BL100716	0.63	BL100100	0.63	BL100816	1.48
1 Ft	BL100501	0.45	BL100401	0.43	BL100701	0.70	BL100101	0.69	BL100801	1.63
3 Ft	BL100503	0.65	BL100402	0.63	BL100703	0.99	BL100103	0.97	BL100803	2.24
5 Ft	BL100504	0.86	BL100403	0.85	BL100704	1.30	BL100105	1.28	BL100804	2.85
7 Ft	BL100505	1.04	BL100404	1.03	BL100705	1.58	BL100107	1.57	BL100805	3.46
10 Ft	BL100506	1.40	BL100405	1.39	BL100706	2.02	BL100108	2.01	BL100806	4.41
15 Ft	BL100507	1.82	BL100406	1.81	BL100707	2.74	BL100109	2.73	BL100807	5.89
25 Ft	BL100508	2.84	BL100407	2.82	BL100708	4.20	BL100111	4.18	BL100808	8.92
50 Ft	BL100509	5.44	BL100408	5.43	BL100709	7.87	BL100112	7.86	BL100809	16.83
75 Ft	BL100510	8.07	BL100409	8.06	BL100710	11.53	BL100113	11.52	BL100810	25.06

* - Available in BK-Black, BL-Blue, GY-Gray, GN-Green, OR-Orange, PU-Purple, RD-Red, WT-White, and YW-Yellow



Key Digital HDMI over Single Cat-5e/6

KDGKD-X222	230' - 1080p, IR/RS-232, Tx/Rx set	198.00
KDGKD-X222PO	Same as above with Power over HDBaseT	234.00
KDGKD-X422POA	230' - 1080p, 125' - 4K, IR/RS-232, Tx/Rx set, Power over HDBaseT	348.00
KDGKD-X422WP	230' - 1080p, 125' - 4K, IR/RS-232, Tx/Rx set, Power over HDBaseT with Wallplate Transmitter	510.00



KDGKD-X422WP

Not sure which one you need? Give us a call today!

Worthington carries the full line of Key Digital products. For more information see pages 168-169 or give us a call.

Leviton Architectural Edition



Great paired up with Leviton Security and Automation Whole House Audio!

“9 OF 10 MAJOR LIVE CONCERTS ARE PERFORMED WITH JBL LOUDSPEAKERS”



See page 94-95 for Leviton whole house audio.

On-the-Wall Modular Home Theater System

JBL Systems measure up to a higher standard than typical home theaters because more JBL speakers are found in film recording studios and movie theaters than any other brand.

- Five-channel system that's expandable to 6.1 and 7.1 surround-sound operation with the addition of optional AESS5 satellite speaker(s)
- Includes 5 architectural-grade adjustable mounting brackets
- Includes 8" - 100W subwoofer and input RCA cable



LEVAEH50-*	On-wall or ceiling mounted (4) 2-way satellite speakers, (1) center channel, (1) powered sub- *Black or White	227.92
LEVAESS5-*	Additional satellite speaker for AEH50 - *BL-Black or WH-White	35.81

Home Theater Speaker Solutions

			LEVLAEI5I	Dual 5.25" in-wall center channel, 120W, 8 Ohm, each	237.95
LEVAECCS-VCE	LEVAEI55	LEVLAESW	LEVAECCS-VCE	Dual 5" shelf-mount center channel, 300W 8 Ohm, each	129.38
			LEVLAESW	Powered subwoofer, 12" woofer, 200W, each	285.55

JBL built-in home theater systems are designed for custom installers and system integrators who need maximum flexibility and performance.

Bluetooth Sound Bar

- Bluetooth connectivity to wirelessly stream music through any Bluetooth enabled device
- JBL SoundShift™ works with the TV and wireless mobile device at the same time to allow automatic switching between the sound from the TV or the sound from a phone or tablet
- Cinematic sound with Dolby® Digital and Harman Display Surround sound
- Harman Volume makes sudden volume changes smooth and consistent reducing the impact of loud commercials and low dialogue volume



LEVLAESB	Bluetooth Soundbar with Wireless Subwoofer	285.55
----------	--------------------------------------------	--------

In-Ceiling and In-Wall Speakers

LEVLAIE6C	6.5" In-Ceiling speaker, 80W, 8 Ohm, Pair	139.85	LEVLAIE65	6.5" in-wall speaker, 80W, 8 Ohm, pair	160.83
LEVLAIE8C	8" In-Ceiling speaker, 100W, 8 Ohm, Pair	179.82	LEVAIEC65	6.5" In-ceiling speaker, 80W, 8 Ohm, pair	124.40
LEVLAIE6D	6.5" In-Ceiling Stereo Speaker, 80W, 8 Ohm, each	239.77			



LEVLAIE6C



LEVLAIE8C



LEVLAIE6D



LEVLAIE6I

The JBL ceiling and in-wall speakers in the Leviton program feature JBL's famous EOS® waveguide technology used in professional sound systems.



LEVAIE8I

Pre-Wire Brackets and Accessories

LEVAEPC8-KIT	8" ceiling, pair	23.88
LEVPC55-KIT	6.5" ceiling, pair	19.91
LEVAEPI6-KIT	6.5" wall, pair	19.91
LEVAEPI8-KIT	8" wall, pair	23.88
LEVAEHTK	7.1 HT interface plate	72.47
LEVAEPIS-KIT	Shelf for AEI55	34.83
WAVAC1402RWH15	14/2 Audio Cable, 14AWG, 500' box white	99.92
WAVAC1602RWH15	16/2 Audio Cable, 16AWG, 500' box white	66.20

8 Ohm Speaker Wiring

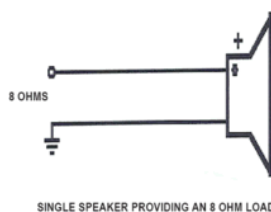

SINGLE SPEAKER PROVIDING AN 8 OHM LOAD

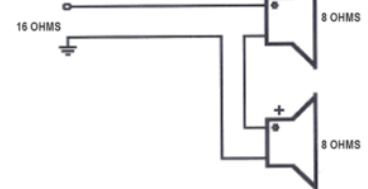

TWO 8 OHM SPEAKERS WIRED IN SERIES

See pages 214-215 for speaker wire.

WiFi, IP, HTTP Enable Serial, Relay and IR Devices

Introducing



Connect. Command. Control.



WiFi, IP, and, PoE Products
that Connect Your
Serial, Relay, and IR Devices
to a Network
Using Existing Controllers,
Systems, and Apps!



iTach Devices



Flex WiFi and
Flex Link 3 Emitter Cable



Flex IP and
Flex Link Relay RS232 Cable



Flex IP and
Flex Link Relay & Sensor Cable

Home Theater Series Projectors



OPTGT1080DARBEE

Complete the home theater of your dreams with one of these HD projectors. With contrast ratios up to 2000000:1 you will get a clear, crisp picture every time. If you have sources that are not HD, Worthington carries several products to upconvert them; this is also known as scaling. These projectors all have full 3D support.

Worthington carries many Optoma projectors for applications ranging from home theater to commercial and even interactive projectors (see below).

	Proj. Distance	Max Resolution	Brightness	Contrast	Image	Lamp Watts	Lamp Life	
OPTGT1080DARBEE	1.64'–11'	1080p (1920x1080)	3000 Lumens	28000:1	45.3"–303.2"	190W	5000 hours	741.40
OPTML750ST	1.41'–11.29'	720p (1280x800)	700 Lumens	20000:1	25"–200"	LED	20000 hours	531.30
OPTHD39DARBEE	5.08'–25.09'	1080p (1920x1080)	3500 Lumens	32000:1	26.2"–301.1"	260W	4000 hours	889.90
OPTHD27E	3.2'–35.37'	1080p (1920x1080)	3400 Lumens	25000:1	28"–301"	240W	3500 hours	628.10
OPTUHD50	2.9'–34.89'	4K (3840x2160)	2400 Lumens	500000:1	34.1"–302.4"	240W	4000 hours	1,401.40
OPTUHD65	2.20'–25.18'	4K (3840x2160)	2200 Lumens	1200000:1	26.4"–302"	240W	3500 hours	1,923.90
OPTUHZ65	1.33'–48.42'	4K (3840x2160)	3000 Lumens	2000000:1	26.4"–302.2"	Laser	20000 hours	3,298.90

Optoma's UHZ65 uses Laser Phosphor projection technology to provide a crisp, clear image.

OPTEH320USTI	1.47'–1.93'	1080p (1920x1080)	4000 Lumens	20000:1	80"–100"	260W	3000 hours	1,586.20
--------------	-------------	-------------------	-------------	---------	----------	------	------------	----------

Use the EH320USTI with White Board projector screens to create an interactive environment for classrooms, boardrooms and more.

4K UHD Projector - Controllable with Amazon Alexa

Take control of your home theater via voice commands with the Amazon Alexa-enabled Optoma UHD51A projector.

- 4K UHD (3840x2160) resolution
- 2400 lumens
- HDR10 support for brighter whites, deeper black-levels and vivid colors
- Dynamic Black delivers 500,000:1 contrast ratio
- HDMI 2.0 with HDCP 2.2 connectivity ensures compatibility with 4K video sources
- Vertical lens shift and 1.3x zoom for easy and flexible installation



OPTUHD51A	4K, 2400 lumens, 500000:1 contrast. Controllable with Amazon Alexa. Requires Amazon Echo device (Dot, Show, etc.)	CALL
-----------	-------------------------------------------------------------------------------------------------------------------	------

Worthington carries the full Draper line. Call for more information.



Clarion (Fixed/Permanently-Tensioned)

If motorized is not what you are looking for, take a look at these cost-effective wall/ceiling-mounted permanent screens. One-inch square, tubular aluminum frame creates a very clean, non-wrinkled viewing surface to enjoy your movies. Screens have 2" black vinyl borders. M1300 Finish listed.*



DR252139

DR252139	65" Screen, Size: 31.75" x 56.5" (16:9)**	465.02
DR252140	73" Screen, Size: 36" x 64" (16:9)**	491.15
DR252141	82" Screen, Size: 40.5" x 72" (16:9)**	546.54
DR252016	92" Screen, Size: 45" x 80" (16:9)**	622.82
DR252017	106" Screen, Size: 52" x 92" (16:9)**	775.39

*Other finishes are available. **Other formats avail. Call for information.

Silhouette (Motorized Tab-Tensioned)

If you are looking for a motorized screen to give your customer's home theater that "wow" factor, these wall/ceiling mount projection screens are for you. Matte White Finish listed.*



DR107250

DR107321	82" Screen, Size: 40.5" x 72" (16:9)**	1,729.99
DR107250	92" Screen, Size: 45" x 80" (16:9)**	1,588.40
DR107397	100" Screen, Size: 49" x 87" (16:9)**	1,607.21
DR107251	106" Screen, Size: 52" x 82" (16:9)**	1,628.11
DR107409	110" Screen, Size: 54" x 96" (16:9)**	1,638.56

*Other finishes are available. **Other formats avail. Call for information.

Other screen types available. Call for more information.

DR121222	LVC-IV Motor Control Board. Used to connect screens to control systems such as Leviton's Omni panels.	133.76
----------	-------------------------------------------------------------------------------------------------------	--------

Middle Atlantic Products

Middle Atlantic - What Great Systems are Built On

Worthington Distribution is providing just a few of the most-common uses for Middle Atlantic Products' products. With an almost 40-year track record, Middle Atlantic has many more solutions to offer. We carry Middle Atlantic's full line card.

At the heart of every great system, you'll find Middle Atlantic Products.
Visit www.middleatlantic.com to learn more.

Solution #1 - Pre-Configured, Floor Standing Rack

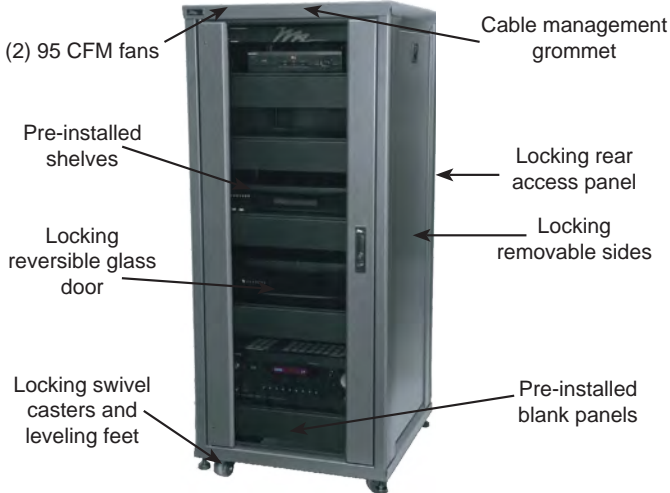

MARCS-2724

Pre-Configured and Installation-Ready Racks

Middle Atlantic's RCS series of pre-built equipment racks include everything you need for a rack: a reversible glass door, blank faceplates, pre-installed shelves, casters, sides, rear panel, and venting fans. Even though every RCS Series rack includes shelves for convenient equipment mounting, they are built on a professional rackmount foundation and accept both professional rackmount as well as shelf-mounted consumer components.

Dealer pricing starting at just \$313.64

Solution #2 - Power-Cycle Devices Remotely



MARLNK-SW215-NS

MARLNK-SW620R

Diagnose and Fix Problems Off-Site

A practical, web-enabled power management system which sets a new standard for cost-effective capabilities. Set-up takes less than five minutes. RackLink modules monitor the power and temperature conditions of your system, log and alert you to any irregularities, and even reboot to correct network problems on their own.

Features/benefits:

- Individual outlet control
- Monitor power and temperature
- Autoping network device diagnostic/utility
- Event logging and notification

Dealer pricing starting at just \$312.55

Solution #3 - Wall-Mount Video Recording



Clean Up Your Recording Devices

Middle Atlantic has solutions to mount NVRs and DVRs which will make your installations look great.

Use the components shown below for a trim and economical mounting option. The four rack units of space provides you with enough room for a DVR/NVR, a battery backup, and a network switch, all in a lockable on-wall enclosure.

The approximate shipping cost for these Middle Atlantic components is just \$23!

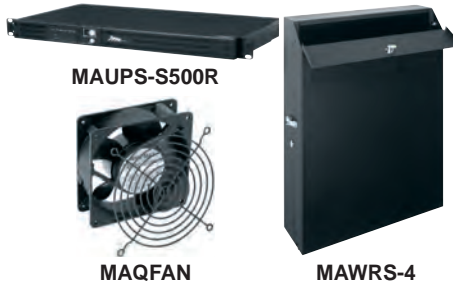

MAUPS-S500R

MAQFAN

MAWRS-4

Don't leave a rat's nest of wires like this behind. Use a low-profile WRS rack for a clean, secure, and professional installation.

Dealer pricing starting at just \$659.60

Solution #4 - Hideaway Home Theater

Put the Home Theater Out-of-the-Way

The Essex Quick Assembly Rack is an affordable, easy to build knock down rack. It features an innovative patent-pending snap-together design making it integration-ready in 5 minutes or less. The QAR Series provides the perfect foundation for entry level AV systems and can be outfitted with power and accessory options to suit any application.

Features/benefits:

- Patent-pending snap-together design saves 30 minutes or more of assembly time
- UL Listed, 800 lb. weight capacity
- Sleek metallic grey finish
- Includes lockable casters and a bracket for easy mounting of power and vertical lacing strips
- Generous facilities for bottom cable entry and passive ventilation for efficient airflow



QAR rack



MABUNDLE-SMALL



MAPWR-9-RP

Dealer pricing starting at just \$314.56

RSH Custom-Built Rackshelves

Features/Benefits of Middle Atlantic Products' Custom Rackshelves:

- Allows for installation of virtually any product into a standard 19" enclosure
- Includes a custom-cut faceplate for a clean look with no gaps around the component
- Can be ordered in an anodized finish or a brushed, paintable finish

Middle Atlantic guarantees shipment within 48 hours, and most custom rackshelves ship same-day

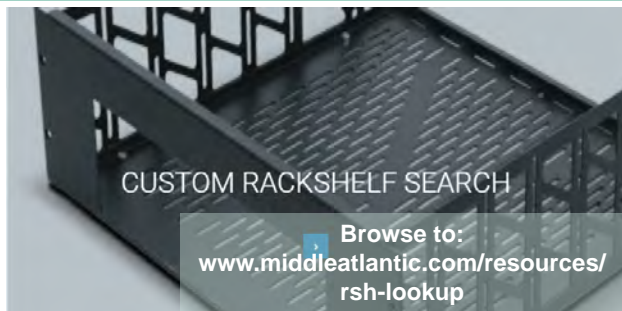

Middle Atlantic has dimensions for over 10,000 products in their database.

To find the correct custom rack shelf model number browse to <http://www.middleatlantic.com/resources/rsh-lookup> and search by manufacturer and model number or by keyword.

If your product isn't listed, you can enter the product dimensions to create a new part number.

All custom shelves follow this MAP pricing		2-5 sp.	6-12 sp.
MARSH4A	Black Anodized Finish	184.00	205.00
MARSH4S	Black Brushed Finish	154.00	195.00

Middle Atlantic Products



Middle Atlantic - What Great Systems are Built On

Middle Atlantic Products is a part of the Commercial AV division of Legrand, North America. All Middle Atlantic products are designed and engineered to meet the needs of installers and built in ways to save time and simplify the job.

- **An established company** - Middle Atlantic Products has been manufacturing products since 1979
- **A wide range of products** - from the ease of pre-assembled Essex racks to custom-built furniture with integrated racks, Middle Atlantic has exactly what you need to provide a professional solution
- **Short lead times** - Middle Atlantic builds all of their products in-house and has three warehouses to serve every region quickly and efficiently

At the heart of every great system, you'll find Middle Atlantic Products. Visit www.middleatlantic.com to learn more.

Middle Atlantic's Configurator Tool

Simplify Rack Installations with Middle Atlantic's Configurator

Middle Atlantic has made specifying and ordering their products easier than ever with their configurator tool. The Configurator guides you through laying out a rack, provides you with list pricing, and even calculates shipping. Best of all, registering for Middle Atlantic's Configurator is free!

Check out these great features of the Middle Atlantic Configurator



Browse & Design
Use the guide or explore on your own

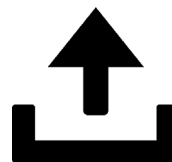

Export Your System
Export A & E's, quotes, CAD files, and more



24/7 Online Access
Always available online with no downloads



Free Factory Assembly
Saves you time



Freight Quotes
Know exactly what it will cost to deliver



Scan the QR code to see a demo of the Configurator.

Contact us to learn more about the Configurator.

Additional Rack Options

Middle Atlantic offers a full line of equipment rack solutions, including...



Floor-standing



Slide-out



Wall-mount



Knock-down



Mobile



... and many more

Visit www.middleatlantic.com for all of their rack options.

Worthington Distribution has access to Middle Atlantic's entire line of products.

If the part you are looking for is not listed in our catalog, please call (800) 282-8864 for price and availability.

MAP prices are shown. Please call or login to the Dealer Store for aggressive dealer pricing.

Affordable Flat Panel Mounts from Worthington Distribution

Have you been priced out of installing home theater display mounts by big box stores? We have your solution. Worthington Distribution is your source for low-cost, high-quality flat panel display mounts. All of these mounts are made of 1/4" high-quality steel, have a black scratch-resistant coating, and include all of the hardware you need to hang most displays. We back up these mounts with a no-hassle return policy: if you purchase one of these mounts and are dissatisfied with the quality of the materials or the packaging, we will take the mount back. Best of all, purchase any four mounts from this page, and receive a fifth one free.



Mount	Size	Capacity	Adjustments	Hole Pattern	Profile	Price
BL502676	LED 23-50"	77 lbs.	Fixed	Universal 50x50mm to 440x440mm	0.2" (5mm)	25.98
BL502677	LED 26-65"	100 lbs.	Fixed	Universal 50x50mm to 640x640mm	0.2" (5mm)	27.81
BL502670	32-50"	100 lbs.	Fixed	Universal 50x50mm to 650x400mm	1.1" (28mm)	25.95
BL502671	36-63"	165 lbs.	Fixed	Universal 50x50mm to 800x400mm	1.1" (28mm)	31.80
BL502669	23-37"	77 lbs.	Tilts -5° to +15°	Universal 50x50mm to 450x300mm	2.36" (60mm)	30.00
BL502672	32-50"	100 lbs.	Tilts -5° to +15°	Universal 50x50mm to 600x400mm	2.36" (60mm)	30.93
BL502673	36-63"	132 lbs.	Tilts -5° to +15°	Universal 50x50mm to 800x400mm	2.36" (60mm)	41.85
BL502647BK	32-55"	88 lbs.	Tilts +10° pans and swivels	Universal 75x75mm to 400x200mm	3.7 to 22" (95 to 575mm)	76.26
BL502721BK	23-42"	66 lbs.	Tilts +20° to - 20° pans and swivels	Universal 50x50mm to 600x400mm	4.5 to 22.5" (113 to 572mm)	101.85
BL502827	37-65"	132 lbs.	Tilts -5° to +15° pans and swivels	Universal 50x50mm to 800x400mm	4.5 to 22.5" (113 to 572mm)	108.75

Buy 4 mounts get 1 FREE! Free mount is of equal or lesser value.

Projector Mount

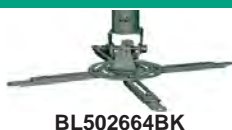

BL502664BK

Mount	Capacity	Adjustments	Profile	Price
BL502664BK	Fits most small to large projectors up to 44 lbs.	Pitch ± 20° Roll ± 20° Rotate 360°	22.6 to 32.5" from ceiling	26.60

Additional Home Theater Accessories

De-Clutter with Residential Racks



Middle Atlantic has a line of pre-configured racks which are priced to compete with the big box stores' off-the-shelf rack systems, while keeping Middle Atlantic's high standards of quality. These racks come with a reversible glass door, pre-installed shelves with blank face plates, casters, sides, rear panel, and venting fans to save you time in the field.

See pages 176-177 for more details.

Hide the Connections with a Recessed TV Box

Looking to keep a slim profile between the display and the wall? Plan to install an Arlington Industries TVB810 recessed TV box behind the display. This 8"x10" box comes with all of the hardware you need to set up a line-voltage outlet, a pass-through for your video cables, and even has a molded hanger to manage any cables which are longer than you need.

See page 211 for more details.



Get Connected with Home Theater Cables

Don't forget the cables when you make your bid to your customer. Worthington Distribution can be your source for high-quality, low-cost home theater cables. Our HDMI cables are Category 2 certified to support resolutions up to 4K. We also have component video, coaxial, SVGA, and even composite cables to meet any home theater need.

See page 172 for more details.



Control It All with a Mobile Device

With the universal remotes of the future you can offer full control of your customer's systems through a free app for their iPad, iPhone or Android. URC devices send commands over the network from the app and translates them to IR or serial to control devices.

See page 40 for more details.





Grandstream IP Phone system

The Grandstream IP phone system offers great features at a very affordable price. It supports standard analog as well as IP phone lines. Use the Android system phones and run apps from Google Play.



Page 180-181



2-Wire or IP intercom system

Comelit intercom systems can be scaled from 1 room all the way up to multi tenant residences. With the option for hardwired or IP, Comelit has the resolution for you!



Page 183



Video Doorbell

The Ring Video Doorbell lets you answer the door from anywhere in the world with your smartphone. Connects to your Wi-Fi network and works with iOS and Android devices. With the addition of spot and floodlight cameras, your whole home will be covered!



Page 37



Leviton IP door station

Leviton's new IP door station is a great addition to our Telephone/Communications arsenal. With a tamper-proof case and new sleek design, it can be integrated with the Grandstream SIP server.



Page 92

7-inch Android

This is the top of the Grandstream phone range. With no hard buttons, a 7-inch touchscreen, and fixed capacitive touch navigation buttons, it's like a tablet and system phone combined.



Cat5 Intercom Station
Place intercom stations in frequently used rooms.

Telephone System KSU

The brains of the operation. The KSU is where phone lines and phone stations are connected. It is mounted in the utility or media closet and should be close to the structured wiring enclosure for easy connection.



Cat 5 Intercom Hub

Mounts in the structured wiring enclosure and connects to all stations.

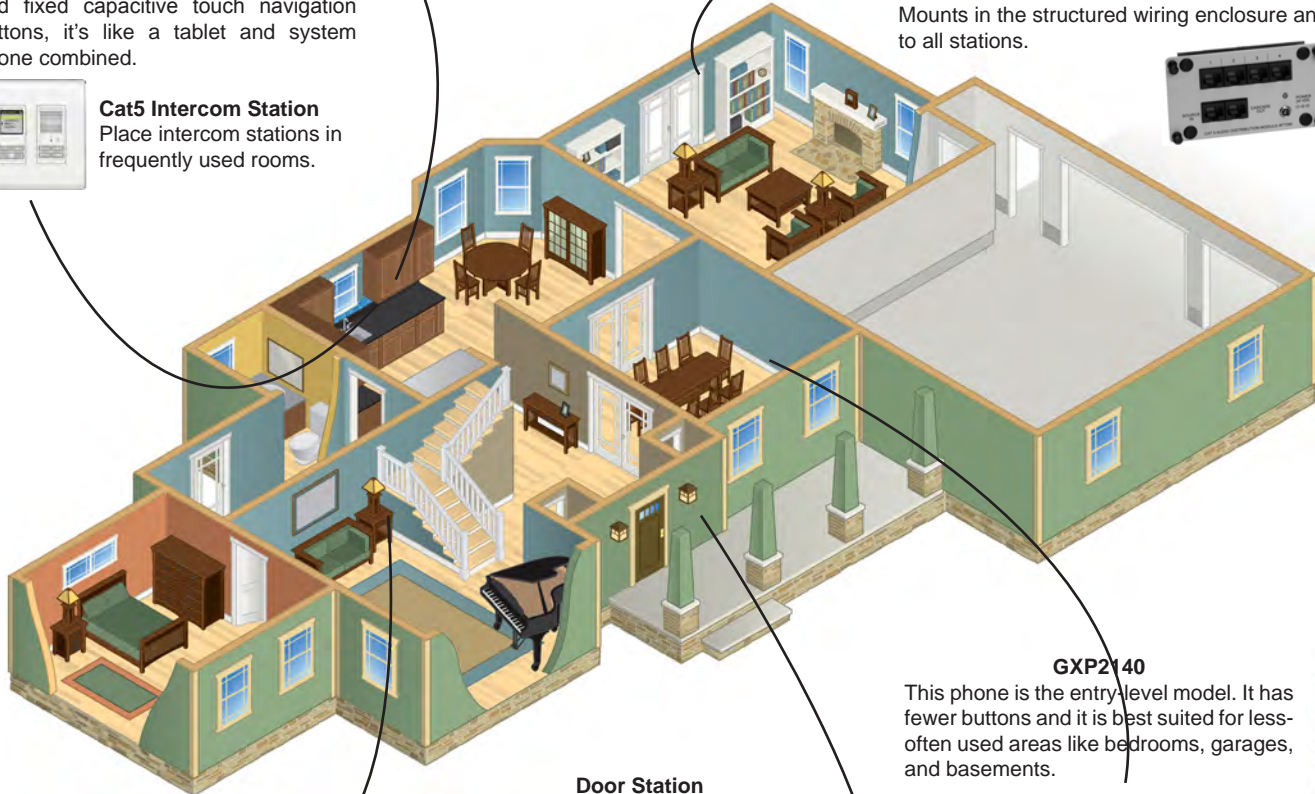

Hard Button phones

GXV3240 is the most popular of the hard button Grandstream phones. It offers plenty of configurable buttons plus a 4.3 inch touchscreen. Use these in moderately-used areas.



Door Station

On the Grandstream, a door chime tone can be played through all phones when a guest presses the button. A user inside can then answer the call and talk to the guest, and even buzz them in if door strikes are in use.



Door Station

Intercoms offer a variety of door stations. Some have cameras integrated that can be connected for inside viewing.

GXP2140

This phone is the entry level model. It has fewer buttons and it is best suited for less-often used areas like bedrooms, garages, and basements.



Cat 5 Intercom Station

Selective Call from Legrand automatically orders the room list at each station by popularity.



Pure IP telephone systems offer features of traditional digital systems with many added benefits. IP phones come in many varieties from simple to full-featured with large color touchscreen interfaces. Some even run Android to support apps. Grandstream systems show local weather data (including graphics on touchscreen models) on the phone's display. Ask us about Grandstream's IP camera lineup. Pairing them with your Grandstream IP phone systems lets users view cameras in real-time on the phone's display (select models).

IP PBX

GRAUCM6202	IPPBX, up to 150 extensions, 2 analog CO lines, 30 concurrent calls	210.47
GRAUCM6204	IPPBX, up to 150 extensions, 4 analog CO lines, 45 concurrent calls	280.63
GRAUCM6208	IPPBX, up to 150 ext., 8 analog CO lines, 60 concurrent calls, rack mount	467.71

Use Gateways Listed Below to Add More Analog CO Lines

The UCM6100 series IP PBX supports from a few users up to 150. It features full voice mail built in with no licensing fees for users or features. All set up is performed through a web-based portal and can be done locally or remotely.



SIP-DECT Wireless Phones



GRADP720



GRADP750
GRADP760

GRADP750	Cordless phone SIP-DECT base station, handles total of 5 GRADP720 phones, PoE powered	33.78
GRADP720	SIP-DECT Cordless Phone, color display, HD audio, charging cradle included	36.38
GRADP760	DECT extender, extends up to 2 calls 150' indoors	78.65

Grandstream's SIP-DECT cordless phones use the robust DECT 1.9GHz wireless technology to communicate from the DP720 phones to the DP750 base and standard SIP communication from the base to the PBX. Each DP750 base can support up to five DP720 phones. This system provides an approximate range of 150' indoors.

SIP-DECT Multi-Cell Wireless Phones

SNOM700	SIP-DECT Multi-Cell Base Station, up to 40 base stations and 200 M25 or M65 handsets per system, ~150' indoor range, PoE-powered	315.51
SNOM25	Basic Multi-Cell Handset, 1.4" TFT display, 75 hr standby	94.54
SNOM65	Premium Multi-Cell Handset, 2" backlit display, tri-color LED indicator, HD audio, 250 hr standby	185.81

Snom is a German company known for high-quality IP telephony products. Their SIP-DECT wireless phones are the perfect choice when a large number of wireless phones are required or a large area needs to be covered. One system can have up to 40 base stations and 200 handsets. The phones use DECT wireless to the bases where the call is converted to SIP and handed to the IPPBX. Multi-Cell means a phone can hop from base to base as it moves - just like your cell phone hops from tower to tower as you drive. That's how this system can cover large areas. You can even place base stations in multiple buildings so the user can carry one cordless phone across an entire campus or estate.



SNOM700



SNOM25



SNOM65

Video Door Station and OmniTouch 7



See page 182 for IP video door intercom stations. They connect to the Grandstream PBX just like a phone and can be set to dial a group of phones.

Grandstream PBXs can also be used to enable the intercom feature of the Leviton OmniTouch 7.



Analog CO Gateways

GRAGXW4104	FXO Gateway, adds up to 4 CO lines to a UCM6100 series PBX	164.45
GRAGXW4108	FXO Gateway, adds up to 8 CO lines to a UCM6100 series PBX	227.36



GRAGXW4104

Endpoints - IP Phones - Android Powered

Grandstream Android phones offer the latest in IP communication. The Android OS allows users to install any app from Google Play. It turns the phone into a full controller for any automation system. We have used apps from Leviton, Speco, EverFocus, Lutron, Russound, Vera, and more, they look great. Both models are PoE and feature dual switched network ports.

GRAGXV3275	Android Powered, 7" color touchscreen, capacitive touch dedicated nav buttons, HD audio, Bluetooth, built-in front-facing cam	180.59
GRAGXV3240	Android Powered, 4.3" color touchscreen, standard push buttons, HD audio, Bluetooth, built-in front-facing cam	148.11



GRAGXV3275
Showing SnapLink Mobile



GRAGXV3275
Customized Home Screen



GRAGXV3240
Showing Grandstream Camera



GRAGXV3240
Customized Home Screen

Endpoints - IP Phones

Grandstream IP phones feature modern convenience. They are PoE-powered and feature dual switched network ports. Weather info and forecast are displayed on all phones.

GRAGXP2170	4 programmable keys on display, 48 on-screen customizable BLF keys, 4.3" color LCD screen, HD audio, Bluetooth	93.54
GRAGXP2160	6 programmable keys on display, 24 labeled programmable keys, 4.3" color LCD screen, HD audio, Bluetooth	93.54
GRAGXP2140	4 programmable keys on display, 4.3" color LCD screen, HD audio, Bluetooth	80.55
GRAGXP2130	3 programmable keys on display, 6 labeled programmable keys, 2.8" color LCD screen, HD audio	66.26
GRAGXP1610	3 programmable keys on display, monochrome LCD	25.98
GRAGXP2200EXT	Expansion module for GXP2130 and GXP2140, adds 24 programmable keys, LCD screen in place of paper labels	85.84



GRAGXP2130



GRAGXP2170



GRAGXP2160

IP Conference Phone

The GAC2500 conference phone is a great addition to the Grandstream system and is a great fit in any conference room. Its 4.3" touchscreen and Android operating system make it easy to use - anyone who has used a smartphone will be familiar with it. Android means it can also run conferencing apps like Skype and Google Hangouts. Built-in Bluetooth allows users to sync headsets and mobile devices.

GRAGAC2500	Android-Powered Enterprise Conference Phone, PoE powered, 4.3" color touchscreen, 3 cardioid mics for 12' pickup distance in any direction, HD audio	271.53
------------	------------------------------------------------------------------------------------------------------------------------------------------------------	--------



IP Paging Module

Paging is an important part of many phone systems. The Snom PA1 paging module connects and registers to your Grandstream system like any other extension. Users simply dial its extension, announce their message, and hang up, then the PA1 plays the announcement. Use the programmable buttons on your phones to enable 1-touch paging. Add multiple PA1 for multi-zone paging.

SNOPA1	SIP Paging Module, PoE-powered, 4 watt amplifier, line outputs	138.38
SNOPA1PSU	Power supply, use when PoE is not available	18.68





Leviton's new IP Door Intercom Station is a great addition to the Omni system when OmniTouch 7 screens are in use, but it can also be used with a Grandstream or other SIP-based IP phone system. Simply configure the door station to dial a specific extension group when the call button is pressed. The built-in relay can be triggered by dialing a code when connected. It can be used to release a door strike, mag lock, or gate. The door station also features a built-in LED light for better nighttime video.



- Use with or without Leviton Omni system
- PoE powered
- SIP compliant
- Built-in relay to operate door strike/mag lock/gate
- LED lights up the subject in the dark
- Tamper alarm sounds if mounting hardware is compromised

LSAINDS1-S	IP Door Intercom Station	498.60
LSA90A00-1	PoE Injector	49.01
LUXXFS-1084P	8-port Switch, 4 ports PoE	70.43
LUXXFS-1816P	18-port Switch, 16 ports PoE+	337.23



The Teleport is a SIP video door station. It features a durable door unit with camera and a separate indoor controller. Since it follows the SIP protocol, it can be registered to a Grandstream system like any other IP phone. You program it to dial an extension or group when the button is pressed. It then rings those phones and when using Grandstream's Android phones you even see the person at the door. To take it to the next level, install a SIP app on a smartphone and register it to the Grandstream as well. You can set it so that the system phones ring a few times and if unanswered, the smartphone rings. Answer the call there and get video too!

If you need a doorbell that calls a smartphone without an IP PBX in the mix, use the Teleport no-charge cloud service. The free Teleport app is available for iOS and Android.



LGXTPC

LGXTP202XVC

- Connects to Grandstream like an extension
- Rings a selected group of phones when button is pressed
- Use Grandstream Android phones to see live video of door when answered
- Load SIP app on smartphones and have them ring if not answered inside and also view live video from the door

Also great for gates. A contact closure can be activated by dialing a user-defined code to open the gate.

LGXTPC	Teleport controller only, must use one of below door stations	389.33
LGXTP202XVC	Surface-mount IP video door station with Panning Camera (requires LGXTPC)	200.64
LGXTPEF*VC	Elite series flush door station (req. LGXTPC)	466.46
LGXBXR300EVC	Backbox, required for above door station	30.53

* AB-Antique Brass, AN-Antique Nickel, B-Bronze, OR-Oil Rubbed, C-Copper, ORB-Oil Rubbed Bronze, PB-Polished Brass, SB-Satin Brass

Use with Grandstream's IP PBX and Android-Powered Phones - Door Station Rings Phones and Shows Video

On-Hold Plus™
on-hold audio products that mean business

OHP 8000 Features:

- Ready to go right out of the box. Pre-loaded with nearly 3 hours of fully licensed music and messages
- Free on-hold production personalization provided automatically when product is registered
- Rugged extruded aluminum enclosure with wall mounting capability
- 128MB USB flash drive included (preloaded with music and "thanks for holding" messages)
- Works with any ordinary USB Flash drive
- Built-in monitoring speaker
- Trigger switch input
- MessageStudio On-Hold Audio Creator Software
- 3-Year warranty

MessageStudio Software

With the included MessageStudio, you're just a few mouse clicks away from your own, professional-sounding, custom on-hold audio presentation.



ITOHP8000	USB Music On-Hold Player, works with most phone systems, great attachment item on phone system jobs	171.11
-----------	-----------------------------------------------------------------------------------------------------	--------

Visto Door Entry Systems

The best solution for users who have strong WiFi signal to the front door.

The Visto WiFi draws power from the two wires from the existing doorbell and the power supply connected to it. It will then send the data and communication signal over WiFi to connect to your mobile device for easy communication.

A strong WiFi signal outside the door and an internet connection is all that is required.

CYXKITVISTOB	Wi-Fi Visto Kit - Black; Smart doorbell which allows audio/video communication from the door to the smartphone/tablet	194.84
--------------	-----------------------------------------------------------------------------------------------------------------------	--------

Visto Features

- Recurring revenue program for the dealers when their customers sign up for the cloud-based storage.
- Needs 2 conductor only for power, AC or DC voltage.
- Portal for dealers to monitor sites
- Motion activation capability
- Built in door release
- Cloud based storage
- Works on wifi
- 1080P Video

Coming later this year, Visto 2.

Hardwired door station so there is no concern with Wi-Fi issues. Uses the 2-wire already in place for the doorbell. Additional accessories coming later.



Video Entry Systems with Monitors

HFX-7000M: Single-family kit: Quadra and mini-handfree

- Up to 4 Doors
- Up to 4 inside stations 4.3" wide screen
- Door Station can have 1,2,3,4 buttons out of the box.
- Use in Single, double, triple, or quad family home.
- True 2-wire, no additional power needed

HFX-9000M: Single-family kit with Quadra and 7" monitor

- Up to 4 Doors
- Up to 8 inside stations 7" wide Maxi monitor screen
- Door Station can have 1,2,3,4 buttons out of the box.
- Use in single, double, triple, or quad family home.
- True 2-wire, no additional power needed

HFX-7000MW

- Wi-Fi station allows smart phone app on 2-wire system
- Up to 15 apps per apartment
- Up to 4 Doors
- Up to 4 inside 4.3" stations, you can use either non-Wi-Fi monitors or use Wi-Fi monitors for better coverage.

8531 – IP kit with Icona monitor & Wi-Fi app

- Fully IP kit, cat5 required
- Unlimited expandability
- Smartphone app included, up to 15 apps
- Monitor and door station included
- Optional surface box part number is 3116/1
- Point to point internal communication
- Unlimited communication at the same time

8513HIM – VIP kit with Wi-Fi 3G/4G remote app only

- True IP based system
- RJ45 connections to PoE switches.
- Unlimited capability and expandability, NO LIMIT.
- Smartphone apps, 15 per tenant.
- Ability to call phone numbers through SIP
- Can work in buildings if you decided to install apartment stations with the app OR app only with a telephone backup.
- Many more additional features such as concierge capabilities, elevator control, messaging client, cctv integration, call log server and more.

2-Wire Analog Kits

CYXHFX-7000M	Single-family kit with Quadra and mini-handfree monitor	269.78
CYXEX-7000H	Expansion Monitor for HFX-7000M kit	159.87
CYXHFX-8000M	Single-family kit with Quadra and Icona	327.24
CYXEX-8000H	Expansion Monitor for HFX-8000M kit	204.84
CYXHFX-9000M	Single-family kit with Quadra and 7" Maxi monitor	387.19
CYXEX-9000H	Expansion Monitor for HFX-9000M kit	362.21
CYXEX-DSQ	Quadra Door Station and switching kit	159.87

IP-Enabled Kits

CYXHFX-7000MW	Single-family kit with Quadra and mini-monitor w/Wi-Fi	414.67
CYXEX-7000HW	WiFi Expansion Monitor for HFX-7000MW kit	523.33
CYX8513HIM	VIP kit with Wi-Fi 3G/4G remote app only	823.09
CYX8531	IP kit with Icona monitor & Wi-Fi app	1,224.02

Expansion monitors and accessories available. Please call for details.



CYXHFX-9000M



CYXHFX-7000M



CYX8531



CYX8513HIM

Large Building Entry Systems

**Do you have a larger or custom application?
Between 1 and 1000+ apartments?
We can custom design a Comelit door entry system for you.**

DP68 IP Enabled Door Stations and Accessories

ACNCDP68*	IDoorBell Fon kit, 720p, wired or wireless network. Supports live video and full-duplex audio, door control. *Available in S-Aluminum, BZ-Bronze and BK-Black	186.10
ACNCDP68CBA	Baby room monitor camera. White astronaut.	68.70
ACNCDP68CID	Indoor camera, 720p, wired or wireless network	53.71
ACNCDP68COD	Outdoor camera, 720p, wired or wireless network, temperature range -4F to 135F	61.20
ACNCDP68CLB	IDoorBell Panoramic Video Light Bulb	68.70
ACNCDP68DTA	Wireless 110V powered chime for use with DP68 station	14.99
ACNCDP68DTD	Wireless battery powered chime for use with DP68 station	14.99



ACNCDP68S



ACNCDP68CID



ACNCDP68CLB



ACNCDP68COD



ACNCDP68CBA

All DP68 products work with the “yousee” App available for iOS and Android. Video monitoring, audio communications and lock control are available through the app.

Door Boxes and Accessories

ACNCDP28NIT	Surface-mount door box, used to add second station-Ivory	57.45
ACNCDP38NBF	Liberty style 2-gang flush-mount door box, add second station-Brass	108.66
ACNCDP38NBKF	Liberty style 2-gang flush-mount door box, add second station-Black	108.66
ACNCDP38NBZF	Liberty style 2-gang flush-mount door box, add second station-Black	108.66
ACNCDP38NSF	Liberty style 2-gang flush-mount door box, add second station-Brushed Aluminum	108.66
ACNCDP29CI	Door chime interface, used to ring existing door bell as well as phones	53.71
ACNCDP29SW/IM	Door strike controller for DoorBell system/intercom module	53.71

ACNCDP28NBF	Standard style 2-gang flush-mount door box, add second station-Brass	108.66
ACNCDP28NBKF	Standard style 2-gang flush-mount door box, add second station-Black	108.66
ACNCDP28NBZF	Standard style 2-gang flush-mount door box, add second station-Brass	108.66
ACNCDP28NSF	Standard style 2-gang flush-mount door box, add second station-Brushed Aluminum	108.66



ACNCDP38NBKF



ACNCDP38NSF



ACNCDP38NBZF



ACNCDP28NBF



ACNCDP28NBZF



ACNCDP28NSF

ACNC DoorBell Fon Door Answering System Kits

ACNCDP28IT	Surface-mount ivory door box kit. Rings up to five phones. Uses two-conductor wire already at the doorbell. Includes controller, power supply and door speaker.	156.12
ACNCDP28C	DoorBell Fon Controller Only	106.16
ACNCDP38*F	Liberty Style DoorBell Fon door answering system w/ flush-mount, use 2-gang masonry box	206.08
ACNCDP28*F	Standard Style DoorBell Fon door answering system w/ flush-mount, use 2-gang masonry box	206.08
ACNCDP38BXFS	Surface Mount backbox for flush mount stations	22.48

* = B-Solid Brass, S-Brushed Aluminum, BK-Black, BZ-Bronze

S Series Door Boxes



These super-thin door stations are designed to easily fit on door trim like a regular doorbell switch. Manufactured in sturdy aluminum, you can choose between a powder-coated black finish or a silver colored door station. Either color will provide an elegant solution for any application.

ACNCDP38NBKS	Station only - Black	66.20
ACNCDP38NSS	Station only - Silver	66.20
ACNCDP38BKS	Black Kit, station and DP28-C	166.12
ACNCDP38SS	Silver Kit, station and DP28-C	166.12

PP Series Power Units

NuTone PurePower Series Central Vacuums offer powerful and peaceful cleaning along with unmatched filtration for the cleanest indoor air, all at an affordable price.

NUPP500	Bagged PurePower series unit, up to 4000 square foot homes, use NU391 bags	319.04
NUPP600	Hybrid PurePower series unit, up to 7000 square foot homes, can be used with or without NU391 bags	434.83
NUPP650	Hybrid PurePower series unit, up to 9000 square foot homes, can be used with or without NU391 bags	578.91



NUPP500

NUPP600



NUPP650



Electrified Inlets and Rough-In Kits

NUCI358W	Electrified wall inlet valve and rough-in kit	9.37
NU326N	Existing home inlet kit	34.06

Kit includes all required hardware with 330NIV inlet, 8-inch length of Superflex tubing for your convenience, CF329 Mounting Plate, inlet frame, and tubing guard. No extra "surprise" parts to shop for.



NUCI358W

Standard Inlets and Rough-In Kits

NUCI3301RK	Single inlet rough-in kit for 330 / CI335	44.00
NUCI3303RK	Three inlet rough-in kit for 330 / CI335	60.63
NUCF329	Inlet mounting plate	2.95
NUCF372	Utility inlet	3.05
NUCF361	Mounting bracket with plaster guard	7.14

Automatic Dustpans

NUCI367W	Automatic Dustpan, "push to open" style operation.	36.02
NUCI365W	Flush Mount Automatic Dustpan, "slide to open" style operation. Usually used in kitchen islands.	41.17
NUCI366W	Automatic Dustpan Trim Plate, white only	3.56



NUCI365W



NUCI367W

Fittings and Pipe

NUCF362	Flanged ell-standard	1.57
NUCF364	Flanged tee	2.35
NUCF366	Straight flange	1.36
NUCF368	90-Degree street ell	0.70
NUCF369	45-Degree street ell	0.70
NUCF382	90-Degree sweep ell	0.66
NUCF382XS	90-Degree short socket ell	1.27
NUCF383	90-Degree tee	1.12
NUCF384	3-way ell	1.84
NUCF385	45-Degree ell	0.61
NUCF386	30-Degree ell	1.05
NUCF387	45-Degree wye	1.22
NUCF388	Stop coupling	0.37
NUCF389	End cap	1.00
NUCF367	Flex tubing, 36", each	7.01
NU392	Muffler	11.42
NUCF380	Pipe support w/wire clip	0.41
NUCI330	Exhaust vent	3.07
NUCF328	Plaster guard	1.36
NU399	Extension sleeve	3.57
NU376UL	100', 18/2 wire	36.71
NU393	Metal wall cap	15.80



NUCF367



NUCF380



NU392



NUCF388



NUCI330

Hoses, Cords, Tools and Accessories

NUCA130	Washable hose sock for 30'-32' hoses	24.71
NUCH515	Deluxe 30' current carrying hose w/ comfort grip, Frost White	176.82
NUCH615	Direct connect 30' current carrying crushproof hose w/ ergonomic swivel handle, Frost White	176.82
NUCS200	Standard tool set, includes floor/rug tool, wands, upholstery brush, dusting brush, tool caddy	68.96
NUCK135	Ratcheting wand, extendable 22"-39"	13.76
NUCS100	50' Ultra Deluxe Garage Kit. Includes: orange hose, upholstery tool, crevice tool and more	64.32
NUCT156B	Natural Bristle Hardwood Floor Tool	13.09
NUCT157B	Extra Wide Natural Bristle Hardwood Floor Tool	18.52
NUCT105	Round dusting brush w/ nylon bristles, Gray	2.31
NUCT700	Deluxe power brush, see below for wands	145.91

Use CT170 for CH520/CH620, use CT175 for CH515/CH615

NUCT170	Wand for CH520/CH620 hoses for CT700	27.02
NUCT175	Wand for CH515/CH615 hoses for CT700	27.02
NU376UL	UL Listed 18/2 wire, 100'	36.71
NU391	Pack of 3 bags, 6 gallon capacity, for use with all Advantage, Classique, and PP500 power units	5.95
NUVX3916	Pack of 3 bags, 6 gallon capacity, for use with VX475 series power units	12.73
NUVX3918	Pack of 3 bags, 8 gallon capacity, for use with VX550/VX1000 series power units	44.15
NUVX3918STD	Same as above but with HEPA filtration	11.25

Tool Kits and Garage Kits

NUCS600	Kit contains the following: CH615 hose, CT700 power brush, CT158 floor brush, CK135 ratcheting wand, CT175 ratcheting wand, CT105 dusting brush, CT106G upholstery tool, CT110 crevice tool, and CA130 hose sock	427.11
NUCS400	Air Turbine Kit, CK120 plus: turbine brush, hose, hose sock	236.71

System design questions? Worthington can help!

MAKE YOUR HOUSE A FULLY AUTOMATED CONNECTED HOME



Control and schedule from anywhere!

Z-Wave is a wireless technology that makes regular household products into smart devices that securely "talk" to each other. Jasco's Connected Home Collection allows you to control and schedule lights, pool pumps, water heaters and more from anywhere using your phone, tablet or PC. Visit www.easyzwave.com for more info.

JASCO



Twist & Mount

Twist & Mount patch panels allow installers to punch-down Cat 5e or Cat 6 cabling on component-rated commercial patch panels. The low profile of the Twist & Mount provides extra room for patch cord bend radii in the Structured Media Center.



Pages 188-192



Digital Audio System

Distributing audio from four sources to up to sixteen zones, the modular and scalable Digital Audio System fits neatly into a standard On-Q enclosure for a simple and straightforward install, while providing unprecedented source variety through access to streaming services.



Pages 193-197



Designer Enclosure Covers

Designed for Channel Vision's enclosures, the designer covers provide more space inside the enclosure and they enable increased airflow with the use of top and bottom vent holes or an optional fan kit (model C-1322).



Pages 202-203



Nose Plates

Cut a hole in the wall and install the low-voltage mounting plate bracket. Then simply pull your cables through the low-voltage mounting plate bracket and then through the recessed low-voltage cable plate.



Page 201

Wallplates

Wallplates complete your structured wiring installation and hold all the jacks in place for your wire termination. Generally 1-6 ports are available per plate.



Jacks

Jacks come in a variety of formats to allow for all types of wiring including phone, data, "F", RCA, BNC and many more.



Data Termination



Data runs are generally terminated to patch panel or a phone/data termination module. Once the data runs are terminated, you can then connect them to your router or switch. Cat 5e can support traffic up to Gigabit connectivity and is most often used. Cat 6 is becoming more popular now for "high" bandwidth applications.



Telephone



Telephone runs are terminated to a patch panel or phone/data termination module. Once the phone runs are terminated, you can connect them to your phone distribution block or to your phone system. Cat 5e has become the standard wiring to use for phone runs. You can use either 6-conductor or Cat 5e jacks to terminate on the room side.

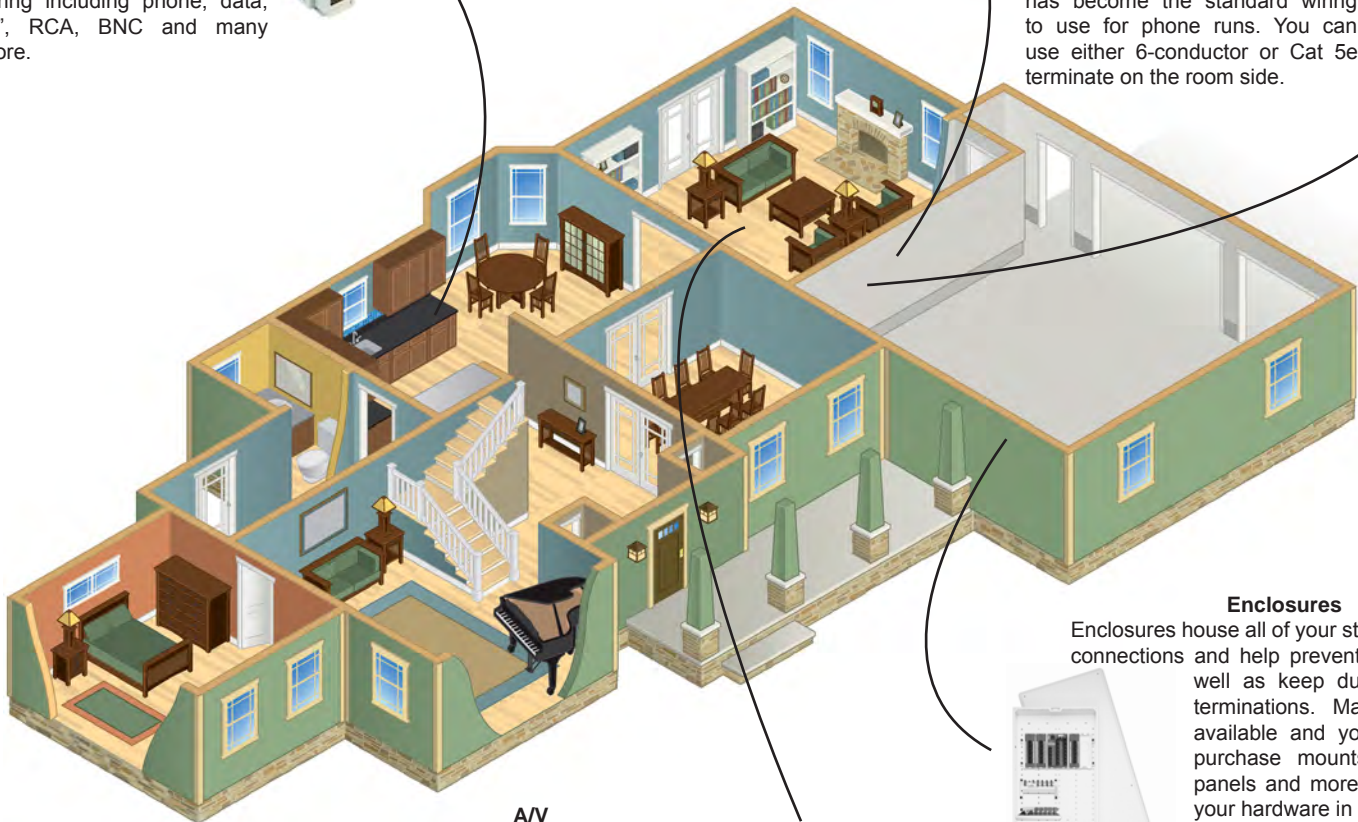

A/V

Today, you want to have as many wires to the A/V locations as possible. CATV amplifiers allow for balanced distribution to all of your rooms. You will usually also have two or more Cat 5e runs that need to be terminated for network, IR or for future-proofing your installation. Most manufacturers have jacks and plates for IR, HDMI, VGA and any type of connection that you may require.



Enclosures

Enclosures house all of your structured wiring connections and help prevent tampering as well as keep dust off of your terminations. Many sizes are available and you can usually purchase mounts for security panels and more to keep all of your hardware in one place.



Enclosure Configuration Tools



For enclosure configuration assistance, go to: leviton.com/homeconfig
 Enter the details of your installation and Leviton will provide you with a complete structured media solution.

Retrofit Enclosure



Media Versatile Panel
 The Media Versatile Panel was made for custom retrofits and remodeling. Its plywood backing and open architecture allows for simple, flexible mounting of all components. This industrial-grade panel can be surface mounted or recessed in the wall. Optional mounting brackets are available for non-standard stud spacing.



LEV47602-24E

LEV47602-BKE

Features/Benefits:

- 24" high, 18-gauge steel panel available in black powder-coat finish
- Eight 1" or 1.5" conduit knock-outs on top and bottom facilitate cable entry and routing
- Wall-mount or recess
- Securible door provides maximum protection from dust and unauthorized entry
- 3/8" plywood backing allows open architecture for customizing layout and can accommodate a wide variety of Structured Media distribution modules

LEV47602-24E	24" media versatile panel	65.56
LEV47602-BKE	Surface mount brackets for LEV47602-24E	13.39

Concrete-Mount Structured Media Enclosures

LEV48605-21E	21" concrete-mount enclosure	77.65
LEV48605-28E	28" concrete-mount enclosure*	101.04
LEV48605-42E	42" concrete-mount enclosure*	123.98

* Cover sold separately, see page 199 for options

Multi-Dwelling Unit (MDU) Enclosures

These enclosures feature the same hole patterns and benefits of Leviton's other structured media centers with the addition of extra knockouts in the top and bottom of the enclosure. These knockouts are optimized for multi-dwelling installations where multiple runs are needed. The 28" and 42" enclosures are available with two distinct hole patterns, illustrated below. All models listed come with a flush-mount screw-on cover.

MDU Configuration A

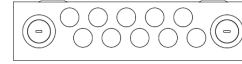

TOP

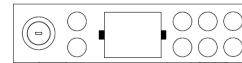

BOTTOM

MDU Configuration B

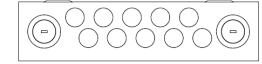

TOP

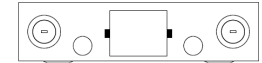

BOTTOM

*Knockout sizes support 1" & 2" commercial conduit

LEV47605-4MG	42" MDU enclosure with cover, configuration A	98.65
LEV47605-2MG	28" MDU enclosure with cover, configuration A	66.65
LEV47605-1MG	14" MDU enclosure with cover, configuration A	33.04
LEV47605-M42	42" MDU enclosure with cover, configuration B	66.65
LEV47605-M28	28" MDU enclosure with cover, configuration B	46.49

See page 210 for conduit solutions from Carlon

Compact Structured Media MDU Enclosures



LEV47605-MDU



Enclosure with Cover



LEV47604-F6S

Features/Benefits:

- Economical solution for multi-dwelling unit (MDU) connectivity
- Flexibility to accommodate a variety of telephone/video distribution configurations
- Available empty with cover or in two pre-configured kits
- Snap-on cover requires no tools or fasteners
- Molded-in brackets provide quick snap-in convenience for expansion boards
- Angled video-splitter shelf for easy installation
- Hosts three expansion boards and one TV splitter
- Constructed of sturdy white ABS molded plastic
- Listed for communications equipment (cULus listing)

LEV47605-MDU	Compact MDU enclosure only	20.18
LEV47605-MDC	Compact MDU enclosure cover only	13.31
LEV47604-F6	Compact MDU enclosure with phone module	32.57
LEV47604-F6S	Same as above with additional video module	44.91

Category Rated UTP Patch Cables (*W-White, Y-Yellow, R-Red, B-Blue, S-Grey, E-Black, G-Green)



Cat 5e		
LEV5G460-3*	Cat 5e patch cord, 3'	2.30
LEV5G460-5*	Cat 5e patch cord, 5'	2.62
LEV5G460-7*	Cat 5e patch cord, 7'	2.95
LEV5G460-15*	Cat 5e patch cord, 15'	4.48

Cat 6		
LEV62460-3*	Cat 6 patch cord, 3'	3.57
LEV62460-5*	Cat 6 patch cord, 5'	4.51
LEV62460-7*	Cat 6 patch cord, 7'	5.47
LEV62460-10*	Cat 6 patch cord, 10'	6.36



42" Enclosures and Covers

LEV47605-42W	42" enclosure with flush door	96.52
LEV47605-42N	42" enclosure only	64.55
LEV47605-F42	42" flush mount door	37.66
LEV47605-42D	42" hinged door	51.47
LEV47605-42S	42" vented hinged door	65.66

28" Enclosures and Covers

LEV47605-28W	28" enclosure with flush door	64.55
LEV47605-28N	28" enclosure only	44.39
LEV47605-F28	28" flush mount door	21.52
LEV47605-28D	28" hinged door	38.13
LEV47605-28S	28" vented hinged door	48.24

14" Enclosures and Covers

LEV47605-140	14" enclosure with flush door	30.94
LEV47605-14E	14" enclosure only	23.41
LEV47605-14C	14" flush mount door	16.14
LEV47605-14D	14" hinged door	28.24
LEV47605-14S	14" vented hinged door	33.64

Enclosure Power Options



LEV48212-6S	Surge protected, 6-outlet	80.44
LEV47605-DP	Surge protected, 4-outlet	62.38
LEV47605-NDP	Non-surge protected, 4-outlet	33.19
LEV47605-ACS	Surge protected, 2-outlet	23.13
LEV47605-ACN	Non-surge protected, 2-outlet	10.05
LEV47605-PSA	12VDC 9 plug power supply with 1 AC outlet	142.07
LEV47605-PSB	Mini 12VDC 3 plug power supply	68.57
LEV47605-PSC	12VDC 6 plug and 2 AC receptacle	136.74

Enclosure Bracket Options

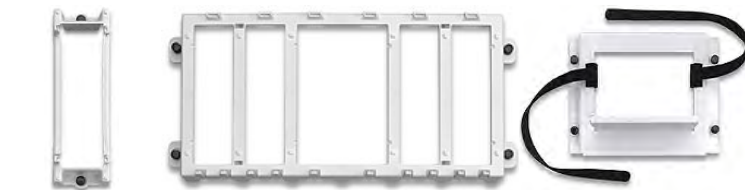

LEV47612-SBK	Single module mounting bracket	16.14
LEV47612-EBK	Full size expansion bracket	26.28
LEV47612-HBK	Half size 3 module mounting bracket	20.11
LEV47612-DBK	Data bracket for modem/router/switch	20.11
LEV47612-6SB	6" universal security bracket	20.11
LEV47612-1SB	12" universal security bracket	33.51
LEV47612-UBK	Universal battery bracket	26.82
LEV47612-HSB	Half width 6" universal security plate	17.41
LEV47612-FSB	Full width 12" universal security plate	22.78

What's In Today's Structured Wiring Panel?

It's true, end-users are no longer reliant on telephone service from their phone company, and digital cable doesn't usually work with coaxial splitters. This has led many installers to think that they don't need to install a structured wiring enclosure. Even without needing a place to run phone lines, there's still a lot of copper being run through a modern home's walls and you still need a place to terminate those wires. Leviton provides the best, most customizable options for structured wiring.

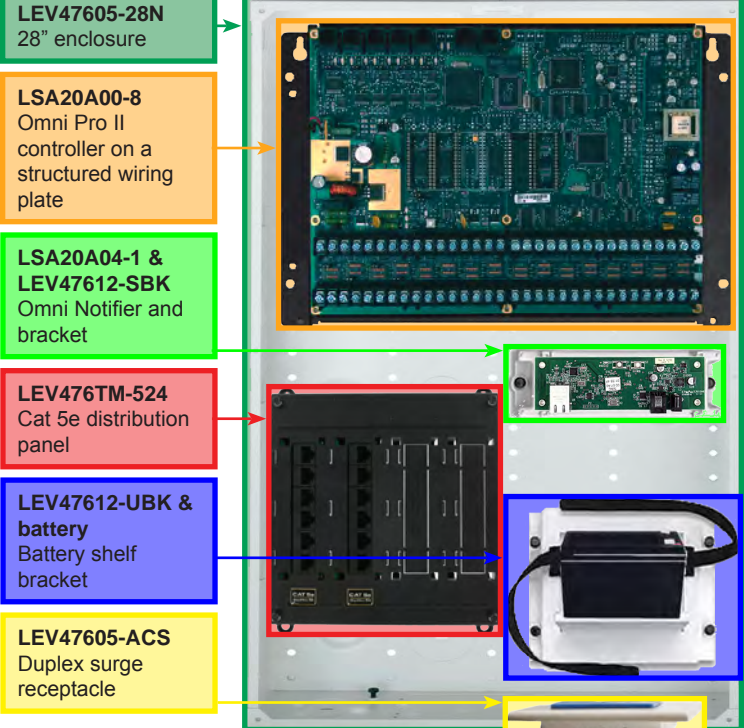

Not Pictured:

- Cover for enclosure
- 24VAC transformer for Omni Pro II
- Interconnect cables

RF Transparent Enclosure

Leviton's RF Transparent Structured Media Enclosure is designed to be used for any wireless home network. The enclosure is 30" in height and includes a vented hinged door. The enclosure expands the reach of wireless signals using ABS polymer construction to diminish interference.

- Ideal for:**
- Z-Wave
 - ZigBee
 - Wi-Fi
 - Wireless security receivers



LEV49605-30W RF transparent structured media enclosure 99.70

Enclosure Accessories

LEV5L000-L0K	Lock kit for hinged door	7.92
LEV47612-28B	Extender bracket for 28" enclosures	38.47
LEV47612-42B	Extender bracket for 42" enclosures	41.94

Extender Bracket Benefits

- Adds 2 Inch Depth
- Adds Wire Management
- Adds Ventilation
- Allows Larger Modules
- Available for 28" and 42" enclosures



Twist and Mount Patch Panels



LEV476TM-624



LEV476TM-512

Twist & Mount Patch Panels Features and Benefits:

- Low-profile, high-density, component-rated patching for both voice and gigabit ethernet connections
- Simple twist and mount installation
- Offered in Cat 6, Cat 5e, and combination Cat 6/Cat 5e configurations
- Universal T568A and T568B wiring labels ensure compatibility in both residential and commercial installations
- Manufactured from black ABS plastic
- Meet or exceed all TIA-568-C.2 bend radius requirements
- Available in 12- and 24-port versions

LEV476TM-524	24-port Cat 5e twist & mount module	105.24
LEV476TM-624	24-port Cat 6 twist & mount module	152.40
LEV476TM-654	24-port dual Cat 5e/Cat 6 twist & mount module	128.82
LEV476TM-512	12-port Cat 5e twist & mount module	64.09
LEV476TM-612	12-port Cat 6 twist & mount module	77.45
LEV476TM-652	12-port dual Cat 5e/Cat 6 twist & mount module	70.77
LEV476TM-EX5	Cat 5e twist & mount expansion board	26.32
LEV476TM-EX6	Cat 6 twist & mount expansion board	38.09

Pre-Configured Structured Media Panels



LEV47606-BTV

LEV47606-BNP

LEV47606-AHT



LEV47606-ASO

LEV47603-12P

LEV47603-18P



LEV47603-24P

LEV47603-12M

LEV47603-18M

LEV47606-BTV	4x9 phone and 1x6 video	52.80
LEV47606-BNP	4x6 phone and 1x6 2ghz video	77.76
LEV47606-AHT	Phone board, 6-port patch, and 1x6 video	97.17
LEV47606-ASO	Phone board, 12-port patch, and 1x6 video	119.89
LEV47603-12P	12-port voice/data distribution panel	123.20
LEV47603-18P	18-port voice/data distribution panel	146.40
LEV47603-24P	24-port voice/data distribution panel	168.85
LEV47603-12M	12-port 4 phone line distribution	41.83
LEV47603-18M	18-port 4 phone line distribution	60.73
LEV47603-8C1	Same as above with 6-port patch	78.42

Router and Switches



LEV47611-WG4



LEV47611-5PT



LEV47611-8GB

Wireless Gigabit Router Features and Benefits:

- IEEE 802.11a/b/g/n dual band (2.4GHz & 5GHz simultaneous) wireless technology capable up to 300+300 Mbps data rate
- Advanced security: 64/128-bit WEP, WPA/WPA2 and WPA-PSK/WPA2-PSK (TKIP/AES encryption)
- Supports Wi-Fi® Protected setup (WPS), NAT firewall, IP/port/URL-based access control, and MAC address filtering
- 1 WAN and 4 LAN RJ-45 ports
- Supports dual-SSID to access different networks through a single AP
- Supports NTP, Virtual Server, UPnP, and DMZ f

LEV47611-WG4	Wireless gigabit router	96.36
LEV47611-5PT	10/100 5-port switch	28.64
LEV47611-8GB	10/100/1000 8-port switch	82.51

Stand-Alone Modules with Brackets



LEV47605-C5B

LEV47609-TSV

LEV47616-DSB

LEV47689-B

LEV47605-C5B	6-port Cat 5e patch board on bracket	23.11
LEV47611-C6B	6-port Cat 6 patch board on bracket	34.10
LEV47609-TSV	4x6 phone with RJ31X jack on bracket	38.93
LEV47616-DSB	DSL filter board on bracket	36.15
LEV47689-B	4x9 bridged 110 board on bracket	22.87

Half-Width Pre-Configured Media Panels



LEV47603-TSV



LEV47603-DP6

LEV47603-TSV	4x6 phone with RJ31x and 1x8 video	53.63
LEV47603-DP6	4x4 phone, 4-port data, and 1x6 video	50.95

Leviton also offers a full line of expansion boards which are compatible with their pre-configured media panels and enclosure brackets.



Contact Worthington Distribution by phone, (800) 282-8864 or via email at sales@worthdist.com to learn more or to request a structured wiring quote.

To determine available colors: Match the listed color code letters for each wallplate or snap-in with the color wheels below.

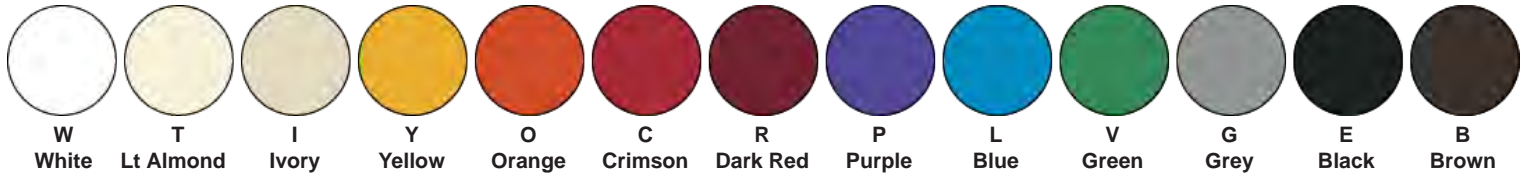

Quickport Wallplates and Decorator Inserts

LEV41642-B	LEV41643-I	LEV41644-W	LEV41646-I	LEV41080-1BP
LEV41080-2WP	LEV41080-3IP	LEV41080-4BP	LEV41080-6IP	
LEV41080-6*P	6-port flush-mount wallplate			1.31
LEV41080-4*P	4-port flush-mount wallplate			1.31
LEV41080-3*P	3-port flush-mount wallplate			1.31
LEV41080-2*P	2-port flush-mount wallplate			1.31
LEV41080-1*P	1-port flush-mount wallplate			1.31
LEV41081-4?P	4-port angled flush-mount wallplate			1.35
LEV41081-2?P	2-port angled flush-mount wallplate			1.35
LEV41646-*	6-port decorator insert			3.21
LEV41644-*	4-port decorator insert			3.21
LEV41643-*	3-port decorator insert			3.21
LEV41642-*	2-port decorator insert			3.21

* Available in W, T, I, G, E, and B
 ? Available in W, T, and I

Data/Voice Quickport Snap-Ins

	LEV5EHOM-R#5	Home 5e connector	2.35
	LEV61HOM-R*6	Home 6 connector	4.33
	LEV41108-R†5	Cat 5 connector	3.42
	LEV41108-R†3	Cat 3 connector	2.19
	LEV41106-RL5	6P6C USOC voice connector	2.19
	LEV41108-R†8	8P8C USOC voice connector	2.19
	LEV41106-RC6		

‡ Available in W, T, I, L, G, E, and B
 * Available in W, T, I, G, E, and B
 † Available in W, T, I, Y, O, C, R, P, B, V, G, E, and B

Audio/Video Quickport Snap-Ins

	LEV41084-B*F	Standard BNC	4.17
	LEV40832-B*	Gold-plated BNC	4.63
	LEV40839-S~S	3.5mm stereo screw terminal	7.19
	LEV41084-F*F	1GHz Standard F-connector	1.66
	LEV40831-B*	2.5GHz gold-plated F-connector	2.50
	LEV40830-B^E	RCA pass-through, black stripe	2.57
	LEV40830-B^R	RCA pass-through, red stripe	2.57
	LEV40834-^	HDMI pass-through	10.69

* Available in W, T, I, G, E, and B
 ~ Available in W and I
 ^ Available in W, T, I, and E
 (Additional configurations available, contact us for details)

Miscellaneous Quickport Snap-Ins

	LEV41084-B^	Snap-in blanks, 10 pack	1.50
	LEV40835-~	USB pass-through	8.91

^ Available in W, T, I, and E
 ~ Available in W and I

Retrofit Home Theater Solutions

QuickPlate® Tempo Wallplates

QuickPlate Tempo wallplates allow for fast, one-step installations. They feature rear wings which tighten the wallplate to the wallboard, eliminating the need for a box or mounting brackets. The wallplates are available in both a 2-port and 4-port configuration and have ID windows on the top and bottom of their faces.



LEV42090-2WS
front/rear

Solutions for last-minute changes!

Pass-Through Brush Insert

Avoid terminating cables by using a pass-through insert. It has brushes to cover the opening in the wall and fits into a decorator-style opening.



LEV41075-DBW

LEV42090-2♦S	2-port QuickPlate Tempo wallplate	2.85
LEV42090-4♦S	4-port QuickPlate Tempo wallplate	2.85
LEV41075-DBW	Single-gang pass-through decorator insert	4.11

♦ Select color W-White, T-Light Almond, I-Ivory, G-Grey, or B-Black

Installation Tools

	PT100004C	PT13007C	ICMCPLCCT-SLMR	LEV47615-PTT
PT100004C	EZ-RJ45 crimp tool			
PT100003C	50-pack of EZ-RJ45 connectors			
PT13007C	110 punchdown tool			
PT15015C	UTP cable stripping tool			
PT10500C	Coax cable stripping tool			
ICMCPLCCT-SLMR	Coax master compression tool			
ICMFNSNS6U	RG6 F-connectors, 5-pack			
ICMFNSNS59BNCU	RG59 male BNC connectors, 5-pack			
LEV47615-PTT	Palm termination tool			

Passive Audio Distribution Systems

Use either of the below solutions when you have amplified audio that you need to distribute to multiple locations.

Solution 1: Impedance Matching at the Distribution Module



LEVSGAMP



LEVSGVST-W

LEVSGAMP	6-room impedance-matching distribution module. Use with SGVST-W volume controls.	154.31
LEVSGVST-W	Transformer-free volume control	45.55
LEVSGVCK-*	Color change kit for SGVST-W	5.91

* Choose color I-Ivory, E-Black, LA-Light Almond

Solution 2: Impedance Matching at the Volume Controls



LEV48211-6A



LEVSGVSM-W

LEV48211-6A	1x6 passive audio distribution module. Use with SGVSM-W volume controls.	39.46
LEVSGVSM-W	Impedance-matching volume control	53.63
LEVSGVCK-*	Color change kit for SGVSM-W	5.91

* Choose color I-Ivory, E-Black, LA-Light Almond

Spec Grade® Speakers and Accessories



LEVSGI65-W



LEVPC55-KIT

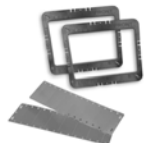

LEVAEPI6-KIT



LEVAEBC6

LEVSGC65-W	6.5" In-ceiling speaker - pair	60.46
LEVSGI65-W	6.5" In-wall speaker - pair	71.88
LEVPC55-KIT	Pre-construction kit for SGC65-W	19.91
LEVAEPI6-KIT	Pre-construction kit for SGI65-W	19.91
LEVAEBC6	Fire-rated back box for 6.5" ceiling speakers	90.13



For 5.1 and 7.1 home theater speaker solutions, check out the JBL by Leviton solutions on page 173.

Home Theater and Multi-Room Wallplates



LEVAEHTK

Home Theater Interface Wallplate

- Designed for easy installation of cables using low-voltage rings and standard low-voltage junction boxes
- Accommodates 5.1 to 7.1 channel surround-sound systems
- RCA connectors for subwoofer connection and two extra QuickPort® openings

Speaker wallplates allow simple connections to any home theater or distributed audio system.

Multi-Room Audio Wallplate

- Designed for easy installation of cables using low-voltage rings and standard low-voltage junction boxes
- Accommodates left and right audio speakers
- Two extra openings for additional QuickPort connectors (e.g., adding a subwoofer or 3.5 mm stereo phone jack)



LEVAEMRK



LEV40951-1PW



LEV40952-2PW

LEVAEHTK	Home theater interface wallplate	72.47
LEVAEMRK	Multi-room audio wallplate	25.50
LEV40951-1P*	Single spring-clip wallplate	7.54
LEV40952-2P*	Dual spring-clip wallplate	10.05

* Choose color W-White or I-Ivory

Recessed Line/Low Voltage Boxes



LEV689-W



LEV690-W



LEV47617-REB



LEV47617-RBH

LEV689-*	1-gang recessed plate/box with 15A receptacle	4.37
LEV690-*	2-gang recessed plate/box with 15A receptacle and six quickport low voltage inputs	12.00
LEV47617-REB	Recessed entertainment box. Three 1-gang knockouts for line or low voltage connections	19.38
LEV47617-RBH	Same as above with high profile cover	21.18
LEV47617-HPC	High profile cover for 47617-REB	15.87
LEV47617-LPF	Low profile cover for 47617-REB	6.77
LEV47617-PLT	Blank snap-in plate for 47617-REB	2.84

* E-Black, I-Ivory, W-White, T-Light Almond

Metal Structured Wiring Enclosures

The connected home starts in the structured wiring enclosure...

Start with a strong foundation. From rugged enclosures to high-performance outlets, wall plates, and connectors, OnQ products from Legrand guarantee a smooth installation that's designed to last.

Structured wiring solutions from Legrand simplify installations and reduce time on-site. Legrand specializes in meeting the right specifications for any residential or light commercial project with solutions that exceed your needs.

Metal Enclosures Features/Benefits:

- Flush and surface installation options
- Flanged covers hide drywall openings
- UL listed for fire and security alarm equipment
- Made in the USA
- Cable guard insert protects cables and equipment from dust, paint, and debris between rough-in and trim out
- Includes 3 powder-coated openings for cable pass-through

Enclosure Description	12" Enclosure		14" Enclosure		20" Enclosure	
Enclosure Dimensions	12.13" H x 12" W x 3.7" D		14" H x 14.25" W x 3.6"D		20" H x 14.25" W x 3.6" D	
Enclosure with Screw-On Cover	ONQEN1200	27.73	ONQEN1400	29.98	ONQEN2000	46.80
Enclosure with Hinged Cover	-	-	ONQEN1450	56.57	ONQEN2050	65.54
Enclosure Only	-	-	ONQEN1480	22.67	ONQEN2080	29.16
Screw-On Cover Only	ONQEN1220	13.33	ONQEN1420	17.36	ONQEN2020	21.18
Hinged Cover Only	-	-	ONQEN1460	33.75	ONQEN2060	39.03
Enclosure Only with Stackable Knockouts*	-	-	ONQEN1485	22.67	ONQEN2085	29.16
Enclosure Depth Extender**	-	-	-	-	-	-

Enclosure Description	28" Enclosure		42" Enclosure	
Enclosure Dimensions	28" H x 14.25" W x 3.6"D		42" H x 14.25" W x 3.6" D	
Enclosure with Screw-On Cover	ONQEN2800	62.57	ONQEN4200	93.68
Enclosure with Hinged Cover	ONQEN2850	81.81	ONQEN4250	124.90
Enclosure Only	ONQEN2880	32.66	ONQEN4280	71.19
Screw-On Cover Only	ONQEN2820	24.86	ONQEN4220	43.22
Hinged Cover Only	ONQEN2860	49.34	ONQEN4260	62.39
Enclosure Only with Stackable Knockouts*	ONQEN2885	32.66	ONQEN4285	71.19
Enclosure Depth Extender**	ONQ364450-03	36.08	ONQ364450-04	46.39



ONQEN2850

* Enclosures have five knockout locations and allow vertical alignment of two enclosures for cable pass-through
 ** Extenders add 2.5" of enclosure depth

Plastic Structured Wiring Enclosures and Modules for MDU



ONQEN0802

ONQEN0800	8" plastic MDU enclosure and cover	21.63
ONQEN0801	8" plastic MDU enclosure cover only	8.29
ONQEN0802	8" plastic MDU enclosure kit with 1x6 phone, 1x4 1GHZ video splitters	43.88
ONQEN0806	Six-pack of 8" plastic MDU enclosures and covers	116.81
ONQTM0106	1x6 phone splitter module for ONQEN0800	17.29
ONQTM0404	1x4 phone and 1x4 Cat 5e data combo splitter module for ONQEN0800	20.73
ONQVM0108	1x8 1GHZ coax video splitter module for ONQEN0800	8.19
ONQVM0208	1x8 2GHZ coax video splitter module for ONQEN0800	8.19

Power Management Solutions

Once you have a structured wiring enclosure you'll need to supply power to the modules mounted inside of it. OnQ by Legrand has a power solution for whichever configuration of AC or DC power that you'll need.



ONQPW7760



ONQPW1240

ONQPW7760	12VDC, 18W power supply	14.25
ONQPW7725	12VDC, 30W power supply	49.89
ONQPW1030	24VDC, 30W power supply	49.27
ONQPW1060	24VDC, 60W power supply	91.89
ONQPW1120	24VDC, 120W power supply kit, includes: (2) ONQPW1060, (1) ONQPW1006, velcro straps, mounting bracket	202.48
ONQPW1240	24VDC, 240W power supply kit, includes: (4) ONQPW1060, (2) ONQPW1006, velcro straps, (2) mounting brackets, and a custom power strip	385.94
ONQPW1458	48VDC, 100W power supply	41.59



ONQF7526



ONQPW1006

ONQ364569-02V1	Decora surge protected outlet kit	26.23
ONQF7526	Duplex surge protected outlet kit	8.84
ONQPW1006	Twin power supply bracket kit	9.99



ONQPW1012



ONQAC1031

ONQPW1012	Universal power distribution module	86.18
ONQPW1013	Intuity bridge power module	20.73
ONQPW1020	Digital audio power distribution module	51.22
ONQAC1031	Half-width enclosure power strip module	31.92

Structured Wiring Solutions for Builders

Legrand's OnQ structured wiring line is a perfect fit for new home construction.

Their range of wiring cans, modules, audio systems, intercoms, and automation are easy to install and most importantly, repeatable.



Video and Voice Modules



ONQCO1045



ONQCO1110

ONQ364400-04	4 coax, 6 110 voice combo module	28.30
ONQCO1045	8 coax, 10 RJ45 voice combo module*	37.16
ONQCO1110	8 coax, 10 110 voice combo module*	37.16
ONQCO2110-V1	8 coax, 10 110 voice combo module for MoCA*	40.74

* Has built-in RJ31X line seizure



ONQVM1002

ONQVM1000	1x4 enhanced passive video splitter or combiner	15.44
ONQVM1002	1x8 enhanced passive video splitter or combiner	29.41



ONQTM1045



ONQ1267062-01V1

ONQTM1110	10-way 110 voice module with RJ31X	27.99
ONQTM1045	10-way RJ45 voice module with RJ31X	31.30
ONQ1267062-01V1	6-way basic 110 voice module with RJ31X	24.91

Plastic Structured Wiring Enclosures

Constructed with a robust, wireless-transparent ABS plastic material, these lightweight enclosures are designed to integrate wireless devices into traditional structured wiring installations. The enclosures mount easily for both surface and recessed applications, and the hinged door attaches in seconds without the need for tools or a second technician.

Enclosure Description	30" Enclosure		42" Enclosure	
Enclosure Dimensions	31.75" H x 17.1" W x 5.77" D		43.5" H x 17.1" W x 5.77" D	
Enclosure with Hinged Cover	ONQENP3050	67.72	ONQENP4250	109.19
Hinged Cover Only	ONQENP3060	33.17	ONQENP4260	55.28
Hinged Cover Only {5 pack}	ONQENP3060-5	157.97	ONQENP4260-5	255.72
Enclosure Only	ONQENP3080	37.32	ONQENP4280	58.05
Enclosure Only (5 pack)	ONQENP3080-5	177.72	ONQENP4280-5	276.45

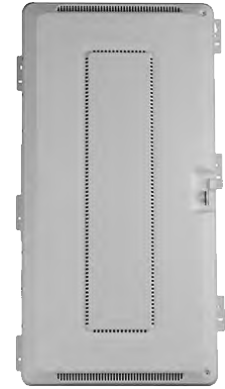

ONQENP4260

Nuvo Series Two Speakers

Impedance	Power	Woofers	Tweeter
8 ohm	50W RMS	Poly	Silk



ONQNV-2IC6



ONQNV-2IW6

ONQNV-2IC6	6.5" in-ceiling speaker	83.83
ONQNV-2IC6-ANG	6.5" angled in-ceiling speaker	58.35
ONQNV-2IC6-DVC	6.5" dual voice coil in-ceiling speaker	55.81
ONQNV-2IC8	8" in-ceiling speaker	106.76
ONQNV-2IC8-ANG	8" angled in-ceiling speaker	83.83
ONQNV-2IW6	6.5" in-wall speaker	99.12
ONQNV-2IW5-LCR	5.25" in-wall LCR speaker	76.19

Nuvo Series Six Speakers

Impedance	Power	Woofers	Tweeter
8 ohm	75W RMS	Glass Fiber	Aluminum



ONQNV-4IC6



ONQNV-4IW6

ONQNV-4IC6	6.5" in-ceiling speaker	111.86
ONQNV-4IC6-ANG	6.5" angled in-ceiling speaker	70.07
ONQNV-4IC6-DVC	6.5" dual voice coil in-ceiling speaker	83.83
ONQNV-4IC8	8" in-ceiling speaker	136.32
ONQNV-4IC8-ANG	8" angled in-ceiling speaker	83.83
ONQNV-4IW6	6.5" in-wall speaker	127.15
ONQNV-4IW5-LCR	5.25" in-wall LCR speaker	91.48

Nuvo Series Four Speakers

Impedance	Power	Woofers	Tweeter
8 ohm	100W RMS	Kevlar	Titanium



ONQNV-6IC6



ONQNV-6IW6

ONQNV-6IC6	6.5" in-ceiling speaker	152.63
ONQNV-6IC6-ANG	6.5" angled in-ceiling speaker	88.93
ONQNV-6IC8	8" in-ceiling speaker	178.11
ONQNV-6IC8-ANG	8" angled in-ceiling speaker	122.05
ONQNV-6IW6	6.5" in-wall speaker	167.92
ONQNV-6IW6-LCR	6.5" in-wall LCR speaker	134.79

Nuvo Outdoor Speakers

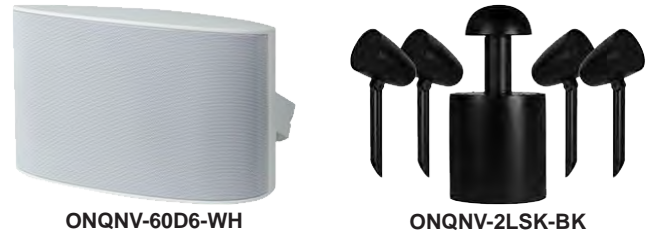

ONQNV-20D5-**	50W 5.25" outdoor speaker
ONQNV-20D6-**	50W 6.5" outdoor speaker
ONQNV-60D5-**	100W 5.25" outdoor speaker
ONQNV-60D6-**	100W 6.5" outdoor speaker
ONQNV60D5DVC**	100W 5.25" dual voice coil outdoor speaker
ONQNV60D6DVC**	100W 6.5" dual voice coil outdoor speaker
ONQNV-2LSK-BK	Landscape Speaker Kit
ONQNV2LS3SAT2BK	Additional Satellite Speakers (pair)

** Available in BK-Black or WH-White

Data Connectivity (continued)

Home Theater Straps



ONQF9004-††	2-gang 5.1 home theater strap, no wallplate	22.53
ONQF9005-††	Dual speaker strap	15.39
ONQF9006-††	Single speaker strap	5.52
ONQF9008-##-V1	2-gang 5.1 home theater strap and wallplate	20.63
ONQWP9009-††-V1	2-gang 7.1 home theater strap and wallplate	29.91
ONQWP1014-WH	Cable access strap	4.13
ONQWP1011-◆◆	HDMI plus two keystone strap	16.99

†† Available in BK, BR, IV, LA, and WH
 ## Available in BK, LA, and WH
 ◆◆ Available in LA and WH

Low Voltage Brackets

Crafted with durable heavy-duty plastic, QnQ low-voltage brackets feature an open back as well as an integrated cable management system for clean connections and easy installation.

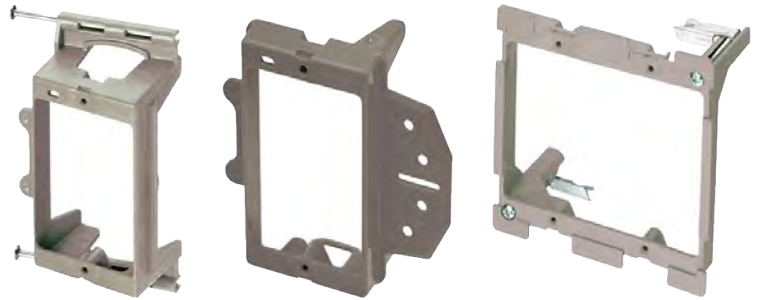

ONQAC1009-01	1-gang low voltage bracket, new construction, nail on	0.57
ONQAC1009-02	2-gang low voltage bracket, new construction, face mount	0.57
ONQAC1009-11	1-gang low voltage bracket, new construction, face mount	0.75
ONQAC1010-01	1-gang low voltage bracket, retrofit	1.01
ONQAC1010-02	2-gang low voltage bracket, retrofit	1.37
ONQAC1010-03	3-gang low voltage bracket, retrofit	1.66

Installation Tools and Connectors

Legrand helps you complete installations with speed and ease by offering tools and connectors designed to ensure accuracy, precision, and quality.

Complete any installation with confidence and incredible efficiency. Providing the tools to make quality terminations and secure connections, quickly and easily, Legrand's crimpers, strippers, testers and more help installers keep things fast, stable, and accurate.

Installation Tools



ONQ362721-02	RG6 coax stripper	22.88
ONQ363292-01	Cat 5e strip and fit tool	18.27
ONQ364406-01	RJ45 modular plug hand tool	62.19
ONQ364555-01	EZ RJ45 modular plug hand tool	62.38
ONQAC3400	Punch & Go tool for Quick Connect keystones	24.52
ONQAC3401	Replacement blade for ONQAC3400	5.40
ONQAC1018	Radial taper compression tool	108.36
ONQAC3007	Adjustable compression tool	52.13
ONQAC4006	Cable tie tool	49.06

Connectors



ONQAC3000100	100-pack RG6U/quad conical F connector ¹	41.47
ONQ364405-01	25-pack RJ45 Cat 5e plugs	10.50
ONQAC345050	50-pack EZ RJ45 Cat 5e plugs	31.10
ONQAC346025	25-pack EZ RJ45 Cat 6 plugs	17.96
ONQAC3003-10	10-pack RG6U/quad BNC connectors ²	25.90
ONQAC3006-10	10-pack F connector coupler	4.56
ONQAC3006-50	50-pack F connector coupler	20.53
ONQAC3008-10	10-pack RG6U/quad F connectors ²	7.59
ONQAC3008-50	50-pack RG6U/quad F connectors ²	33.70

¹ Use with ONQAC1018
² Use with ONQAC3007

Worthington Distribution carries Legrand's full line of OnQ products. If you don't see a product listed in our catalog please contact us for pricing and availability, (800) 282-8864 or sales@worthdist.com.



Data Connectivity

Legrand guarantees today's home technologies are easy to use and enjoy, offering connectivity components that add convenience, eliminate clutter, and boost performance.

Quality content deserves quality connections. Legrand's data connectivity products simplify use with cleaner installations and convenient access points, while maintaining the highest standard of performance. Organize wires and cables, charge devices faster, and deliver top speeds with Legrand.

COLOR KEY:

* Leave blank for brown



Keystone Decorator Straps and Wallplates



ONQWP3410 ONQWP3413-IV ONQWP3404-GY

ONQWP3410-XX	Blank decorator insert	0.51
ONQWP3411-XX	1-keystone port decorator strap ¹	0.76
ONQWP3412-XX	2-keystone port decorator strap ²	0.76
ONQWP3413-XX	3-keystone port decorator strap	0.76
ONQWP3414-XX	4-keystone port decorator strap	0.76
ONQWP3416-XX	6-keystone port decorator strap	0.76
ONQWP3401-XX	1-keystone port wall plate ³	0.70
ONQWP3402-XX	2-keystone port wall plate ⁴	0.70
ONQWP3403-XX	3-keystone port wall plate	0.70
ONQWP3404-XX	4-keystone port wall plate	0.70
ONQWP3406-XX	6-keystone port wall plate	0.70

XX Available in BK, BR, IV, LA, WH, GY, and SS

¹ LA and WH available in 10-packs, part number ONQWP3411-XX-10

² LA and WH available in 10-packs, part number ONQWP3413-XX-10

³ LA and WH available in 10-packs, part number ONQWP3401-XX-10, or in 25-packs, model ONQWP3401-XX-25

⁴ LA and WH available in 10-packs, part number ONQWP3402-XX-10, or in 25-packs, model ONQWP3402-XX-25

Audio/Video Keystones



ONQWP3481-BK ONQWP1234-IV ONQWP3457-WH

ONQWP3479-††	F connector keystone, nickel ¹	0.80
ONQWP3480-††	Recessed F connector keystone, gold	1.24
ONQWP3481-††	Recessed F connector keystone, nickel ²	1.06
ONQWP1234-??	HDMI pass-through keystone	8.37
ONQWP1215-??	3.5mm stereo pass-through keystone	4.51
ONQWP3457-??	Audio binding post keystones (pair)	4.35
ONQWP3456-??	L/R speaker keystone	2.91

†† Available in BK, BR, IV, LA, and WH

?? Available in BK, BR, LA, and WH

¹ LA and WH available in 50-packs, part number ONQWP3479-††-50

² LA and WH available in 50-packs, part number ONQWP3481-††-50

Quick Connect Voice/Data Keystone Inserts

Legrand's Quick Connect keystone inserts are designed to work with their Punch & Go installation tool, model ONQAC3400 listed on the next page. Legrand's Punch & Go tool terminates all of the wires simultaneously, which makes installations incredibly quick and easy. Alternatively, Quick Connect keystones can be terminated with any standard 110 punchdown tool.



ONQWP3473-IV ONQWP3475-BE ONQWP3476-GN

ONQWP3473-**	RJ25 6P6C Quick Connect keystone insert ¹	1.79
ONQWP3475-**	Cat 5e RJ45 Quick Connect keystone insert ²	2.21
ONQWP3476-**	Cat 6 RJ45 Quick Connect keystone insert ³	4.08

** Available in BE, BK, BR, GY, GN, IV, LA, OR, RE, WH, and YE

¹ LA and WH available in 10-packs, part number ONQWP3473-**-10

² LA and WH available in 10-packs, part number ONQWP3475-**-10. BE, LA, and WH available in 50-packs, part number ONQWP3475-**-50. WH available in 100-packs, model ONQWP3475-WH-100

³ LA and WH available in 10-packs, part number ONQWP3476-**-10. WH available in 25-packs, model ONQWP3476-WH-25

Other Voice/Data Keystone Inserts



ONQWP3425-RE ONQWP3451-WH ONQWP3560-OR

ONQWP3425-††	RJ25 6P6C keystone insert	1.76
ONQWP3450-‡‡	Cat 5e RJ45 keystone insert	2.29
ONQWP3451-^^	Cat 5e RJ45 pass-through keystone	4.51
ONQWP3460-‡‡	Cat 6 RJ45 keystone connector	4.25
ONQWP3560-‡‡	Cat 6 Snap & Go keystone connector	5.48

†† Available in BK, BR, IV, LA, and WH

‡‡ Available in BE, BK, BR, GY, IV, LA, OR, RE, and WH

^^ Available in BK and WH

Miscellaneous Keystone Inserts

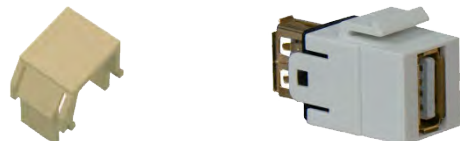

ONQWP3455-IV ONQWP1220-WH

ONQWP3455-??	10-pack of blank keystone inserts	2.16
ONQWP1220-??	USB A/A pass-through keystone insert	2.85

?? Available in BK, BR, LA, and WH

Additional keystone options are available. Contact Worthington Distribution for details, (800) 282-8864 or sales@worthdist.com



TELGUARD

Which Arlo Video System is Right for your Customer?

100% Wire-free HD Cameras

Arlo wire-free HD cameras are the perfect solutions for your customer's outdoor and indoor security needs.



Arlo Pro 2



Arlo Pro



Arlo

Mobile LTE Cameras

Arlo Go mobile LTE cameras require no Wi-Fi or AC power so you can place them where no other camera has been.



Arlo Go

WORKS WITH



HOMECONTROLFLEX

Learn more about Arlo at Telguard.com or call Telguard Sales at 1-800-229-2326, Option 5, or talk with your Worthington representative.

radiant® RF Lighting Control (RFLC)

Transform the space around you with smart lighting from Legrand.

Legrand's Lighting Control devices communicate using RF (Radio Frequency) technology. This allows seamless communication between system components and wireless control from a single app. Or forgo the app completely, and command your lights touch-free with voice-activated controls through the Google Assistant and Amazon Alexa.

ONQLC7001	Whole-House Lighting Controller (hub)	221.15
ONQLC7500-WH	RF Lighting control system starter kit*	221.15
ONQLC2101-**	In-Wall Tru-Universal RF dimmer	221.15
ONQLC2102-**	In-Wall two-wire incandescent dimmer	221.15
ONQLC2103-**	In-Wall remote RF dimmer	221.15
ONQLC2201-**	In-Wall 1500W RF switch	221.15
ONQLC2203-**	In-Wall remote RF switch	221.15
ONQLC2150	Plug-In RF Tru-Universal RF lamp module	221.15
ONQLCMRP7-W	Plug-In 800W RF small appliance module	221.15
ONQLC2303-**	In-Wall RF scene controller	234.99
ONQMR2000	2000W in-wall box incandescent dimmer	124.40
ONQMR232-G	RS232 to RF interface	124.40
ONQMRR2-G	Repeater and away emulator	20.73

* Contains: (1) LC7001, (2) LC2101-WH, (1) LC2201-WH, (1) LC2203-WH
 ** Available in WH-White, LA-Light Almond, or NI-Nickel



RFLC Sales Pieces

Looking for more information on Intuity Home Automation?



Transform the space around you with smart lighting from Legrand.



Scan the QR code above for an RFLC sales brochure.

Scan the QR code below for a video overview of RFLC.



IP Video Solutions

Allow your customers to keep a watchful eye on their home.

Providing clear, high-definition images, even in total darkness, Legrand Indoor and Outdoor IP cameras are the ideal solution for any homeowner. While at home, live camera feeds can be viewed on networked computers and devices. While away, remote access and control is convenient with the Legrand Camera or Intuity apps. All cameras install easily over a single-gang electrical box and are powered with a single PoE cable.



ONQCM7020



ONQCM7000



ONQCM7120

ONQCM7020	Indoor dome IP camera	373.20
ONQCM7000	Outdoor bullet IP camera	276.45
ONQCM7120	NVR for structured wiring enclosure	352.47

Delivering convenient room-to-room communication.

The Selective Call Intercom's high resolution LCD screens and customizable room naming offer intuitive navigation, making the system a breeze to use. Additionally, quick control for room grouping, monitoring, do not disturb, and mute options are all right at your fingertips.



ONQIC5002-OB



ONQIC5003-AB

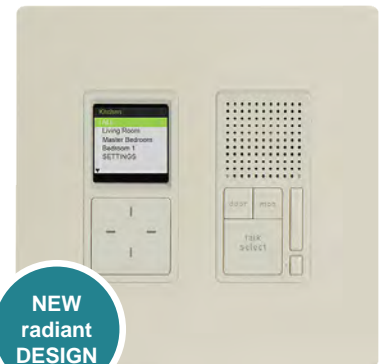

ONQIC7001-LA

NEW radiant DESIGN

ONQIC7400-**	Kit: (4) IC7001-**, (1) IC5010, (1) PW1030	912.84
** - WH-White, LA-Light Almond		
ONQIC7001-LA	Intercom room unit, light almond	199.63
ONQIC7001-NI	Intercom room unit, nickel	199.63
ONQIC7001-WH	Intercom room unit, white	199.63
ONQIC5010	Selective Call hub module	251.04
ONQIC5002-*	Intercom door unit	149.11
ONQIC5003-*	Intercom video door unit	345.75
ONQIC5006-BK	Surface-mount box for outdoor units	14.76

* Available in AB-Antique Brass, BS-Brushed Stainless, OB-Oil-Rubbed Bronze, SB-Shiny Brass, WH-White



GRANDSTREAM
CONNECTING THE WORLD

Unified Communications Solutions



Easy-to-manage and customizable set of unified communication features that centralizes an organization's communication system.



UCM6200 Series



UCM6500 Series

Recently Released GXP Phones



Innovative, high-performance IP phones built for enterprise users looking for an enhanced telephony experience with rich features & outstanding visual technology.



GXP1782



GXP2135



GXP2170

IP Video Surveillance Solutions



Complete line of IP vide surveillance solutions with rich security features that deliver reliable, uninterrupted IP technology.



GXV3674



GXV3610



GDS3710

Talk to a Worthington representative today!
(800) 282-8864



Pro-Power Kits and Media Boxes

Recessed power kits and media boxes are great for both new construction and retrofit applications where your customer wants to have a "clean" looking installation to a wall mounted TV without having wires showing.



DAT45-0024-WH



DAT45-0031-WH



DAT45-0031-WH



DAT45-0051-WH



DAT45-0023-WH

DAT45-0024-WH	Recessed Pro-Power Kit with duplex receptacle and straight blade inlet	43.65
DAT45-0023-WH	Recessed Pro Power Kit w/straight blade inlet	36.16
DAT45-0051-WH	Expandable Media Box with 15A receptacle	23.42
DAT45-0052-WH	20A version of above	32.85
DAT45-0031-WH	Recessed Low Voltage Media Plate	17.42
DAT45-0010-*	Recessed Media Box *BK-Black, WH-White	19.98

Low/Line Voltage Cable Plates



DAT45-0021

Install low-voltage cables and power behind your flat panel TV, your amplifier or other audio/video devices, flush to the wall surface.

The 45-0021 recessed low-voltage cable plate with recessed power can be installed upright or upside down.

DAT45-0021-*	Recessed w/ recessed power	13.68
DAT45-0022-WH	Kit with locking inlet	83.62
DAT45-0024-WH	Kit with straight blade inlet	43.65

*BK-Black, GY-Grey, WH-White

Keystone Plates - Standard Size

DAT20-300+*	Keystone plate, choose color and number of ports.	0.51
-------------	---------------------------------------------------	------

*AL-Almond, BK-Black, BR-Brown, GY-Gray, IV-Ivory, LA-Lt Alm., WH-White
+1-1-Port, 2-2-Port, 3-3-Port, 4-4-Port, 5-5-Port, 6-6-Port

Décor Plate Insert

DAT20-51+*	Keystone insert, choose color and number of ports.	7.49
------------	----------------------------------------------------	------

10-pack, *5-Almond, 3-Ivory, 2-White
+4-1-Port, 5-2-Port, 6-3-Port, 7-4-Port

Keystone Inserts

DAT20-3425-**	Cat 5e data jack	1.29
DAT20-3102-*	Jack w/ "F" connector, 10-pack	4.37
DAT20-3104-WH	RCA to "F," white only	1.87

* AL-Almond, IV-Ivory, LA-Lt Alm., WH-White - Other Colors Available

HDMI Décor and Keystone Inserts

DAT20-4501-WH	Decor wallplate insert with 90 degree HDMI connector	5.35	DAT20-4502-WH	Decor wallplate insert with 90 degree dual HDMI connector	10.18
DAT20-4503-WH	Standard wallplate with HDMI connector & pigtail	6.66	DAT20-4505-WH	Standard wallplate with dual HDMI connector and pigtails	10.39
DAT20-4504-WH	HDMI keystone insert	6.93			

Worthington Distribution Carries the full Datacomm line.

Décor Insert w/Flexible Opening



Install low voltage cables behind your HDTV, amplifier or other audio video devices.

Designed to be installed onto a low voltage mounting bracket (sold separately) that is installed into the wall.

DAT45-0016-BK	Décor Insert w/Flexible Opening, Black	1.87
DAT45-0016-IV	Décor Insert w/Flexible Opening, Ivory	1.87
DAT45-0016-LA	Décor Insert w/Flexible Opening, Light Almond	1.87
DAT45-0016-WH	Décor Insert w/Flexible Opening, White	1.87

Connectors, Adapters, and Splitters



BNC Female to F Male

BNC Male to F Female

Looking for CATV or CCTV adapters? Worthington has what you need. Please give us a call today!

Low Voltage Cable Plate

DAT45-0001-*	1-gang recessed	1.56
DAT45-0002-*	2-gang recessed	2.31
DAT45-0003-WH	3-gang recessed, White	4.37
DAT45-0060	5.1 surround 2-gang plate	20.98
DAT45-0008-*	Easy mount, retrofit	2.37
DAT45-0009-*	Easy mount, slim fit, retrofit	2.37

*BR-Brown, LA-Light Almond, WH-White



DAT45-0003

DAT45-0009

50" Enclosure



CVC-0150E

Enclosures include screws, grommets, wire management straps, cable identifiers & cardboard rough-in cable protector

CVC-0150E	50" enclosure only	91.93
CVC-0150D	50" smoke hinged door	135.08
CVC-0150HC	50" hinged cover only	40.97

Cover and enclosure are sold separately.

38" Enclosure

Enclosures include screws, grommets, wire mgmt straps, cable identifiers & cardboard rough-in cable protector.

CVC-0138E	38" enclosure only	62.70
CVC-0138D	38" smoke hinged door	115.62
CVC-0138HC	38" hinged cover only	30.23

Cover and enclosure are sold separately.



CVC-0138D

19" and 28" Enclosures



CVC-0119E

Enclosures include screws, grommets, wire mgmt straps, cable identifiers & cardboard rough-in cable protector.

CVC-0119C	19" cover only	9.99
CVC-0119E	19" enclosure only	31.47
CVC-0128HC	28" hinged cover only	22.23
CVC-0128E	28" enclosure only	39.97

RF Splitters



CVC-0232



CVC-0234



CVC-0314

CVC-0232	1x2 RF splitter, 5-2300MHz	9.65
CVC-0234	1x4 RF splitter, 5-2300MHz	11.02
CVC-0314	1 in 4 out splitter, DC/IR passing	29.98
CVC-0333	2 in 8 out w/ active return path, FIOS compatible	109.09
CVC-0332	1 in 16 out amp 1dB gain, DC/IR passing	68.94
CVC-0214	1x6 RJ45, 1x4 RF splitter module	27.28

Data Network Modules



CVC-0554



CVC-0538



CVC-0622



CVC-0588

CVC-0538	Cat 6 network module 8-port, 110 x 8, RJ45	38.97
CVC-0508	Cat-5e network module 8-port, 8x 110, 8x RJ45	22.98
CVC-0554	Wireless router with 4 ports - 802.11N	76.94
CVC-0575	6x6 data/patch module	14.94
CVC-0588	8-port gigabit Ethernet switch	64.95
CVC-0622	Fiber optics plate with lid and coupler	24.98

Enclosure Accessories



CVC-0408



CVC-0409



CVC-1328/29/30



CVC-1333

CVC-1351



CVC-0702



CVC-1352



CVC-1322



CVC-1324



CVC-1001



CVC-1201

CVC-0408	Cat 5e, RJ45 interconnect, 1'	1.10
CVC-0409	Cat 5e, RJ45 interconnect, 3'	1.30
CVC-1328	Mounting clips for 3/8" drywall - 4-pc/bag	2.60
CVC-1329	Mounting clips for 1/2" drywall - 4-pc/bag	2.60
CVC-1330	Mounting clips for 5/8" drywall - 4-pc/bag	2.60
CVC-1333	RJ31X module	2.50
CVC-1351	50" depth extension ring	48.50
CVC-1352	Replacement angled latch for 28" and 38"	2.20
CVC-1322	Fan kit for designer doors	19.98
CVC-1324	Universal hinge kit (3 pc)	12.43
CVC-1325	Strain relief clips, 100-pack	79.94
CVC-0702	Bracket and power strip; 6 outlets	13.99
CVC-1001	Speaker module 2 pair in x 8 pair out	49.96
CVC-1201	IR distribution, 8 in 1 out terminal strip	29.98

Telephone Distribution Modules

CVC-0410	4 CO-line surge protector module	32.97
CVC-0432	110-punch, 4x8 telephone w/ RJ31x	38.97
CVC-0436	RJ45, 4x8 telephone w/ RJ31x	27.98
CVC-0437	RJ45, 4x12 telephone w/ RJ31x	31.97
CVC-0438	4x7 locations w/110 punch downs	19.48
CVC-0439	4x15 locations w/110 punch downs	32.97
CVC-0441	110 telecom module - 100 pair w/ RJ31x	34.97
CVC-0476	1x6 telephone module	12.49



CVC-0410



CVC-0432



CVC-0436



CVC-0438



CVC-0439



CVC-0441



CVC-0437



CVC-0476

RF Modulation with Digital Cable



CVP-0328

- Easy Source Switching between Cable and Modulator
- Combines Cable TV with Modulated Signals
- Eliminates Cable Interference without Filters
- Eliminates Call Backs
- RF Amplifier Unity Gain on All Outputs

CVP-0321	2x1 Affinity module, CATV or Digital CATV in and 1 modulator input	78.94
CVP-0328	3x8 Affinity module, CATV or Digital CATV in and 2 modulator inputs, output to up to 8 locations	174.86
CVA-0511	Mini remote control for use with Affinity modules, requires IR-4101	5.00

Adapters

CV2105	Female "F" connector to male BNC connector	0.45
CV2107	Female "3-way" connector	1.50
CV2108	Female BNC "splice" connector	0.50
CV2115	Female "F" connector to male UHF connector	1.00
CV2120	2 female, 1 male BNC "T" connector	0.75
CV2123	Male BNC "right angle" connector	0.99
CV2126	Female "F" connector to RCA male connector	0.56
CV2127	Female RCA connector to BNC male connector	0.56
CV2129	Female BNC connector to RCA male connector	0.56
CV2203	Male "F" to male "F" connector "coupler"	0.75

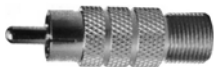

CV2126



CV2127



CV2129

iPod/iPad On-Wall Docks



CVA0604

Transform your Apple iPad® into a cost-effective wireless on-wall touchscreen panel with Channel Vision's newest On-Wall Dock. With this dock, the iPad securely mounts to the wall creating a touchscreen controller ideal for home theater, whole-house automation, security, and A/V applications. Mount your iPad horizontally or vertically and easily remove the tablet when needed for

portable use. When the iPad is removed, it becomes the perfect place to display your favorite photo.

CVA0604	On-wall dock for iPad, easily remove iPad for portable use, mounts vertically or horizontally, charges iPad (Supports devices with Lightning Connector), Black	155.88
---------	----------------------------------------------------------------------------------------------------------------------------------------------------------------	--------

The Channel Vision Wall-Dock Station for iPod for Distributed Audio supports RS-232 and IR control. The dock connector easily adjusts to fit any iPod and has a non-skid pad to help keep the music player secure. With its elegant and contemporary styling, it fits into any home setting and provides the convenience of accessing an iPod from anywhere in the home.

CVA0318	On-wall Bluetooth Audio Micro USB Docking Station for Crescendo CAT5 Audio Systems. Charge and play at the same time.	124.90
CVA0505	IR remote control for use with A-Bus systems	11.99

Accessories and Infrared Devices

CVIR-5001	All-in-one IR system, includes plasma proof IR receiver with built-in connecting block, 4 emitters	66.72
CVIR5010	Long distance plasma proof IR kit for distances up to 1000 feet	48.96
CVIR-5011	Uverse ready IR repeating kit	77.94
CVIR-2400	Remote head IR receiver, plasma proof, small footprint receiver for hidden applications	51.87
CVIR-2005	J-box IR receiver, mounts in a single gang low-voltage mud ring	53.48
CVIR-1203	Amplified IR hub, 4 emitter ports, status LEDs, screw term. or mini plug. PS included, req. emitters.	23.08
CVG-IRB-W	Snap-in insert for structured wiring plate, converts 3-conductor IR wiring to 3.5mm jack	2.25
CVIR-4500	IR over coax kit, use with Affinity modules to switch sources	58.38

CVIR5010

By keeping the IR5010 on your truck, you can stock one kit for nearly every IR application. Receiver is CFL, LCD and plasma proof and the kit includes options for surface, stick-on and recessed-mounting.



CVIR5010



CVG-IRB-W

Accessories and Infrared Devices

CVHS2	2-way splitter/combiner	4.75
CVHS3	3-way splitter/combiner	6.49
CVHS4	4-way splitter/combiner	8.47
CVHS6	6-way splitter/combiner	16.94
CVHS8	8-way splitter/combiner	19.73
CVHS16	16-way splitter/combiner	39.82



CVHS2

IP Cameras/NVR

CV6565	2MP (1080p) outdoor IP dome camera with IR, weatherproof/vandal proof, varifocal 3-10.5mm lens, PoE, analog/IP video simultaneously	247.80
CV6543	2MP (1080p) outdoor IP bullet camera with IR, weatherproof/vandal proof, varifocal 3-16mm lens, PoE, analog/IP video simultaneously	366.71
CV6533	2MP (1080p) indoor IP dome camera, 2.8mm lens, PoE, event triggered micro SD recording	168.86
CVW4001	H.264 4-channel video server, PoE	398.68
CVNVR-04N-1000	4-channel NVR, 1TB HDD	489.61
CVNVR-04N-2000	4-channel NVR, 2TB HDD	520.58



CV6533



CV6543



A smart home begins with the driveway.

The driveway is the path to a home and Cartell makes it smarter. Whether your customer is looking to see who's coming or manage who's going, our products are easy to install and integrate, and don't need much else to keep going.

Doorbells are so last season.

cartell[®]

XTL Labelers and Labels



Jobsite tested and packed with features, the DYMO® XTL™ 300 and XTL 500 label makers help simplify industrial labeling for a more efficient, frustration-free experience. By incorporating cues from today's technology, XTL label makers offer a familiarity that makes using them easy.

DM1868815

DM1868815	XTL 500 Hard Case Kit. Includes: XTL 500, Carrying Case, AC Adapter, USB Cable, Battery, (1) 2 in x 23 ft All-Purpose Vinyl-Black/White, (1) 1 ½ in x 1 9/16 in Laminated Wire/Cable Wrap-Black/White, 150 labels, Quick Start Guide, and Software Download Card.	516.36
DM1868814	XTL 300 Hard Case Kit. Includes: XTL 300, Carrying Case, AC Adapter, USB Cable, Battery, (1) 1 in x 23 ft All-Purpose Vinyl-Black/White, (1) 13/16 in x 1 9/16 in Laminated Wire/Cable Wrap-Black/White, 150 labels, Lanyard, Quick Start Guide, and Software Download Card.	309.81

RHINO 5200 Hard Case Kit



DM1756589

- "Hot Keys" instantly format wire wraps, patch panel and fixed length labels and more
- Prints Code 39 and Code 128 bar codes
- Smart on-screen alerts; 100 memory locations
- Uses RHINO labels up to 3/4" wide
- Includes RHINO 5200 printer, hard carry case, two labels (18489, 18443), AC adapter/charger and rechargeable lithium-ion battery

DM1756589	RHINO 5200 Hard Case Kit, incl. 1755749, 18489, 18443, 15519, 1760413 and rechargeable lithium-ion battery	194.88
DM1755749	RHINO 5200 printer only	138.34

RHINO 4200 Printer



DM1835374

- Easy to navigate QWERTY keyboard
- "Hot Keys" instantly format wire wraps, flags, fixed length labels and more
- Uses RHINO labels up to 3/4" wide
- Adds "Favorites" and "Custom" keys to increase labeling productivity and reduce labeling time

DM1801611	RHINO 4200 Printer	84.21
DM1835374	RHINO 4200 Printer Kit. Includes 4200 Printer, AC Adapter, Case, Labels.	146.60

Part No.	Length	Size	Color	Price
Vinyl - Use for indoor/outdoor applications, great for curved surfaces				
DM1868751	23'	1/2"	White	18.78
DM1868752	23'	3/4"	White	22.16
DM1868753	23'	1"	White	34.20
DM1868754	23'	1-1/2"	White	40.60
DM1868755	23'	2"	White	49.62
DM1868772	23'	3/4"	Yellow	22.16
DM1868762	23'	3/4"	Red	22.16

Other Vinyl Colors/Sizes available. Call for details.

Laminate Wire Wraps - Ideal for wire/cables

DM1868704	13/16"	13/16"	White	38.87
DM1868705	1-9/16"	13/16"	White	28.10
DM1868706	4"	13/16"	White	33.91

Pre-Sized Safety Labels - Color indicates Header color

DM1868715	4"	2"	Blue	35.97
DM1868716	4"	2"	Red	35.97

**Other label styles and sizes available.
Give Worthington a call today!**

RHINO Labels - Buy 4 Get 1 Free!

- Industrial-strength adhesive for labels that stick and stay stuck
- Split-back design for easy application

Part No.	Material	Size	Color	Price
Flexible Nylon - Wire/cable, flat, curved, rough or smooth surfaces				
DM18488	Flexible Nylon	1/2"	White	20.07
DM18489	Flexible Nylon	3/4"	White	22.17
DM1734524	Flexible Nylon	1"	White	24.30
DM18490	Flexible Nylon	1/2"	Yellow	20.07
DM18491	Flexible Nylon	3/4"	Yellow	22.17
DM1734525	Flexible Nylon	1"	Yellow	24.30

Vinyl - Use for indoor/outdoor applications, great for curved surfaces

DM18444	Vinyl	1/2"	White	17.09
DM18443	Vinyl	3/8"	White	16.91
DM18432	Vinyl	1/2"	Yellow	17.09
DM18433	Vinyl	3/4"	Yellow	21.03
DM1805416	Vinyl	1/2"	Red	17.09
DM1805422	Vinyl	3/4"	Red	21.03
DM1805435	Vinyl	1/2"	Black	17.09

Other Vinyl Colors/Sizes available. Call for details.

Heat Shrink Tube Cartridges

DM18051	1/4" Heat Shrink Tube - White	38.40	DM18056	1/2" Heat Shrink Tube - Yellow	44.33
DM18052	1/4" Heat Shrink Tube - Yellow	38.40	DM18057	3/4" Heat Shrink Tube - White	47.28
DM18053	3/8" Heat Shrink Tube - White	41.38	DM18058	3/4" Heat Shrink Tube - Yellow	47.28
DM18054	3/8" Heat Shrink Tube - Yellow	41.38	DM1805443	1" Heat Shrink Tube - White	63.53
DM18055	1/2" Heat Shrink Tube - White	44.33	DM1805444	1" Heat Shrink Tube - Yellow	63.53

F-Conn Universal Compression Connectors (Connectors sold in 5-packs)

F Connector			RCA Connector			BNC Connector		
ICMFSNS6U	RG6, Nickel	2.45	ICMFSNS6RCAU	RG6, Nickel	6.86	ICMFSNS6BNCU	RG6, Nickel	11.89
ICMFSNS59U	RG59, Nickel	2.45	ICMFSNS59RCAU	RG59, Nickel	6.86	ICMFSNS59BNC SL	RG59, Nickel	11.89



ICMFSNS6RCAU



ICMFSNS59BNC SL



ICMFSNS6U



ICMFSNS6BNCU

Right-Angle Connectors (Connectors sold in 5-packs)

ICMFSNS6URA	Right-angle F for RG6, Nickel	10.91
ICMFSNS59URA	Right-angle F for RG59, Nickel	10.91
ICMFSBNC6URA	Right-angle BNC for RG6, Nickel	16.16
ICMFSBNC59URA	Right-angle BNC for RG59, Nickel	16.16
ICMFSRCA59URA	Right-angle RCA for RG59, Nickel	14.23
Requires ICMLMTIP-RA tip in ICMCPLCCT-SLMR tool for compression.		

Color Bands

ICMFSCR*	Universal color bands for F, RCA, and BNC (bag of 100)	4.91
*R-Red, W-White, Y-Yellow, B-Blue, G-Green, BK-Black, O-Orange, P-Purple		

Cable Pro and F-Conn are the choice of professionals

Belden's TRUE 360° compression connectors and tools work together as a complete integrated system. One easy-to-use Cable Pro tool is able to compress a variety of F-Conn F, RCA, and BNC type connectors to fit RG59, RG6, mini coax, and a variety of plenum size cable.

Professional Compression Tools and Accessories

ICMCPLCCT-SLMR	Linear compliant compression tool, solid steel construction, includes four tips to compress nickel and gold, right angle and splice connectors in F, RCA, and BNC. Compatible with Leviton and OnQ connectors.	99.43
ICMLMTIP-RA	Tip for use with right-angle connectors in SLMR compression tools	2.67
ICMLMTIP-WP	Tip for use with wallplate snap-in connectors in SLMR compression tools	2.67
PT15030C	2-level coaxial cable stripper for RG-59/6/Mini Coax. Be sure to use the FIT6 Flaring and Insertion tool for easier termination.	10.45
ICMFIT6	Flaring and Insertion tool, used to separate the cable jacket for easier installation of the F connector. Also folds back foil and braiding.	20.05
ICMCPPT-1	Pocket Toner, loud audio tone identifies line carrying signal	24.50



ICMCPLCCT-SLMR



ICMFIT6





ICMCPPT-1



PT15030C

Mini-Coax Connectors (Connectors sold in 5-packs)

	ICMFS1BNC	Mini-Coax BNC connector for 25-26ga wire. Great for component video. Orange.	11.68
	ICMFS1RCA	Mini-Coax RCA connector for 25-26ga wire. Great for component video. Orange.	9.37
	ICMFSNS15BNC	Mini-Coax BNC connector for 22-24ga wire. Great for component video. Purple.	11.68
	ICMFS15RCA	Mini-Coax RCA connector for 22-24ga wire. Great for component video. Purple.	9.37
	ICMFSNS15	Mini-Coax "F" connector for 22-24ga wire - 5-pack.	4.62
One piece connectors listed, call for multi-piece connectors.			

ICMFS1RCA

ICMFSNS15BNC

Why use Belden Compression Connectors?

Belden BNC, RCA and F Compression Connectors exceed SCTE Standards for signal ingress, egress and water migration, while providing exceptional aesthetic and strength characteristics. They ensure optimal connector performance by offering:

- Visual confirmation of cable entry
- Better performance with improved signal impedance
- A simple product and installation process removes installation inconsistencies

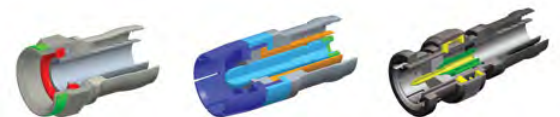

Splice Connectors (Connectors sold in 5-packs)

ICMFS6US	RG6 F splice, Nickel	5.81
ICMFS59US	RG59 F splice, Nickel	5.81
ICMFS6RCAUS	RG6 RCA splice, Nickel	7.13
ICMFS1RCASST	25-26ga Mini-Coax RCA splice, Nickel	11.68
ICMFS15RCASST	22-24ga Mini-Coax RCA splice, Nickel	11.68
ICMFS6BNCUS	RG6 BNC splice, Nickel	11.89
ICMFS59BNCUS	RG59 BNC splice, Nickel	11.89
ICMFS1BNCSSST	25-26ga Mini-Coax BNC splice, Nickel, 6pk	11.75
ICMFS15BNCSSST	22-24ga Mini-Coax BNC splice, Nickel, 6pk	12.96

Splice connectors give maximum flexibility in creating custom wiring installations.

Insert Modules (Universal insert for structured wiring, priced each)

HIPUAM	Use with splice connectors, Almond	0.06
HIPUIM	Use with splice connectors, Ivory	0.06
HIPUKM	Use with splice connectors, Black	0.06
HIPULAM	Use with splice connectors, Lt. Alm.	0.06
HIPUWM	Use with splice connectors, White	0.06

Color O-Rings (Use with RCA/BNC splices, priced in 100 bag)

HIPOB	Blue, specifies insert as the Blue channel of an RGB connection	2.50
HIPOG	Green, specifies insert as the Green channel of an RGB connection	2.50
HIPOK	Black, specifies insert as the Black channel of an RGB connection or as the left channel of Line Level Audio	2.50
HIPOO	Orange, specifies insert as a Digital Coaxial Audio connection	2.50
HIPOP	Purple, specifies insert as a Subwoofer connection	2.50
HIPOR	Red, specifies insert as the Red channel of an RGB connection or as the left channel of Line Level Audio	2.50
HIPOW	White, specifies insert as the right channel of Line Level Audio	2.50
HIPOY	Yellow, specifies insert as a Composite Video connection	2.50



ICMFS6US

Create a Splice (Follow these three steps to create a complete unit)

1.) Choose a splice

- "F", RCA or BNC
- RG6, RG59 or Mini-Coax
- Nickel or Gold



2.) Choose an insert module

- Almond or Light Almond
- Ivory
- White or Black



3.) Add Color O-Rings

- HIP rings for splices
- ICM bands for connectors
- Call with any questions

Coaxial Wire

WAVH59182NVRBK3	18/2 + RG59 Siamese wire, 500' roll with Black jacket	52.46
WAVRG6URBK1	RG6, 60% shield, 3.0GHz rated, 1000' box with Black jacket	46.21
WAVRG6QRWH	RG6, Quad shield, 3.0GHz rated, 1000' box with White jacket	57.45

Worthington carries many other types of wire. Give us a call today!

Starter Kits

ICMSTARTERKIT	Universal starter kit, selection of tools, connectors, color bands, inserts and more	232.85
ICMSLMPSAKIT	Basic starter kit, includes ICMCPLCCT-SLM and PSA59/6 strip tool	108.08
ICMDBPSAKIT	Double Bubble starter kit, includes Double Bubble compression tool and stripper	120.95
ICMDBSTARTER	Double Bubble starter kit, includes compression tool, stripper and a selection of assorted connectors	228.97

Double Bubble 360 Tools and Connectors (Connectors sold in 5-packs)

ICMCPLCRBC-BR	Double Bubble Compression Tool-Blue	93.79
---------------	-------------------------------------	-------



ICMCPLCRBC-BR



ICM Double Bubble Connectors, F, RCA, BNC

ICMDB6U	F connector for RG6	1.68
ICMDB6PL2	F connector for RG6 Plenum	2.54
ICMDB6RCAU	RCA connector for RG6	5.95
ICMDB6RCAPL2	RCA connector for RG6 Plenum	5.77
ICMDB6BNCU	BNC connector for RG6	9.37
ICMDB6BNCHD	HD BNC connector for RG6	10.14
ICMDB6BNCPL2	BNC connector for RG6 Plenum	10.48
ICMDB59U	F connector for RG59	1.75
ICMDB59PL2/4	F connector for RG59 Plenum	2.34
ICMDB59RCAU	RCA connector for RG59	5.95
ICMDB59BNCU	BNC connector for RG59	9.37
ICMDB59BNCPL2/4	BNC connector for RG59 Plenum	9.37

Category Wire (UTP) Termination



PT100054C



PT100003C



PT15015

PT100008	EZ-RJ-45 Combo 24, includes crimp tool and 24 Cat 5/5e connectors	57.33
PT100004C	EZ-RJ-45 crimp tool	49.42
PT100054C	EZ-RJ-45 heavy duty professional crimp tool for Cat 5/5e, Cat 6 and RJ-11/12 connectors	67.43
PT100003C	EZ-RJ-45 Cat 5/5e connectors, 50 pieces	24.79
PT100010C	EZ-RJ-45 Cat 6+ connectors, 50 pieces	28.02
PT100022	EZ-RJ45 Shielded Cat5e/6, (External Ground), 50 pieces	70.18
PT100026C	EZ-RJ12/11 connectors, 50-piece clamshell, use with EZ-RJPRO crimp tool	14.05
PT202035J	Strain relief for Cat 5/5e EZ-RJ-45 connectors, 100 piece jar	19.41
PT202036J	Strain relief for Cat 6 EZ-RJ-45 connectors, 100 piece jar	19.41
PT13032C	Replacement NeverDull 66 style blade for 13006C	11.95
PT13033C	Replacement NeverDull 110 style blade for 13006C	11.95
PT13155C	Pro-Strike Punchdown impact tool w/ 110 blade	37.43
PT13159C	Pro-Strike Punchdown impact tool w/ 110 and 66 blades	37.43
PT15015C	Cat 5 cable jacket stripper	8.96
PT13501C	Xpress Jack, jack termination tool.	59.91

Miscellaneous Tools/Connectors



PT15003C



PT10514C



PT15030C

PT15310	Maxim 6 self-adjusting wire stripper 24-10 AWG	56.92
PT15030C	2-level coaxial cable stripper for RG-58/59/62/6/6 Quad/Mini Coax	10.45
PT10514C	CCS-6 cable cutter	14.95
PT15003C	ProStrip 10/20 wire strippers	11.20
PT15010C	Stripper for plenum jacket, NYC code firewire, speaker wire, fiber and more	22.44
PT12100	Connector pressing telecom pliers, use with model 18110 connectors	11.22
PT19101	33-piece precision screwdriver set	15.70
PT13022	Punchdown tool extension (66 and 110), great for structured wiring punchdowns	13.45
PT13021	66/110 combo blade, cutting blade for 66 and 110 blocks	10.45
PTTP150	Tone and probe set, includes a carrying case, 9V batteries and user instructions	24.32
PT90170	10Gig termination kit	179.86
PT90173	EZ-RJPRO Termination Pod	213.58
PT12507C	Tele-Titan Modular Plug Crimp Tool	26.19
PT18110	Telcom Splicing Connectors, use 12100 pliers	0.12



PTTP150



PT90170

EZ-SnapJacks (Connectors sold in 10-packs)

PT705*-1 Cat 5/5e, bulk, bagged, 10-pack 29.85

*AL-Almond, BK-Black, BL-Blue, BR-Brown, GN-Green, IV-Ivory, LA-Light Almond, OR-Orange, RD-Red, WH-White or YL-Yellow

PT706**-1 Cat 6, bulk, bagged, 10-pack 32.47

**AL-Almond, BK-Black, BL-Blue, BR-Brown, GN-Green, IV-Ivory, LA-Light Almond, OR-Orange, RD-Red, WH-White or YL-Yellow



EZ-SnapJacks

First the EZ-RJ45®, now the EZ-SnapJack! You may never again need a punchdown tool. At least for your wall jacks! The patented EZ-SnapJack is self-terminating and quickly installs for professional results in a snap.

- Save time – No need for eight punch downs
- Repair damaged jacks on the spot
- EZ-SnapJacks are reuseable
- Wire guide ensures pairs stay in proper order for fast, easy termination
- Reduced tool cost, no PDT required
- Your tool bag weighs less
- Available for Cat 5e and Cat 6
- Designed to fit industry standard wallplates
- Commercial network installations, new or retrofit
- Home automation installations, new or retrofit

Testers

PTTCB360K1 Cable Prowler PRO Test Kit 608.85



PTTCB360K1

• **Includes:** Cable Prowler main unit, #1-8 Network/Tel Test and ID Remotes, #1-8 Push on Coax Remotes, #1-12 RJ45 Data Remote set, Micro USB cable, No-Fault cable - Qty 2, RJ45 Port Saver, RJ45 to Alligator 12 inch, F Female to F Female adapters, set of 2, BNC Female to F Female adapter, BNC Female to F Male adapter, Heavy duty case

• Multilingual (English, French, Spanish)

PTT129K1 VDV MapMaster Kit 162.33

The VDV 2.0 MapMaster combines continuity testing, mapping, tone generation and length measurement functions in a single tester. This kit includes the tester and all the accessories required for voice, data and video testing & mapping in the field. It's packaged in a rugged double-walled, blow-molded case with custom cut out, high density EVA foam to help protect your equipment for years to come.



PTT129K1



Plastic Push-In Connectors for Metal Enclosures



AIINM940

Part #	Description	Box Qty.	Each Price
AIINM940	Connector for 3/8" knockout	100	0.12
AIINM95	Connector for 3/4" knockout	50	0.22
AIINM96	Connector for 1" knockout	50	0.22

Low Profile Outdoor Weatherproof Line Voltage Box



AIIDBVS1*

Part #	Description	Box Qty.	Each Price
AIIDBVS1*	New siding	4	12.46
AIIDBVM1*	Stucco	4	9.59
AIIDBVR1*	Retrofit	4	12.22
AIIDBVR131*	Retrofit siding 1/4"-5/16" lap	4	13.96
AIIDBVR141*	Retrofit siding 1/2" lap	4	13.96
AIIDBVR151*	Retrofit siding 5/8" lap	4	13.96
AIIDBVR171*	Retrofit siding dutch lap	4	13.96

*Available Covers: C-Clear, W-White



AIIDBVR131*

Outdoor Weatherproof While-In-Use Line Voltage Box



AIIDBPV1

Part #	Description	Box Qty.	Each Price
AIIDBPV1	Dri-box w/ cover, base, and wallplate, vertical, 1-gang	4	9.52
AIIDBPH1*	Same as above but horiz.	4	9.52
AIIDBP2*	Dri-box w/ cover & base w/ wallplate, vertical, 2-gang	4	16.26

*Available Covers: C-Clear, No Suffix-White

Dual Voltage Device Box



AIILVDR2

Part #	Description	Box Qty.	Each Price
AIILVD2	Power and low voltage box for new construction	25	3.05
AIILVDR2	Power and low voltage box for existing construction	25	3.90

Line Voltage Box



AIIF101



AIIF102

Part #	Description	Box Qty.	Each Price
AIIF101	1-gang for new construction	50	1.54
AIIF101F	1-gang screw-on non-metallic vapor box	25	3.11
AIIF101H	1-gang for new construction - horizontal	25	1.71
AIIF102	2-gang for new construction	25	2.34
AIIF103	3-gang for new construction	50	3.27
AIIF104	4-gang for new construction	10	5.46

In/Out Box - Adjustable Outlet Box 1/2" - 1 1/2"



AIIFA101

Part #	Description	Box Qty.	Each Price
AIIFA101	1-gang, non-metallic	25	2.26
AIIFA102	2-gang, non-metallic	10	2.91
AIIFA103	3-gang, non-metallic	10	5.18
AIIFA104	4-gang, non-metallic	1	6.48

Line Voltage Box Extenders



AIIBE1

Part #	Description	Box Qty.	Each Price
AIIBE1	1-gang for old construction	25	1.10
AIIBE1R	Round ceiling box extender for old construction	25	1.92
AIIBE2	2-gang for old construction	25	1.53
AIIBE3	3-gang for old construction	25	3.17
AIIBE4	4-gang for old construction	25	4.36

Recessed Duplex Receptacle Box



AIIDVFR1W

Part #	Description	Box Qty.	Each Price
AIIDVFR1W	1-gang with retrofit box	4	7.13
AIIDVFR2W	2-gang with retrofit box, for power or low-voltage	4	11.66

Recessed TV Box



AIITVB613



AIITVBU505



AIITVL508

Part #	Description	Box Qty.	Each Price
AIITVB613	13" wide box fits in 16" O.C. studs for horizontal or vertical installation	1	12.39
AIITVBS613	Same as above but steel	1	29.50
AIITVBU505*	2-gang - receptacle kit with retrofit line/low box, white - *BL-Black	1	9.64
AIICED130	TV box w/slotted cover	1	2.16
AIITVL508	Low-Profile TV box for shallow wall depths, great for flat TVs	1	14.80
AIITVBRA1K	1-gang TV Bridge Kit	1	44.45
AIITVBRA2K	2-gang TV Bridge Kit	1	54.68

Round Steel Countertop Box Kits with Trapdoor



Stainless



Part #	Description	Box Qty.	Each Price
AIIFLBT4465*	Standard receptacle	1	118.66
AIIFLBT4465G*	GFCI receptacle	1	133.02
AIIFLBT4465U*	Std. receptacle with USB	1	139.89

*BL-Black (Coming Soon), SS-Stainless Steel

The gasketed trapdoor cover looks great! It closes flush with the countertop, preventing water intrusion and damage to the devices in the box. Available in both Stainless Steel and Black finishes.

Square also available. Call for details.

Garden Posts

Part #	Description	Box Qty.	Each Price
AIIGP19*	19.5" post for GFCI outlet	6	23.29
AIIGP26*	26" post for GFCI outlet	6	39.31
AIIGPD19*	19.5" post for GFCI outlet w/ in-use cover	6	20.95
AIIGPBK35*	35" post with bollard light fixture	1	141.62
AIIGPD9*	9" deck mount for GFCI outlet/light fixture	1	20.96
AIIGP37*	37" post for GFCI outlet/light fixture	4	59.27
AIIGPX18*	18" extender for above post	4	31.75
AIIGPL19*	19.5" low profile post for light fixtures	6	15.87
AIIGPI75*	Up to a 75 watt flood light for posts	4	25.09
AIIGPF13*	13 watt fluorescent flood light	4	44.43
AIIGPP60*	Pagoda-style light fixture; style 1	4	26.60
AIIGPP60L*	Pagoda-style light fixture; style 2	4	29.44

*B-Black and BR-Bronze. Other Colors Available. Call for Pricing.



AIIGPI75



AIIGPF13



AIIGPP60



AIIGPP60L

Line Voltage boxes (No upcharge for broken cases)



CARB120R

		Box Qty.	Ea. Price
CARB122A-UPC	1-gang box with nails 3 1/2" depth, 22 cubic in.	100	0.86
CARB232A-UPC	2-gang box with nails 3" depth, 32 cubic in.	50	1.81
CARB455AH	4-gang box with nails 2 1/2" depth, 60 cubic in.	25	7.92
CARB120R	1-gang box, old work case, 3 5/8" depth, 20 cubic in.	50	3.31
CARB225R-UPC	2-gang box, old work case, 2 3/4" depth, 25 cubic in.	30	5.95
CARB355R	3-gang box, old work case, 3 11/16" depth, 55 cubic in.	6	10.95
CARB520A-UPC	Ceiling box with nails, 4" dia., 20 cubic in.	75	2.15

Flexible Electrical Non-metallic Tubing



CAR12005-200

Part No.	Color	Nom. I.D.	Nom. O.D.	Min. Bend Radius	Coil Length (ft.)	Wt. per 100 ft. (lbs.)	Price per roll
CAR12005-200	Blue	0.56	0.84	6"	200	10	127.40
CAR12005Y-200	Yellow	0.56	0.84	6"	200	10	147.38
CAR12005R-200	Red	0.56	0.84	6"	200	10	149.88
CAR12007-100	Blue	0.76	1.05	6"	100	14	88.68
CAR12007Y-100	Yellow	0.76	1.05	6"	100	14	101.17
CAR12007R-100	Red	0.76	1.05	6"	100	14	113.66
CAR12008-100	Blue	1	1.315	6"	100	22	133.64
CAR12008Y-100	Yellow	1	1.315	6"	100	22	153.63
CAR12008R-100	Red	1	1.315	6"	100	22	218.58

Flexible Electrical Non-metallic Tubing Accessories

		Carton Qty.	Price each
CARA240D	1/2" ENT quick connector adapter	150	1.06
CARA243D	1/2" ENT quick connector threaded adapter	150	1.61
CARA253D	1/2" ENT quick connector snap-in adapter	150	1.12
CARA240E	3/4" ENT quick connector adapter	100	1.41
CARA243E	3/4" ENT quick connector threaded adapter	100	2.89
CARA253E	3/4" ENT quick connector snap-in adapter	100	2.00
CARA240F	1" ENT quick connector adapter	50	2.65
CARA243F	1" ENT quick connector threaded adapter	50	4.60
CARA253F	1" ENT quick connector snap-in adapter	50	3.09
CARE940D	1/2" ENT standard coupling	150	0.20

		Carton Qty.	Price each
CARE943D	1/2" ENT male term. adapter	150	0.27
CARE940E	3/4" ENT standard coupling	100	0.26
CARE943E	3/4" ENT male term. adapter	125	0.45
CARE940F	1" ENT standard coupling	50	0.40
CARE943F	1" ENT male term. adapter	50	0.61



CARA240D



CARA243D



CARA253D



CARE943D



CARE940F

No Minimum Purchase is Required.

LED Lighting

LED Bulbs and Fixtures



BL210836

BL210836	Wall-mount solar sensor LED light, 4-pack	31.18
----------	-------------------------------------------	-------



BL210837

BL210837	Wall-mount outdoor security light with solar panel	22.79
----------	----------------------------------------------------	-------



BL210876

BL210876	7W, 2700K Edison style dimmable LED bulb, 60W equivalent, 6-pack	17.47
----------	------------------------------------------------------------------	-------



BL210848

BL210848	2'x2' LED panel, 40W, 5000K, 4000Lm - 2-pack	94.36
----------	----------------------------------------------	-------



BL210850

BL210849	1'x4' LED panel, 40W, 5000K, 4000Lm - 2-pack	88.36
----------	----------------------------------------------	-------

BL210850	2'x4' LED panel, 40W, 5000K, 4000Lm - 2-pack	180.90
----------	----------------------------------------------	--------

LED panels mount in ceiling tile grid. Lm = Lumens



Structured Cable Management Systems

		Case	Each
AIINM904	Snap-in blank for knockouts, 1½", gray plastic	25	0.36
AIISB130	Bushing, non-metallic for metal studs, fits standard 1" knockout	100	0.20
AII4404	Snap-in bushing for knockouts, 1½", gray plastic	250	0.25
AIIBC25	1/4" beam clamp for use with the above two cable hangers	25	0.69
AIILV1	Low-voltage mounting bracket, old work, single gang, plastic, adj. ¼" - 1" walls	100	0.93
AIILVA1	Adjustable depth 1-gang low-voltage mounting bracket for new construction	25	2.09
AIILV1RP	Super sturdy low-voltage mounting bracket, old work, single gang, plastic, adj. ¼" - 1" walls	25	1.97
AIILV2	Low-voltage mounting bracket, old work, double gang, plastic, adj. ¼" - 1" walls	50	1.40
AIILVA2	Adjustable depth 2-gang low-voltage mounting bracket for new construction	10	2.66
AIILV2RP	Super sturdy low-voltage mounting bracket, old work, double gang, plastic, adj. ¼" - 1" walls	10	3.17
AIILV3	Low-voltage mounting bracket, old work, 3-gang, plastic, adj. ¼" - 1" walls	50	2.37
AIILV4	Low-voltage mounting bracket, old work, 4-gang, plastic, adj. ¼" - 1" walls	50	3.96
AIILVMB1	Low-voltage mounting bracket, new construction, single gang, plastic	100	0.78
AIILVMB2	Low-voltage mounting bracket, new construction, double gang, plastic	50	1.34
AIILVS1	Screw-on new construction bracket, single gang, low-voltage mounting bracket	50	0.54
AIILVN1	Nail-on new construction bracket, single gang, low-voltage mounting bracket	50	0.50
AIILVR1	Low-voltage mounting bracket, old work, round, plastic, adj. ¼" - 1" walls	25	1.55
AIIBE1	Single-gang box extender, add up to 1½" to boxes set back from wall surface	25	1.10
AIIBE2	Double-gang box extender, add up to 1½" to boxes set back from wall surface	25	1.53
AIISP100	Safety plate, flat 16 gauge steel, 1½" x 2¾"	100	0.16
AIIDVFR1W	Indoor IN BOX, recessed single gang box, great for kitchens/behind furniture	4	7.13
AIIDVFR2W	Indoor IN BOX, recessed double gang box, great for kitchens/behind furniture	4	11.66
AIITVB613	TV Box, recessed double gang electrical box with 2 low voltage knock outs	1	12.39
AIITVBU505	TV Box recessed power/low voltage box, old work. Includes box, receptacle, CEDH1 and wallplate	4	9.64
AIITVBU507*	TV Box, 3-gang recessed with 1 power and 2 low-voltage openings. *B-Black (leave off for White)	1	10.49
AIIT205	CableWay, cable runway support system, 5 foot trough for line or low voltage	10	12.59
AIIT23A	CableWay, cable runway support system, 90 degree fitting for corners	10	4.60
AIIT23C	CableWay, cable runway support system, coupling for joining T205	10	1.24
AIIT23E	CableWay, cable runway support system, end cap for terminating T205	10	0.99
AIIT23H	CableWay, cable runway support system, hanger bracket for T205	10	1.64
AIIT23T	CableWay, cable runway support system, "T" adapter	10	7.13



AIILV1

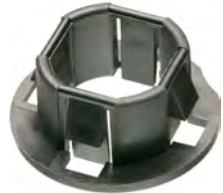

AII4404



AIIDVFR1W



AIIBE2

The Scoop Series Entrance Plates and Hoods

AIICE1	Single-gang, reversible-White	1.45	AIICE1BL	Single-gang, reversible-Black	1.44
AIICE2	Double-gang, reversible-White	2.20	AIICE2BL	Double-gang, reversible-Black	2.09
AIICER1	CE1 w/ removable plate-White	1.89	AIICER1BL	CE1 w/ removable plate-Black	1.80
AIICER2	CE2 w/ removable plate-White	2.52	AIICER2BL	CE2 w/ removable plate-Black	2.52
AIICED1	Single-gang reversible, decorator style-White	1.37	AIICED1BL	Single-gang reversible, decorator style-Black	1.44

Weatherproof Covers

AIIDBK88C	Weatherproof, non-metallic keypad enclosure, 7-1/4" x 7-3/4" x 1-1/2"-Clear	11.80
AIIDBK88W	Weatherproof, non-metallic keypad enclosure, 7-1/4" x 7-3/4" x 1-1/2"-White	11.80
AIIDBPH1C	Horizontal while-in-use cover for outlets-Clear	9.52



AIIDBPH1C

D-Rings

AIID22	Non-damaging wire management ring, 2.25" x 2"	1.05
AIID33	Non-damaging wire management ring, 3.25" x 3.25"	1.15
AIID35	Non-damaging wire management ring, 3.25" x 5"	1.54



D-Rings

Structured Cable Management Systems (No Upcharge for Broken Cases)

CARSC100A



CARSC300PRB

		Case	Each
CARSC100A	Single-gang low-voltage bracket	24	1.20
CARSC100ADJC	Single-gang adjustable low-voltage bracket, cut-off	24	3.04
CARSC100RR	Single-gang old-work bracket, low-voltage	12	1.00
CARSC200A	Dual-gang low-voltage bracket	24	1.84
CARSC200ADJC	Dual-gang adjustable low-voltage bracket, cut-off	20	5.28
CARSC200DV	Dual-gang dual-voltage box	16	1.91
CARSC200RR	Dual-gang old-work bracket, low-voltage	6	2.29
CARSC300A	Triple-gang low-voltage bracket	5	3.27
CARSC300PRB	Triple-gang recessed dual voltage TV bracket	20	13.65
CARSC12CC	1/2" three wire stacking staples, 10 pack	10	5.57
CARSC14CC	1/4" coaxial staple, 10 pack	10	77.81

Resi-Gard Adapters (No Upcharge for Broken Cases)

CARSCA243E

		Case	Each
CARSCA240E	3/4" Resi-Gard quick connector adapter	25	0.87
CARSCA243E	3/4" Resi-Gard quick connector threaded adapter	25	1.42
CARSCA253E	3/4" Resi-Gard quick connector snap-in adapter	25	1.09
CARSCA240F	1" Resi-Gard quick connector adapter	20	1.48
CARSCA243F	1" Resi-Gard quick connector threaded adapter	20	1.90
CARSCA253F	1" Resi-Gard quick connector snap-in adapter	20	1.66

Resi-Gard Conduit (No Upcharge for Broken Cases)

CARSC943J



CARSC977JC



Resi-Gard

		Case	Each
CARSC4X1-100	3/4" Resi-Gard, 100'	1	57.10
CARSC4X1-1000	3/4" Resi-Gard, 1000'	1	512.09
CARSC977EC	3/4" Resi-Gard conduit clamp - 5 pack	20	1.77
CARSCF4X1C-100	1" Resi-Gard with tape, 100'	1	73.79
CARSCF4X1C-1500	1" Resi-Gard with tape, 1500'	1	861.81
CARSC977FC	1" Resi-Gard conduit clamp - 5 pack	12	3.17
CARSC4X1C-50	1 1/2" Resi-Gard with tape, 50'	1	53.08
CARSC977HC	1 1/2" Resi-Gard conduit clamp - 5 pack	6	3.55
CARSC940H	1 1/2" Resi-Gard standard coupling	25	0.69
CARSC943H	1 1/2" Resi-Gard male termination adapter	25	0.90
CARSCJ4X1C-50	2" Resi-Gard with tape, 50'	1	73.40
CARSCJ4X1C-500	2" Resi-Gard with tape, 500'	1	736.91
CARSC977JC	2" Resi-Gard conduit clamp - 5 pack	6	3.93
CARSC940J	2" Resi-Gard standard coupling	30	0.95
CARSC943J	2" Resi-Gard male termination adapter	50	1.21

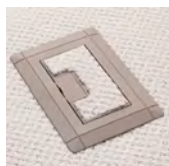
Floor Boxes - Priced per Case

CARE9761BR

		Case	Price
CARE976RFB	Rectangular floor box base assembly	3	202.19
CARE976AK2	Activation Kit 2, rectangular floor box	3	87.98
CARE9761BR	Cover assembly, single, brass	3	696.98
CARE9762BR	Cover assembly, double, brass	3	1,099.03
CARE9762S	Cover assembly, double, slate	9	1,289.57
CARE9763S	Cover assembly, triple, slate	6	1,117.66
CARB121BFBR	Single-gang adjustable residential floor box	8	493.01
CARB234BFBB	Dual-gang adjustable residential floor box	4	1,007.59

Tools

CARCC120B

CARCC120B	Small conduit cutter, for fast, smooth field cuts of 1/2" through 1" conduit	45.59
-----------	------------------------------------------------------------------------------	-------

Enclosures

CARNC664	6x6x4 NEMA enclosure with external hinged cover-clear. Meets NEMA 1, 2, 3, 3S, 3X, 3SX, 4, 4X, 12 standards.	291.08
CARNC16146	16x14x6 NEMA enclosure with external hinged cover-clear. Meets NEMA 1, 2, 3, 3S, 3X, 3SX, 4, 4X, 12 standards.	349.77

Are you looking for Fiber?

Leviton will manufacture custom made fiber bundles with all connectors attached. They even attach the pull-sock. Prices are custom quoted, so please have your detailed needs.



Call

HDMI over Cat 6

Cat 5e distribution allows you to use inexpensive UTP wire to distribute HDMI to locations where the proper wire is either not available or not cost-effective. As signal quality increases, Cat 6e becomes a better choice due to more bandwidth.



Pages 168-169

For all your cabling needs.

From 22/2 for security to RG6 for CATV/Satellite as well as direct burial wire for your landscape lighting, Wavenet has cable to fit almost all applications. Please call us if you have questions when specifying wire.



Pages 214-215

Interconnect Cables

Connect all of your A/V gear with these quality cables. Different levels of quality are available to suit any customers' needs. Please give us a call with questions regarding what interconnect cables to use.



Page 172

Distributed Audio Systems



Run 16/4 and Cat 5 to the keypad and then 16/2 from there to each speaker you have prewired for C-Series, MRC88, M4, LyriQ, Hi-Fi 2 or A-BUS.

Speaker Cable



Use 16-gauge for runs under 100' and 14-gauge for home theaters or runs over 100.'



Telephone

Cat 5e has become the standard wire to run for both telephone and home networking.



Networking

Cat 6 is available for high bandwidth. Fiber is generally not used for networking at this time. Fiber can be used to connect two buildings.



Security

Most keypads are 22/4, but touchscreens are frequently looking for Cat 5. Use 22/2 for door/window sensors and 22/4 for powered devices, such as motion detectors and glass breaks.



Fire Alarm

Red fire-wire is required for code. For a home fire system, you must run fire wire to all fire detectors, fire alarm sounders, the transformer, keypads and powered devices.

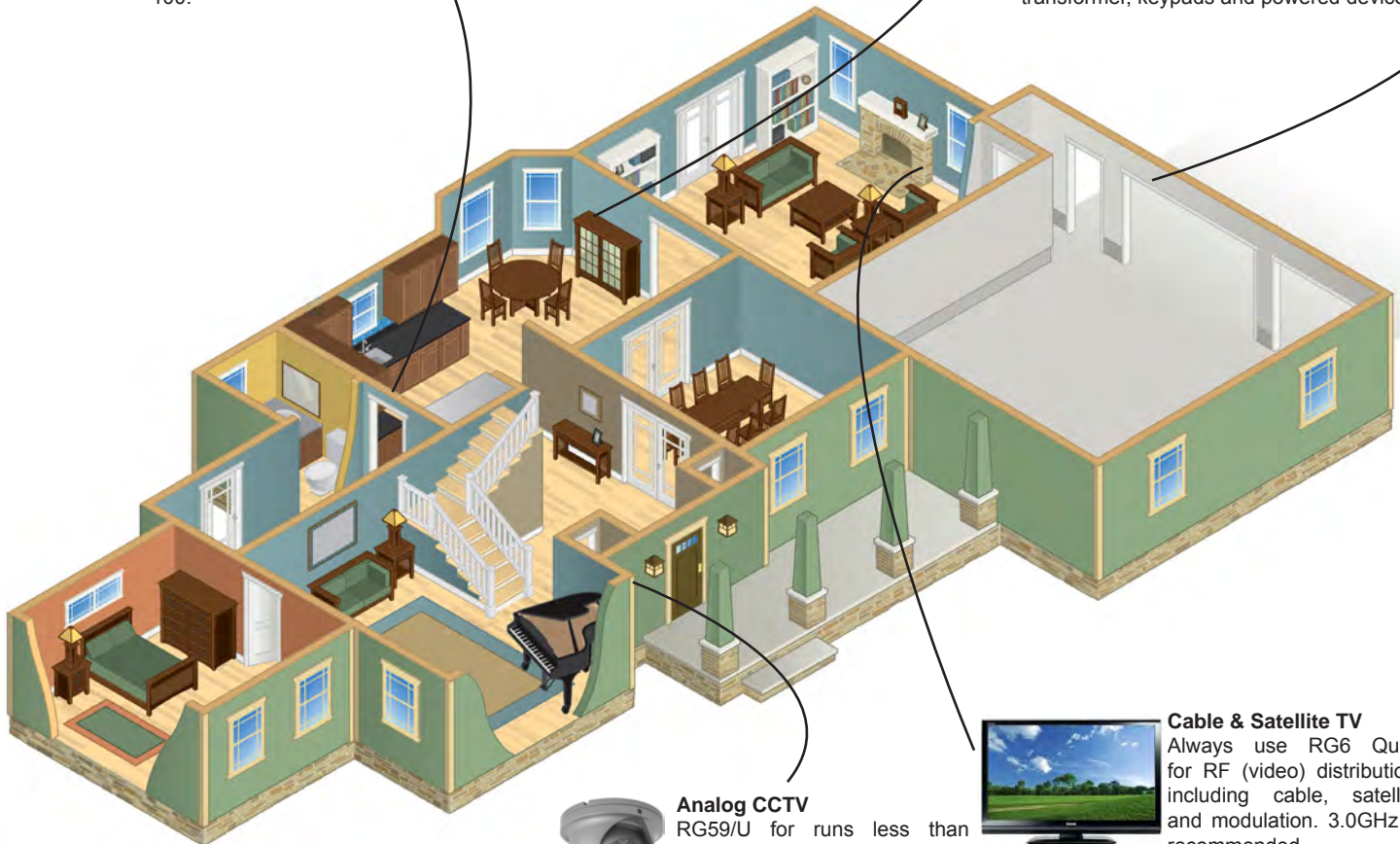

Analog CCTV

RG59/U for runs less than 750 feet. RG6/U (solid copper center) for runs less than 1,500 feet. 18/2 is common for the power wire. If you are using baluns, you can use Cat 5e, up to 2200 feet.



Cable & Satellite TV

Always use RG6 Quad for RF (video) distribution, including cable, satellite and modulation. 3.0GHz is recommended.

Wire and Cable Ordering Options

Put-up and color availability vary by part (prices shown per 1000' unless otherwise noted)

Put-up (packaging) [Please note: reels (2) are charged additional "no-box fee" by UPS/FedEx]

** - Colors WH-White, YL-Yellow, OR-Orange, GN-Green, BL-Blue, BK-Black, GY-Gray, PR-Purple, PK-Pink, RD-Red

Type Defines how and where the cable can be used. In most cases the higher type of wire can be substituted for the lower type.
 CM = communications wire usually in a cable tray, CL3 = in-wall rated for residential use, CMR = verticle riser-rated for commercial use,
 CMP = Commercial ceiling airspaces, STP, PE, FPLR = Fire Alarm cable, CMX = Outdoor



Wire pricing is always subject to change due to market fluctuations in copper.



Cat 5e for Network, Phone, Intercoms, etc. (1000' only)

WAV5E04UR**1	Standard PVC Cat 5e: 24AWG, 4 pair, 350MHZ	CMR	(BK, BL, GN, GY, OR, PK, PR, RD, WH, YL)	1000' Pull Box	71.19
WAV5E04UP3**	Plenum Cat 5e, 24AWG, 4 pair, 350MHZ	CMP	(BL, GN, GY, OR, RD, WH)	1000' RIB	147.38
WAV5E04SR**	Shielded PVC Cat 5e: 24AWG, 4 pair, shielded, 350MHZ	CMR	(BL, GY, WH)	1000' Pull Box	143.64
WAV5E04FP**3	Shielded Plenum Cat 5e: 24AWG, 4 pair, shielded, 350MHZ	CMP	(BL, WH)	1000' RIB	307.25
WAV5E04UR**1-S	Stranded Conductor PVC Cat 5e: 24AWG, 4 pr, stranded, 350MHZ	CMR	(BK, BN, BL, GN, GY, OR, PK, PR, RD, WH, YL)	1000' Pull Box	102.42
WAV5E0SPBK2	Direct Burial Cat 5e: 24AWG, 4 pair, direct burial, 350MHZ	CMX	(BK)	1000' Reel	126.15
WAV5E0SPGBK2	Direct Burial Cat 5e: Gel PE, 24AWG, 4 pair, direct burial, 350MHZ	CMX	(BK)	1000' Reel	131.14
WAV5ESOSPBK	Shielded Direct Burial Cat 5e:24AWG, 4 pair, direct burial, 350MHZ	CMX	(BK)	1000' Reel	189.95
WAV5E25URGY2	PVC 25 Pair Cat 5e: 24AWG, 25 pair	CMR	(GY)	1000' Reel	612.01

Cat 6 for Network (1000' only)

WAV6E04UR**3	PVC Cat 6: 23AWG, 4 pair, 550MHZ	CMR	(BL, GN, GY, RD, WH, YL)	1000' RIB	111.16
WAV6E04UP**3	Plenum Cat 6: 23AWG, 4 pair, 550MHZ	CMP	(BL, GN, GY, RD, WH, YL)	1000' RIB	231.06
WAV6E04SR**2	Shielded PVC Cat 6: 23AWG, 4 pair, shielded, 550MHZ	CMR	(BL, GY, WH)	1000' RIB	178.61
WAV6E0SPBK2	Direct Burial Cat 6: 23AWG, 4 pair, outdoor, 550MHZ	CMX	(BK)	1000' Reel	173.61
WAV6E0SPGBK2	Direct Burial Cat 6: Gel PE, 23AWG, 4 pair, outdoor, 550MHZ	CMX	(BK)	1000' Reel	173.61
WAV6ESOSPBK	Shielded Direct Burial Cat 6: 23AWG, 4 pair, outdoor, 550MHZ	CMX	(BK)	1000' Reel	211.08
WAV6A04UR**2	PVC Cat 6A: 23AWG, 4 pair	CMR	(BL, GY)	1000' Reel	204.84
WAV6A04UPBL2	Plenum Cat 6A: 23AWG, 4 pair	CMP	(BL)	1000' Reel	527.08

Broadband COAX

WAVRG6QR**1	Quad Shield PVC RG6: 18AWG, CCS, 3.0GHZ	CMR	(BK, WH)	1000' Pull Box	173.61
WAVRG6QOSPBK2	Direct Burial Quad Shield RG6: 18AWG, CCS, 3.0GHZ	CMR	(BK)	1000' Reel	69.94
WAVRG6QPWH1	Plenum Quad Shield RG6: 18AWG, CCS, 3.0GHZ	CMP	(WH)	1000' Pull Box	316.00
WAVRG6UR**1	PVC Dual Shield RG6: 18AWG, 60% shield, CCS, 3.0GHZ	CMR	(BK, WH)	1000' Pull Box	46.21
WAVRG6OSPBK2	Direct Burial RG6: 18AWG, 60% shield, CCS, 3.0GHZ	CMX	(BK)	1000' Reel	59.95
WAVRG11RBK2	PVC RG11: 14AWG, 1.0GHZ	CMR	(BK)	1000' Reel	128.65
WAVRG11PWH2	Plenum RG11: 14AWG, 1.0GHZ	CMP	(WH)	1000' Reel	776.88



WAVH59182BCRBK2



WAVAC1604RWH15



WAVH25E26QMBL2



WAVPW18SM

Would You Like Free Freight on Wire?

Order your wire in bulk (minimum order is \$3125.00.) and get FREE ground freight shipping (drop shipped).
 You can mix Cat 5, RG-6, Combination Cable, Speaker/Fire Alarm/Security Wire in the same order.

CCTV and RG59 COAX

WAVH59182BCR**2	PVC Siamese CCTV Cable: RG59 95% bare copper + 18/2	CMR	(BK, WH)	1000' Reel	172.36
WAVH59182BCR**3	PVC Siamese CCTV Cable: RG59 95% bare copper + 18/2	CMR	(BK, WH)	500' RIB	89.93
WAVH59+182PWH2	Plenum Siamese CCTV Cable: RG59 95% bare copper + 18/2	CMP	(WH)	1000' Reel	313.50
WAVH59+182PWH3	Plenum Siamese CCTV Cable: RG59 95% bare copper + 18/2	CMP	(WH)	500' RIB	164.87
WAVRG59R**1	RG59 95% PVC: 20AWG, 95% bare copper, 3.0GHZ	CMR	(BK, WH)	1000' Pull Box	76.19

Speaker Cable

WAVAC1602R**15	16/2 Audio Cable: 16AWG, 2C 65 strand oxygen free copper	CMR	(BK, WH)	500' Pull Box	66.20
WAVAC1602OSPBK4	16/2 Direct Burial Audio Cable: 16AWG, 2C 65 strand oxygen free copper	CMX	(BK)	500' Pull Box	76.19
WAVAC1604R**15	16/4 Audio Cable: 16AWG, 4C 65 strand oxygen free copper	CMR	(BK, WH)	500' Pull Box	122.40
WAVAC1604OSPBK1	16/4 Direct Burial Audio Cable: 16AWG, 2C 65 strand oxygen free copper	CMX	(BK)	500' Pull Box	128.65
WAVAC1402R**15	14/2 Audio Cable: 14AWG, 2C 105 strand oxygen free copper	CMR	(BK, WH)	500' Pull Box	99.92
WAVAC1402OSPBK1	14/2 Direct Burial Audio Cable, 2C 65 strand oxygen free copper	CMX	(BK)	500' Pull Box	106.16
WAVAC1404R**15	14/4 Audio Cable: 14AWG, 4C 105 strand oxygen free copper	CMR	(BK, WH)	500' Pull Box	187.35
WAVAC1404OSPBK1	14/4 Direct Burial Audio Cable: 14AWG, 4C 105 strand oxygen free copper	CMX	(BK)	500' Pull Box	194.84
WAVAC1202R**15	12/2 Audio Cable: 16AWG, 2C 65 strand oxygen free copper	CMR	(BK, WH)	500' Pull Box	157.37

Security Wire

WAVSC2202R**1	22/2 Solid Security wire, 22AWG/2C	CMR	(GY, WH)	1000' Pull Box	35.60
WAVSC2202RWH1-S	22/2 Stranded Security wire, 22AWG/2C	CMR	(WH)	1000' Pull Box	38.09
WAVSC2204R**1	22/4 Solid Security wire, 22AWG/4C	CMR	(GY, WH)	1000' Pull Box	59.95
WAVSC2204R**1-S	22/4 Stranded Security wire, 22AWG/4C	CMR	(GY, WH)	1000' Pull Box	68.70

Fire-Wire (Always Red)

WAVFC1802URD1	18/2 Unshielded Fire Alarm Riser-rated: 18AWG/2C fire alarm cable	FPLR	(RD)	1000' Pull Box	68.70
WAVFC1602URD1	16/2 Unshielded Fire Alarm Riser-rated: 16AWG/2C fire alarm cable	FPLR	(RD)	1000' Pull Box	143.64
WAVFC1402URD2	14/2 Unshielded Fire Alarm Riser-rated: 14AWG/2C fire alarm cable	FPLR	(RD)	1000' Reel	191.10
WAVFC1804URD1	18/4 Unshielded Fire Alarm Riser-rated: 18AWG/4C fire alarm cable	FPLR	(RD)	1000' Pull Box	191.10
WAVFC1604URD1	16/4 Unshielded Fire Alarm Riser-rated: 16AWG/4C fire alarm cable	FPLR	(RD)	1000' Pull Box	191.10
WAVFC1402SRD2	14/2 Shielded Fire Alarm Riser-rated: 14AWG/2C fire alarm cable	FPLR	(RD)	1000' Reel	208.58
WAVFC1804SRD1	18/4 Shielded Fire Alarm Riser-rated: 18AWG/4C fire alarm cable	FPLR	(RD)	1000' Pull Box	177.36
WAVFC1604SRD2	16/4 Shielded Fire Alarm Riser-rated: 16AWG/4C fire alarm cable	FPLR	(RD)	1000' Reel	264.79

Wire pricing is always subject to change due to market fluctuations in copper.

Power Cables

WAVPW18SM	18/2 7-Strand Shielded PVC: 18AWG/2C	CMR	(GY)	1000' Pull Box	96.17
WAVPW18UM**1	18/2 7-Strand Unshielded PVC: 18AWG/2C	CMR	(GY, WH)	1000' Pull Box	89.93

Combination Cables

WAVH15E164MYL2	1 Cat 5e + 16/4 Audio Cable PVC: CAT 5e + 16/4 audio cable	CM	(YL)	500' Reel	178.61
WAVH15E16QMBL2	1 Cat 5e + 1 RG6Q PVC: Cat 5e + RG6Q	CM	(BL)	500' Reel	80.56
WAVH25E26Q2FYL2	2 Cat 5e + 2 RG6Q + Fiber PVC: Cat 5e + RG6Q + Fiber	CM	(YL)	500' Reel	323.49
WAVH25E26QMBL2	2 Cat 5e + 2 RG6Q PVC: 2 Cat 5e + 2 RG6Q	CM	(BL)	500' Reel	212.33
WAVH26E26QMGN2	2 Cat 6e + 2 RG6Q PVC: 2 Cat 6e + 2 RG6Q	CM	(GN)	500' Reel	256.04

Always follow local, state, and national codes and adhere to professional wiring practices.

Order your wire in bulk (minimum order is \$3125.00.) and get FREE ground freight shipping (drop shipped).

You can mix Cat 5, RG-6, Combination Cable, Speaker/Fire Alarm/Security Wire in the same order.

ORDERING: A toll free call to 1-800-282-8864 connects you to our knowledgeable sales team who seeks to provide you with the information, support and products you need to provide your clients with total solutions. We will gladly provide you with quotations, product information and technical assistance. Our business hours (Eastern Time) are 7:30 am to 6:00 pm Monday through Friday. **Orders can be placed 24 hours via toll free fax at 1-866-542-0470, on our after-hours voice mail order desk at our toll free number, 1-800-282-8864, at our secure dealer web site: www.worthdist.com, or by e-mail to sales@worthdist.com.** We do not have a minimum order.

SAME DAY SHIPPING: All orders placed by 4:00 pm Eastern Time (Monday - Friday) will be shipped the same day, F.O.B. Tafton, PA, based on product availability. Our standard methods of shipping are UPS and FedEx Ground. Guaranteed two-day, overnight and Saturday delivery are available for time sensitive orders at an additional fee. US Mail Priority and Parcel Post shipping is also available to some areas.

PAYMENT TERMS: We accept VISA, MasterCard, Discover and American Express with no additional charge for credit card payment. We will also ship C.O.D. certified check with prior approval. Please note, FedEx and UPS do not accept cash C.O.D. payments. The carrier's C.O.D. fee will be added to all C.O.D. orders. Our credit application is located on pages 193 and 194. All portions of the credit application **MUST** be completed and signed. Partially completed credit applications cannot be processed. A credit application is not required for credit card orders. A \$25 fee will be charged for any returned check. Prepaid orders from international customers are welcome. Payment options include wire transfer, money order, secured check and PayPal. Additional fees may apply.

INSURANCE: Orders under \$100 are automatically insured by FedEx or UPS. Orders greater than \$100 will incur an additional insurance fee.

REFUSALS/INCORRECT ADDRESS: Any orders that are refused or are undeliverable will be charged shipping fees to the customer and return shipping fees to Worthington Distribution, plus a restocking fee of 10% of the invoiced amount. FedEx and UPS impose an address correction fee, which Worthington Distribution will bill you for if an incorrect address is given at time of order. This includes, but is not limited to, incorrect street address, missing suite/apartment numbers, or incorrect ZIP code. To avoid both this charge and shipping delays, please confirm accurate shipping information at time of order.

DROP SHIPMENTS: We can ship directly to your job site or client as requested. Please make sure that someone will be available to sign for the package(s) or arrange for a signature release on file with the carrier. Manufacturer special orders, large orders and expedited orders may also be drop shipped directly from the manufacturer to your location. Although Worthington Distribution does not charge for drop shipments, please note that several manufacturers do charge a drop ship fee. You will be billed separately for any incurred drop ship fees and shipping costs.

BILLING/SHIPPING DISCREPANCIES: Shipping or billing discrepancies (misshipped items, missing items, incorrect charges, etc.) must be brought to our attention within **5 days of receipt of package**.

DAMAGED IN SHIPPING: When you receive your merchandise, please open all boxes immediately to check for contents and/or damage. Every effort is made to pack your goods to prevent damage during shipping; however, if damage does occur, you must notify Worthington Distribution within **5 days of receipt of package**. We will file a claim with the carrier, and upon credit from the carrier, we will issue credit to you. FedEx and UPS reserve the right to inspect packaging and damaged products; packaging and product must be made available for inspection at the delivery address. If your package arrives visibly damaged, please ask your courier to make a note of the damage at time of delivery.

DEFECTIVE RETURNS: Although Worthington Distribution understands how exasperating it is to receive a defective product, we must adhere to all **manufacturer warranty requirements**. Therefore, in accordance with the manufacturer's terms and conditions, the manufacturer has the right to repair or replace defective product at their discretion. Some manufacturers will handle these returns directly. Upon manufacturer's approval we will replace defective products returned to us within 30 days of the invoice date. Defective products **must** be returned in the manufacturer's original packing, and the carton **must** include **all** components and other items originally packaged with the product, including all manuals, etc. **Do not write on or use the product box as a shipping box**. You pay shipping to us, and we will pay for domestic return shipping to you via UPS Ground. Many manufacturers reserve the right to return your product to you, should the product prove to be operational; in these cases credit will not be issued for the product, and return shipping fees will be billed to you. Please feel free to contact us for free technical assistance and troubleshooting if you feel you have received a defective item. Please note that some manufacturers require factory troubleshooting prior to RMA issuance.

ALL RETURNS: **There are no returns on special order merchandise.** All return requests must be made within **30 days** from date of purchase. During this 30-day period, all new and unused products that are currently manufactured, in their original packaging with all hardware and manuals, and in resellable condition, can be returned without a restocking fee; **installed items cannot be returned**. You must pay shipping to us. Product not meeting these criteria, in most cases, cannot be returned or is subject to a restocking fee. Due to copyright laws, software, books, and manuals are not returnable. Wire and conduit are also not returnable. Shipping charges are not refundable and returns must be sent to Worthington Distribution freight prepaid. Worthington Distribution is not responsible for returns lost or damaged during shipping. **Our RMA request form must be completed before an RMA number is issued.** To obtain an RMA request form, contact us at 1-800-282-8864, or you can download the RMA form at www.worthdist.com>Returns. RMA numbers are issued to ensure proper credit is applied or replacement product is handled correctly. You must write the RMA number on the outside of the shipping package you are returning, not on the manufacturer's package. RMA numbers are valid for **15 days** from date of issue. Returns without an RMA number on the box are subject to refusal. **Note: It is the customer's responsibility to verify compatibility and customer commitment prior to ordering and installing any items. Store credit must be used within one year from date of return.**

PRICING: Prices in this catalog supersede all previous pricing. Although catalog price is generally held, prices may change due to market fluctuation. This can result in lower pricing to you, our valued customer. Prices and specifications are subject to change without notice. We are happy to provide written quotes for your upcoming jobs. Quotes are valid for 30 days from date of issuance. Please log in to the dealer store at www.worthdist.com for the most current pricing.

DISCLAIMER: Although every effort has been made to ensure the integrity of this publication, occasional omissions, typographical errors or misprints do occur. Worthington Distribution cannot be held responsible for any misrepresentation associated with any product or price in this publication. All trademarks and registered trademarks are the property of their respective companies. No portion of this publication may be reproduced without express written permission from Worthington Group, Ltd.

Placing an order with Worthington Distribution indicates acceptance of these terms and conditions.

Expand Your Marketplace



XZone70V

70/100V Streaming Mixer Amplifier

The all-in-one solution for all of your light commercial jobs

AW70V6

70v Surface Mount Indoor/Outdoor Speakers

Easy to install, easy to adjust, perfect for every job, indoors or out

ALT-70V-50

50-Watt 70V Volume Control

Ultra-reliable and designed for years of use

www.russound.com

WORTHINGTON

DISTRIBUTION

566 RT 390 • TAFTON, PA 18464

PRESORTED
BOUND PRINTED MATTER
U.S. POSTAGE
PAID
RIPON, WI
PERMIT NO 100

speco technologies

FORTREZ Z

Dakota Alert, Inc.

Yale

cartell
vehicle detection

LEVITON
Security & Automation

LUTRON

Global Parks

legrand

JASCO
DSC

somfy

LUXUL
WIRELESS

arlo

Russound

FIBARO
Home intelligence

zipato

Sillites

iPort

SCHLAGE

DÔME

MCO HOME

ELK

2gig technologies

PROFICIENT

HomeSeer

CENTRALITE

GRANDSTREAM
CONQUERING THE WORLD

CALL 800-282-8864 • VISIT US WORTHDIST.COM



WORTHINGTON UNIVERSITY

TRAINING

- ✓ Custom trainings - we fit the training to the products and technologies that you want to learn about
- ✓ Live webinars
- ✓ Online knowledge base featuring articles from our In-house experts
- ✓ Hands-on classroom remodeled with the latest products and systems
- ✓ Class led by industry veterans with years of experience
- ✓ 9 workstations fitted with full automation systems provide hands-on experience
- ✓ Extensive training on lighting systems using the latest communication technologies

TECHNICAL SALES STAFF

- ✓ Hands-on and field experienced
- ✓ Unparalleled pre-sales design assistance and technical support after the sale
- ✓ We use the experience we have gained with thousands of dealers nationally to help each dealer individually
- ✓ Our Technical Sales staff has access to a lab with many of the products you use every day

WWW.WORTHINGTONU.COM

NATIONAL DISTRIBUTOR | WWW.WORTHDIST.COM | 800-282-8864